

ADDITIONAL INFORMATION

WARRANTY TERMS

Novameta provides a Manufacturer's warranty for all of the equipment against defects in materials and workmanship for a period of 1 year from the date of shipment. Manufacturer undertakes to replace all inferior parts to proper quality parts or materials. In case of a fault, a properly filled claim is required and must contain all essential information relative to the fault. Faulty parts shall be returned to Manufacturer for further inspection. The producer does not take any responsibility for damages that occur due to ignorance of cautions, improper maintenance or mechanical damages of the unit, including those, caused during the delivery. This warranty is not effective if damage occurs from improper installation, misuse; incorrect voltage supply, wear and tear from normal usage, accidental breakage, damage or if the equipment is operated contrary to the user instructions. Any expenses in connection with the installation or costs of making adjustments (including service procedures, travel time costs) on the equipment to comply with the supply at the point of installation are not covered by this warranty. The warranty does not cover if the damage occurs due to natural disasters; fire, if repair service was made by unauthorized person.

DELIVERY RECOMMENDATIONS

Upon receipt, inspect units immediately for any shipping damage and notify carrier immediately if damage is found. It must be reported IMMEDIATELY (upon delivery) in writing in the CMR. All items are thoroughly inspected and carefully packed before leaving our factory, thus Novameta cannot accept responsibility for any shipping damage, however Novameta will assist in filing a claim.

ACCESSORIES

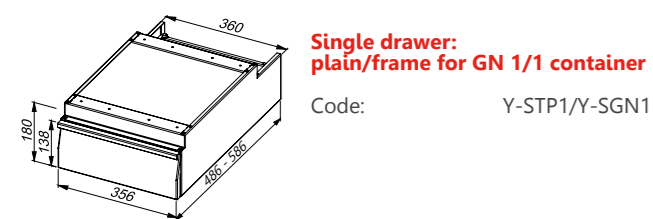

Single drawer: plain/frame for GN 1/1 container
Code: Y-STP1/Y-SGN1

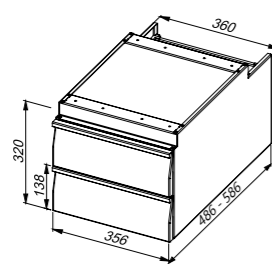

Double drawer block: plain/frame for GN 1/1 container
Code: Y-STP2/Y-SGN2

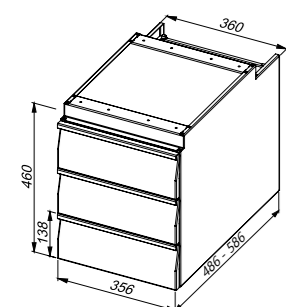

Triple drawer block: plain/frame for GN 1/1 container
Code: Y-STP3/Y-SGN3

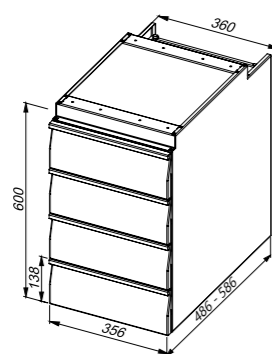

Quadruple drawer block: plain/frame for GN 1/1 container
Code: Y-STP4/Y-SGN4

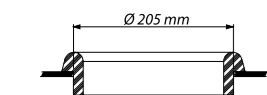

Waste hole Ø205 mm (rubber ring)
Code: K-FGA-D205

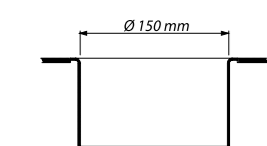

Stainless steel waste hole (ø150, ø200 or ø250 mm)
Code: Y-SNA-150

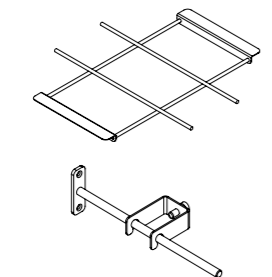

Sliding grid for sink
Code: Y-SGP

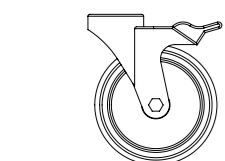

Set of galvanized wheels Ø125 mm (4 pcs), 2 pcs with stopping device, "Blickle" – Germany
Code: K-RAX125-157NCG

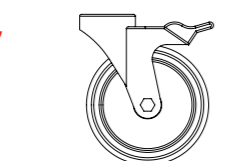

Set of stainless steel wheels Ø125mm (4 pcs), 2 pcs with stopping device, "Blickle" – Germany
Code: K-RAX125-157NNG

TABLE TOP PROFILES

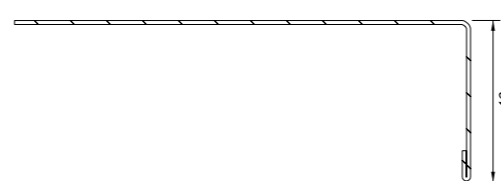

Flat table top
Code: DP

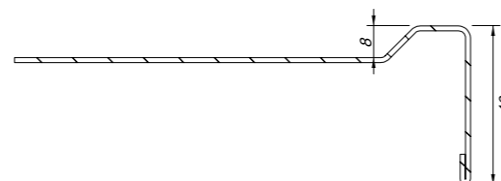

Deepened table top
Code: DG

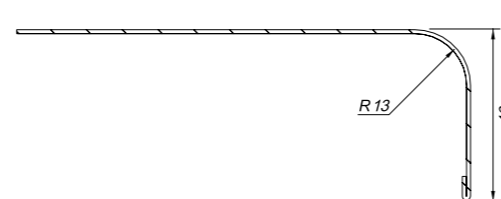

Rounded front edge
Code: Z-UP

UPSTANDS

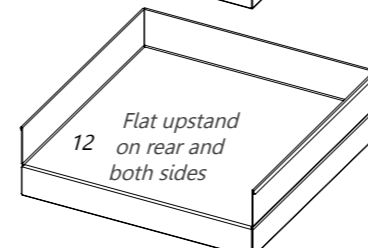
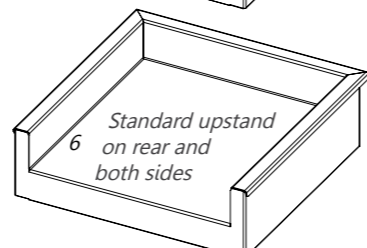
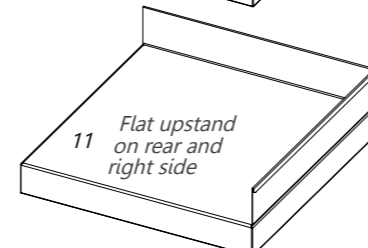
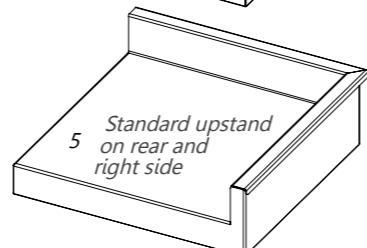
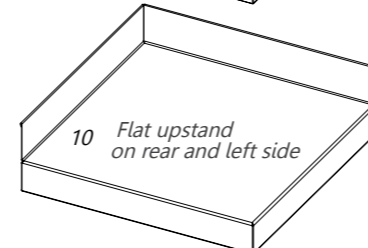
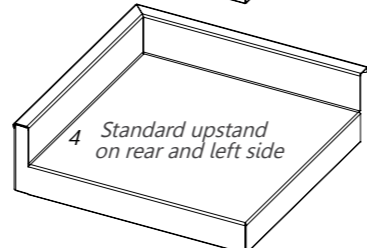
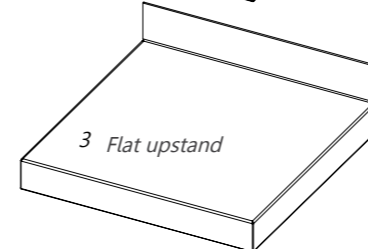
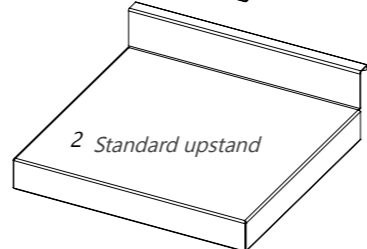
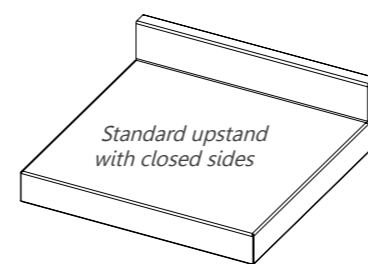
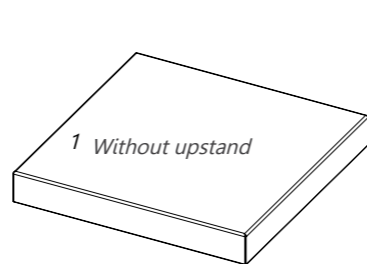

SINK PLUMBING SETS

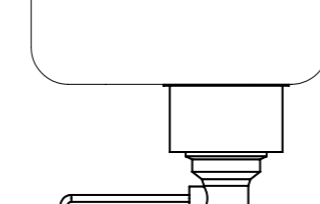
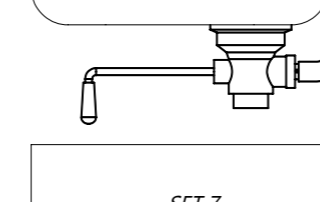
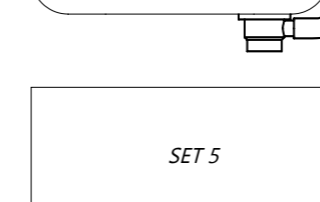
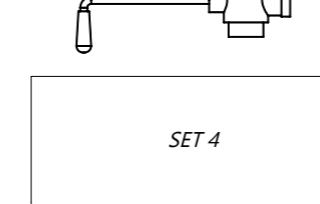
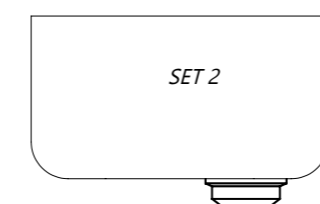
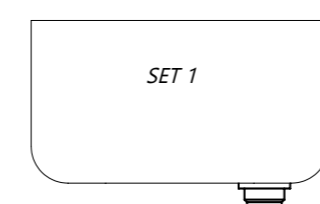

SINKS

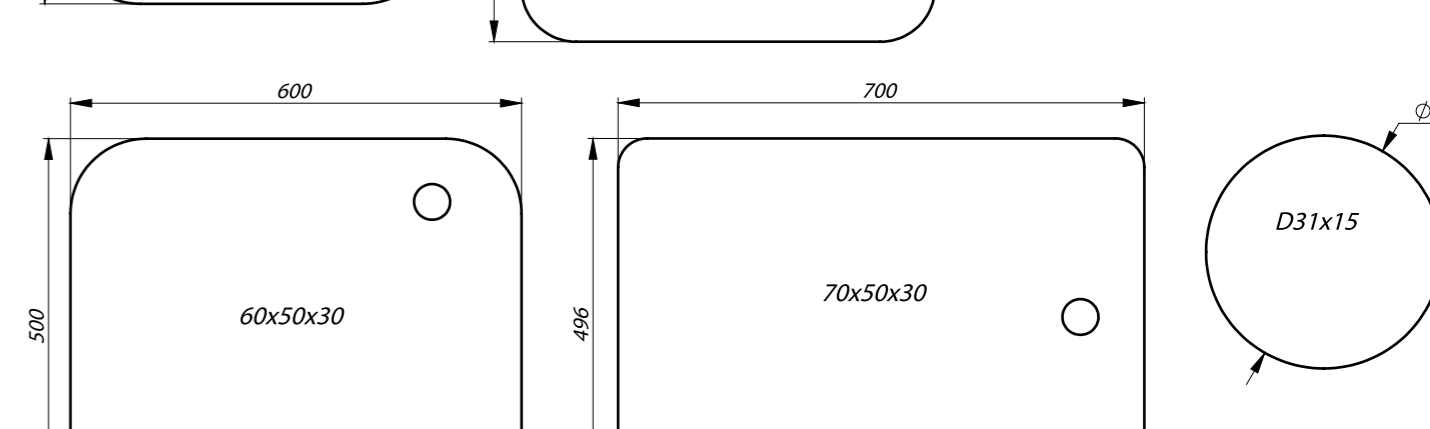
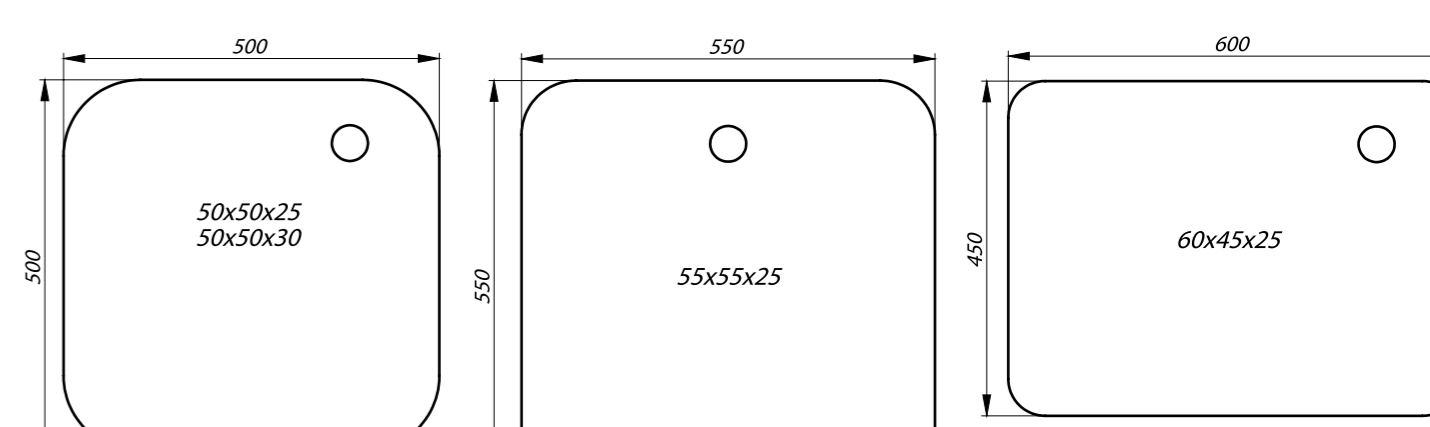
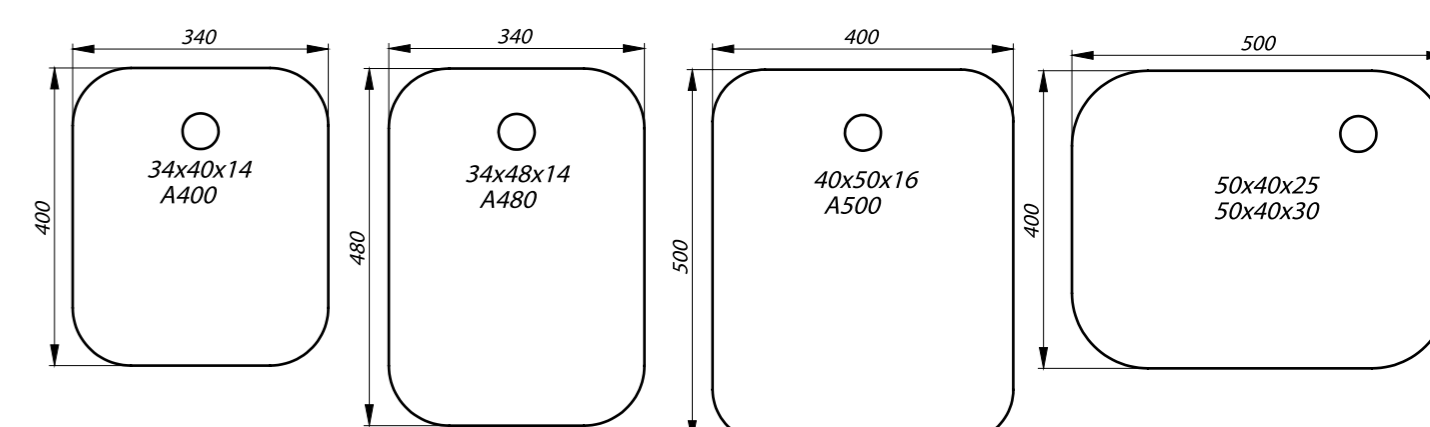
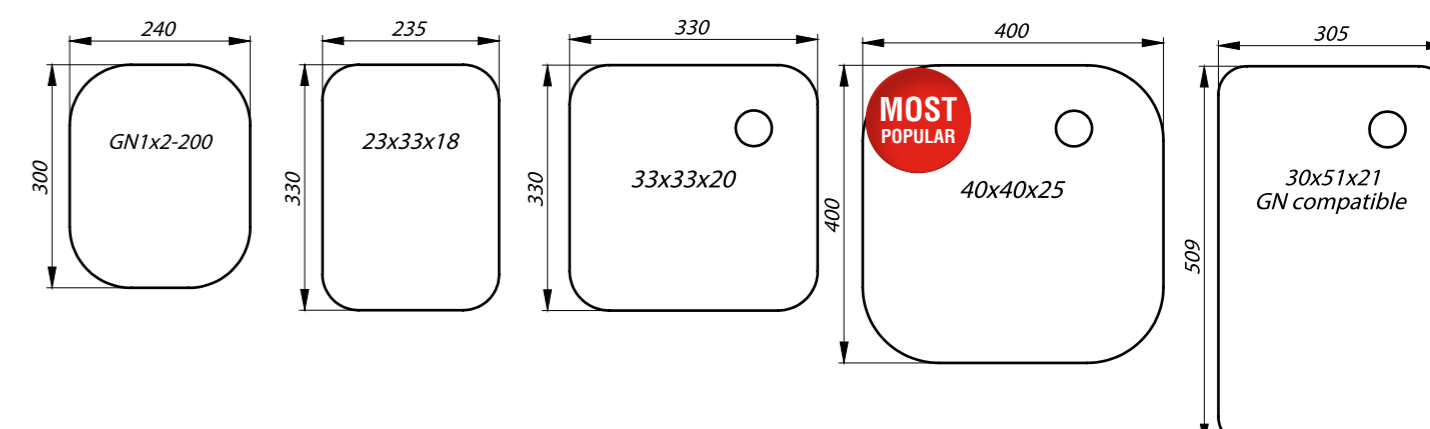

CUSTOM SIZES ARE AVAILABLE