

**Build in induction hobs with induction generator cabinet installed in a separate stainless steel box**

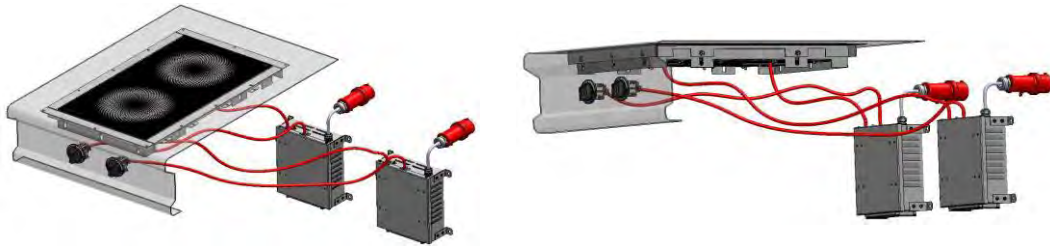

The induction generator is installed in a separate stainless steel box which already is included in the kit.  
The induction generator must be installed in such a way as to allow easy access and to ensure a good air supply.

**Single hobs**

**MS-I-10 EME**

**Eco hob with induction generator box**

Item no.	<b>123557</b>
Dimension of glass	388 x 388 x 6 mm
Size of cutout	392 x 392 mm
Cooking zone	Round eco coil
	<b>SLIDE CONTROL</b> technology
Effective field	260 mm
Power	3.5 kW
Connected load	1x230 VAC, 50/60 Hz
Plug	CEE 16 (LNPE) or type 23



**MS-I-10 EMP**

**Power hob with induction generator box**

Item no.	<b>120721</b>
Dimension of glass	388 x 388 x 6 mm
Size of cutout	392 x 392 mm
Cooking zone	Round power coil
	<b>SLIDE CONTROL</b> technology
Effective field	300 mm
Power	6 kW
Connected load	3x400-440 VAC, 50/60 Hz
Plug	CEE 16 (3LNPE) or type 15



**MS-I-10 EMM**

**Multifunction hob with induction generator box**

Item no.	<b>120722</b>
Dimension of glass	388 x 388 x 6 mm
Size of cutout	392 x 392 mm
Cooking zone	Multifunction coil
Effective field	340 x 360 mm
Power	7 kW
Connected load	3x400-440 VAC, 50/60 Hz
Plug	CEE 16 (3LNPE) or type 15



**MS-I-10 EMG**

**Full-coverage large hob with induction generator box**

Item no.	<b>120723</b>
Dimension of glass	388 x 388 x 6 mm
Size of cutout	392 x 392 mm
Cooking zone	Full-coverage coil
Effective field	380 x 380 mm
Power	9 kW
Connected load	3x400-440 VAC, 50/60 Hz
Plug	CEE 16 (3LNPE) or type 15



**MS-I-WOK 300 EME**

**Eco wok with induction generator box**

Item no.	<b>123996</b>
Dimension of glass	388 x 388 x 6 mm
Size of cutout	392 x 392 mm
Cooking zone	Eco wok coil
Effective field	300 mm
Power	3.5 kW
Connected load	1x230 VAC, 50/60 Hz
Plug	CEE 16 (LNPE) or type 23



**MS-I-WOK 300 EMP**

**Power wok with induction generator box**

Item no.	<b>120724</b>
Dimension of glass	388 x 388 x 6 mm
Size of cutout	392 x 392 mm
Cooking zone	Power wok coil
Effective field	300 mm
Power	5 kW
Connected load	3x400-440 VAC, 50/60 Hz
Plug	CEE 16 (3LNPE) or type 15



**Wok pan 300: Stainless steel with handle**

Item no.	<b>110466</b>
Wok-Ø	295 mm
Compatible with	MS-I-WOK 300
Volume	6 litre
Depth	130 mm

**Twin hobs****MS-I-20 EME 660****Eco twin power hob with induction generator box**

Item no.	<b>123563</b>
Dimension of glass	356 x 656 x 6 mm
Size of cutout	360 x 660 mm
Cooking zone	2 round eco coils <b>SLIDE CONTROL</b> technology
Effective field	2x260 mm
Power	2x3.5 kW
Connected load	2x230 VAC 1L, N, PE 50/60 Hz
Plug	2xCEE 16 (LNPE) or type 23

**MS-I-20 EMP 660****Twin power hob with induction generator box**

Item no.	<b>120726</b>
Dimension of glass	356 x 656 x 6 mm
Size of cutout	360 x 660 mm
Cooking zone	2 round power coils <b>SLIDE CONTROL</b> technology
Effective field	2x300 mm
Power	2x6 kW
Connected load	3x400-440 VAC, 50/60 Hz
Plug	2xCEE 16 (3LNPE) or type 15

**MS-I-20 EMM 660****Twin multifunction hob with induction generator box**

Item no.	<b>120725</b>
Dimension of glass	356 x 656 x 6 mm
Size of cutout	360 x 660 mm
Cooking zone	2 multifunction coils
Effective field	2 x 340 x 360 mm
Power	2x7 kW
Connected load	3x400-440 VAC, 50/60 Hz
Plug	2xCEE 16 (3LNPE) or type 15

**MS-I-20 EMG 800****Twin full-coverage large hob with induction generator box**

Item no.	<b>120728</b>
Dimension of glass	388 x 788 x 6 mm
Size of cutout	392 x 792 mm
Cooking zone	2 full-coverage coils
Effective field	2 x 380 x 380 mm
Power	2x9 kW
Connected load	3x400-440 VAC, 50/60 Hz
Plug	2xCEE 16 (3LNPE) or type 15

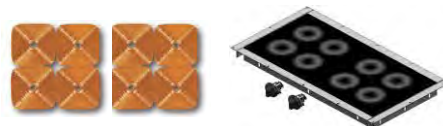
**à la carte hobs with SLIDE CONTROL****MS-I-20 EMS****Twin SLIDE CONTROL hob with induction generator box**

Item no.	<b>120459</b>
Dimension of glass	226 x 388 x 6 mm
Size of cutout	230 x 392 mm
Cooking zone	2 SLC coils <b>SLIDE CONTROL</b> technology
Effective field	2x200 mm
Power	2x3.5 kW
Connected load	2x230 VAC 1L,N,PE 50/60Hz
Plug	2xCEE 16 (LNPE) or type 23

**MS-I-30 EMS****Triple SLIDE CONTROL hob with induction generator box**

Item no.	<b>120461</b>
Dimension of glass	226 x 688 x 6 mm
Size of cutout	230 x 692 mm
Cooking zone	3 SLC coils <b>SLIDE CONTROL</b> technology
Effective field	3x200 mm
Power	3x3.5 kW
Connected load	3x230 VAC 1L,N,PE 50/60Hz
Plug	3xCEE 16 (LNPE) or type 23



1.2. INDUCTION HOBS

**Single hobs**  
MS-I-10  
3x400-440V

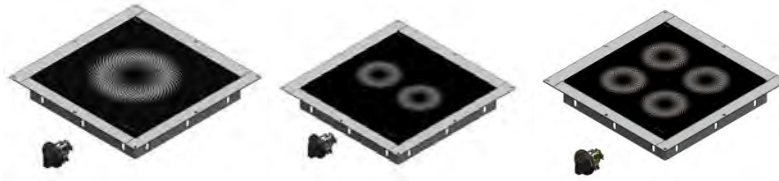

Glass-size:  
388x388mm

Size of cutout:  
stainless steel:  
392x392mm  
Stone:  
394x394mm

Mounting hole frame:  
Ø 8mm

Generator (See item 1.6):  
1x Coil induction  
assemblies 3x400-440V

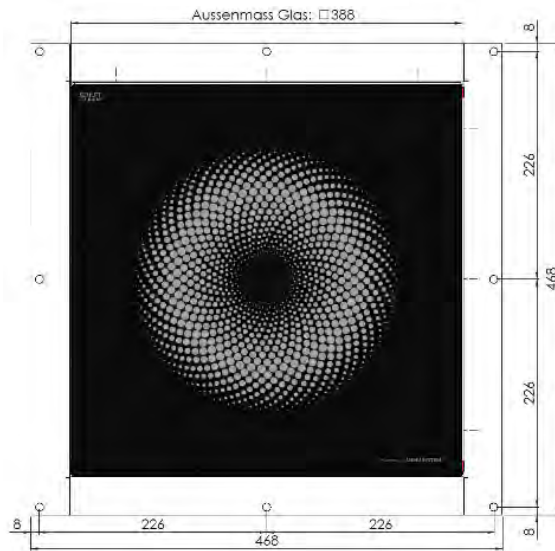

**Twin hob**  
MS-I-20/660  
3x400-440V



Glass-size:  
356x656mm

Size of cutout:  
stainless steel:  
360x660mm  
Stone:  
362x662mm

Mounting hole frame:  
Ø 8mm

Generator (See 1.6):  
2x Coil induction  
assemblies 3x400-440V

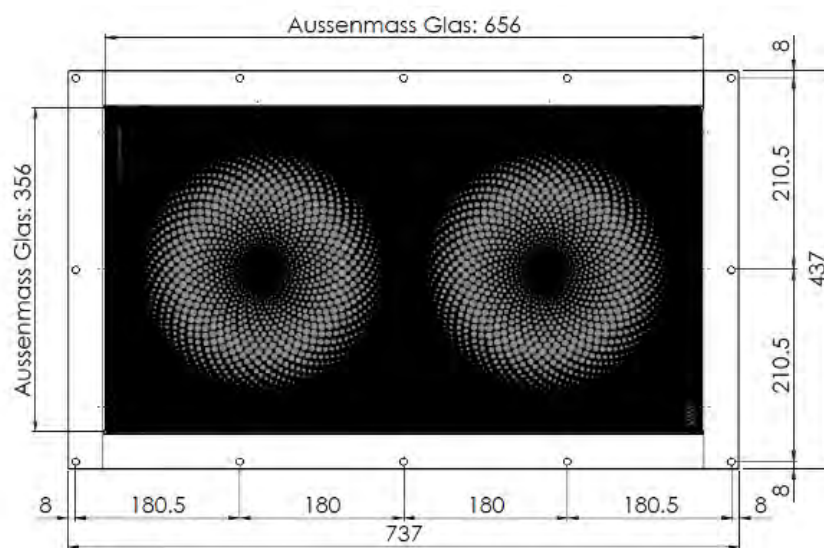

**MENU SYSTEM**

**Twin hob**

MS-I-20/800  
3x400-440V



Glass-size:  
388x788mm

Size of cutout:  
stainless steel:  
392x792mm

Stone:  
392x794mm

Mounting hole frame:  
Ø 8mm

Generator (See 1.6):  
2x Coil induction  
assemblies 3x400-440V

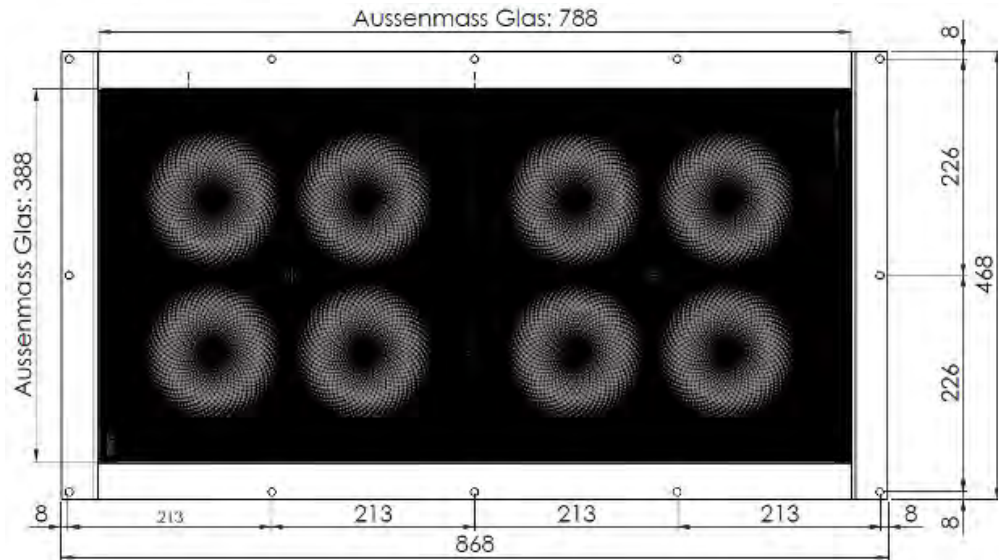

**SLIDECONTROL**

**Twin hob**

MS-I-SLC  
1x230V



Glass-size:  
226x388mm

Size of cutout:  
stainless steel:  
230x392mm

Stone:  
234x396mm

Mounting hole frame:  
Ø 8mm

Generator (See 1.6):  
2x Coil induction  
assemblies 1x230V

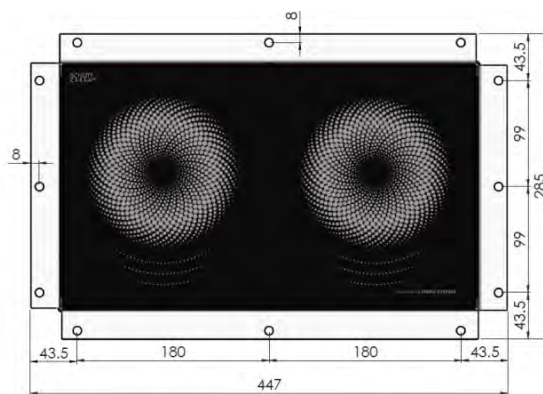

**SLIDECONTROL**

**Triple hob**  
MS-I-SLC  
1x230V



Glass-size:  
226x688mm

Size of cutout:  
stainless steel:  
230x692mm

Stone:  
234x696mm

Mounting hole  
frame:  
Ø 8mm

Generator (See  
1.6):  
3x Coil  
induction  
assemblies  
1x230V

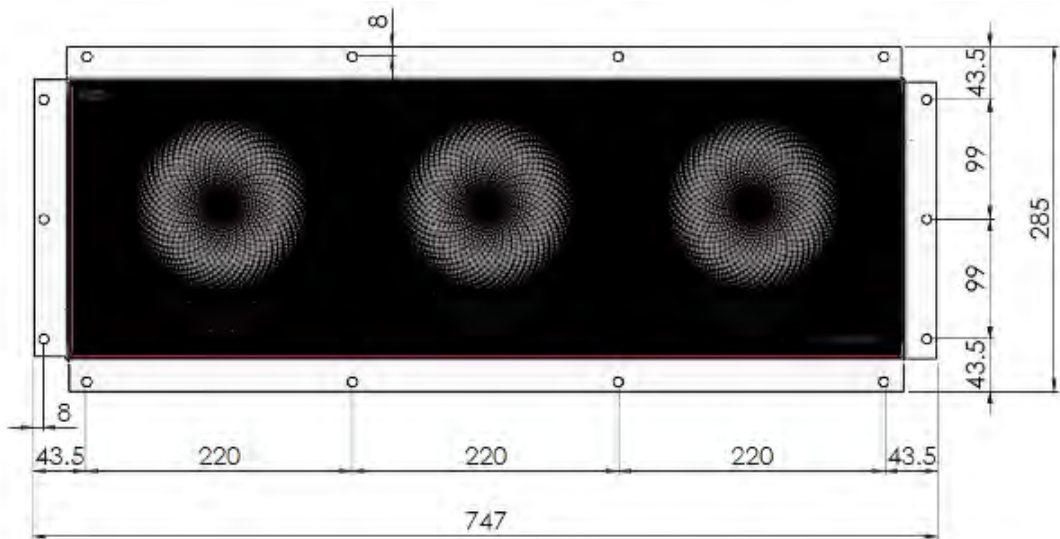

**1.3. WOK**

**Wok 300**  
MS-I-WOK 300  
3x400-440V

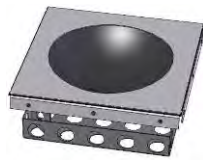

Frame-size:  
388x388mm

Size of cutout:  
stainless steel:  
392x392mm

Stone:  
394x394mm

Mounting hole frame:  
Ø 8mm

Generator (See 1.6):  
1x Coil induction  
assemblies 3x400-440V

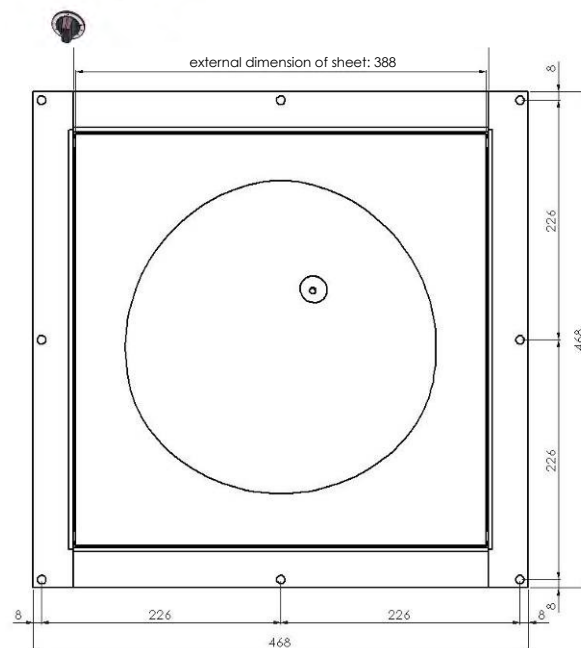

## 1. INDUCTION

---

### 1.1. GENERAL

---

#### Fitting instructions Build in units

The following points must strictly be observed. Failure to do so will result in Menu System AG rejecting all liability and warranty claims.

1. The induction coils must be fitted directly below the 6mm thick Menu System glass ceramic plate (only original Menu System permissible) to ensure maximum performance.
2. No other metal parts may be located closer than 70mm below and 40mm to the side of the induction coil.
3. The induction coil must not be installed such that it is airtight to ensure sufficient air circulation.
4. The maximum ambient temperature for the induction control must not exceed 40°C.
5. The intake air for cooling the induction generator must not exceed a temperature of 30°C and must be clean and free of grease.
6. The exhaust air must be able to escape unhindered to prevent heat build-up.
7. The supply air must be strictly separated from the exhaust air to prevent thermal short circuits.
8. Signal cables must always be laid separately from coil cables to prevent interference.
9. The coil cable for the induction coil must be laid 1m away from magnetic metal parts and must never be looped. The max. length is limited to 5m. Coil cables for different cables must be laid separately.
10. The shielding for the connection cable may only be grounded on the control side. The shielding should be well insulated on the mains side.
11. Only connection cables supplied by Menu System AG may be used.
12. Appliance parts must not be placed on or against combustible materials.
13. The mains plug must not be removed. Direct connection is prohibited!
14. The connection for the mains plug should always be positioned so that it is freely accessible. If this is not possible, a master switch for the appliance must be installed by the customer. In the event of a malfunction the appliance must be switched off completely by unplugging the mains plug or by turning off the master switch.
15. The induction module must be accessible at all times for servicing.
16. The ground conductor for the shielding and the mounting frame must always be sufficiently grounded.
17. Coils, the display and potentiometers must be installed in such a way that prevents contact with the electrical connections. A removable service cover must be present. All metal housing parts must be sufficiently earthed (protection class I).
18. Unauthorised conversions or modifications are prohibited. Menu System AG accepts no liability in such cases.

#### Minimum distances (Measured from glass cutout)

- Hob to hob 85mm
- Hobs to leading edge cover 50mm + Xmm
- Hobs to trailing edge cover 50mm
- Hob to lateral cover 50mm

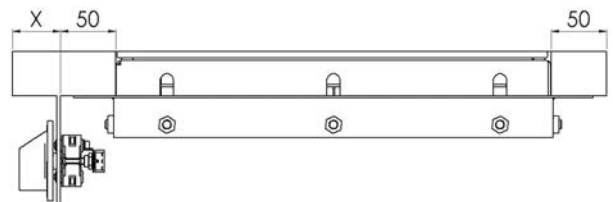

#### 1.4. CUTOUT CONTROL

---

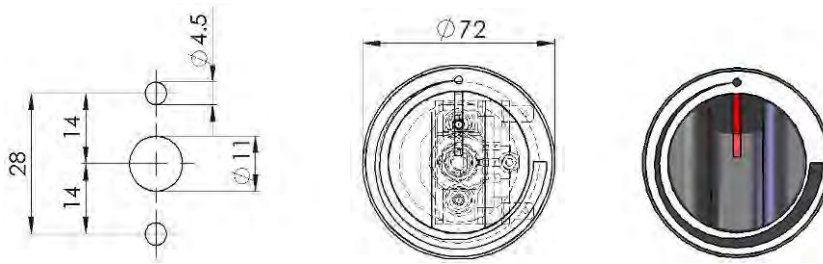

#### 1.5. SILICONE JOINT

---

The glass ceramic is glued into the surface of the cooking suite with silicone Pactan 7076 anthracite ADR. Ensure that the glass is installed flush with the cover surface, otherwise the glass may be damaged as a result of improper handling.

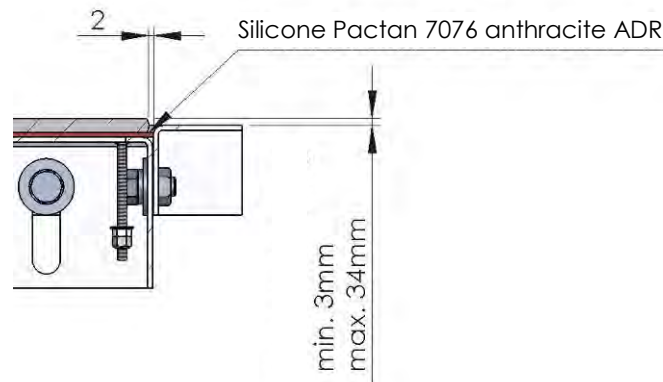

#### 1.6. INDUCTION GENERATORS

---

One coil induction assembly is required for each induction coil. This can either be positioned in an induction generator cabinet or a built-in module. Both must be fitted such that sufficient air can be sucked in and the exhaust air is dissipated (risk of heat build-up). See chapter 1.1, point 3-7.

It is both important and essential that you ensure the induction modules are installed in the space intended for them and that the coil, display and connection cables marked with numbers are connected to the corresponding induction module.

The built-in modules and induction feet are not splash-water resistant. Therefore you should not use any running water when cleaning, and avoid direct contact with water vapour.