

User Manual

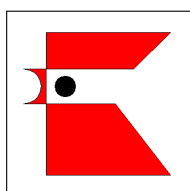

CE

Rotor Hot Display
RHD



ubert[®]

1 Contents

1	Contents	3
2	Product information	4
2.1	<i>Dimensions (mm)</i>	4
2.2	<i>Technical Data</i>	5
2.3	<i>Accessories</i>	6
3	Installation.....	7
3.1	<i>Unloading</i>	7
3.2	<i>Installation</i>	7
3.3	<i>Electrical connection</i>	7
3.4	<i>First Function check</i>	8
4	Operation	9
4.1	<i>Description of the operation display</i>	9
4.2	<i>The Warmingprocess</i>	9
5	Maintenance	10
5.1	<i>Cleaning and care</i>	10
5.2	<i>Troubleshooting</i>	11
5.3	<i>Wiring Diagram</i>	13
5.4	<i>Spare Parts</i>	14
5.5	<i>Declaration Of Conformity</i>	16

2 Product information

2.1 Dimensions (mm)

RHD

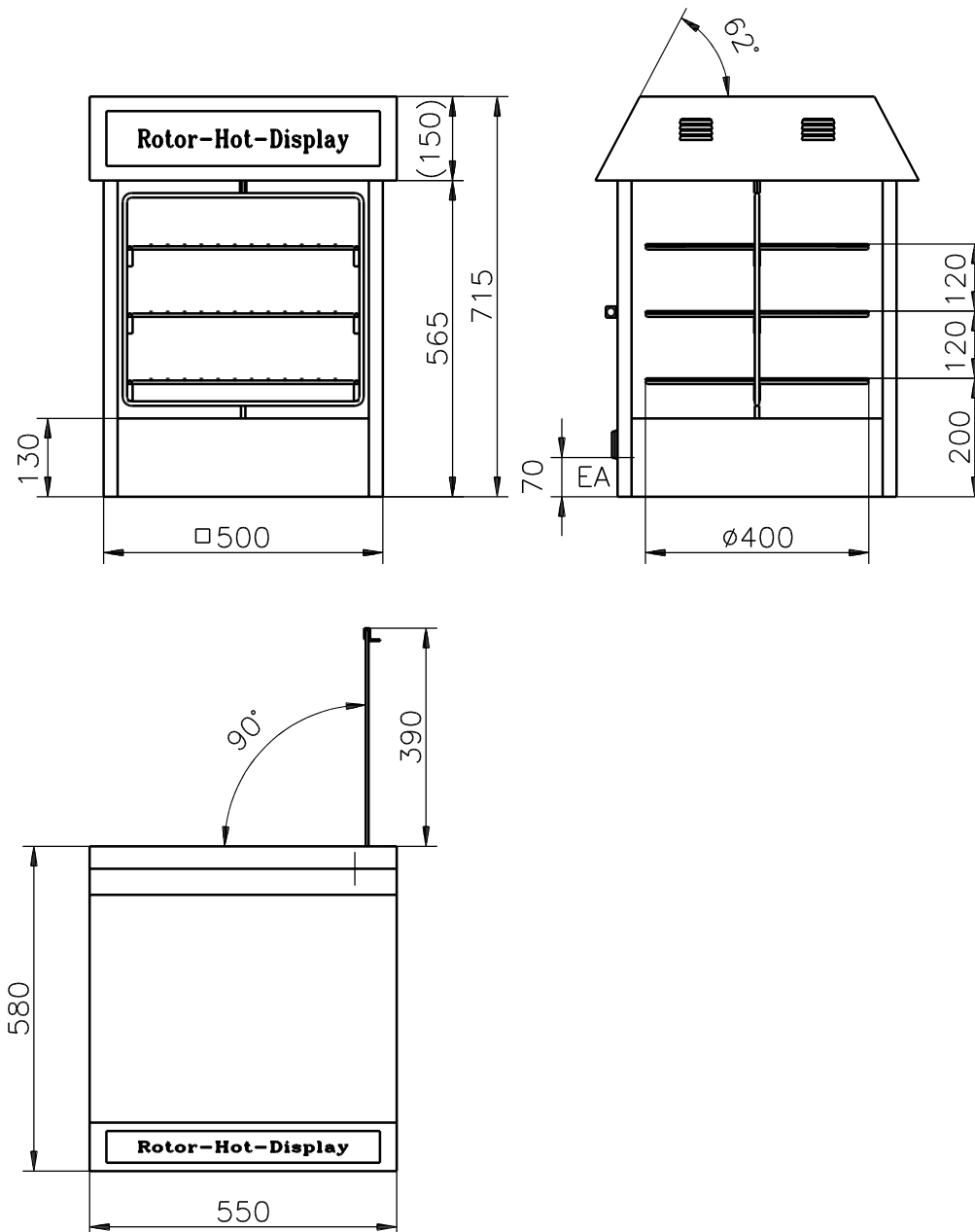

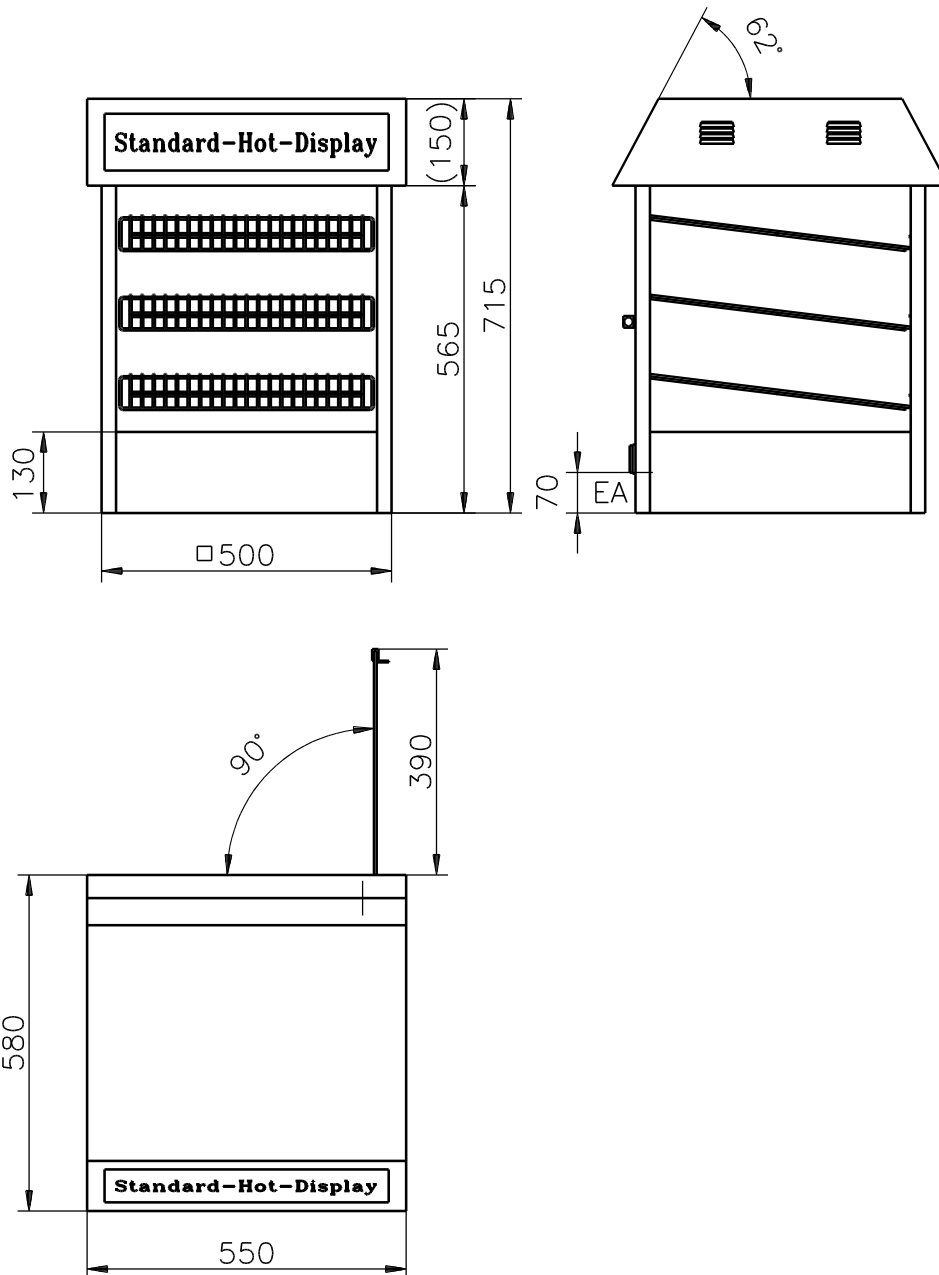
SHD**2.2 Technical Data**

Weight: 30 kg

Power: 1.2 kW, 120 V AC / 60 Hz / 1 Ph / N

Noise Emission < 70 dBA

2.3 Accessories

Optional accessories:

- fixed shelves Part No.: 409005

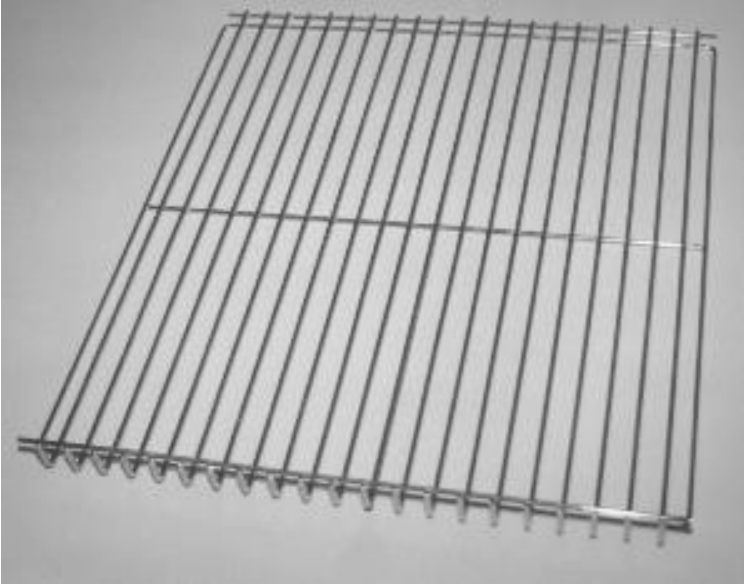

- rotating shelves Part No.: 409002



3 Installation

This equipment was carefully inspected at the factory; nevertheless all shipping containers should be examined for damage before and during unloading.

Note ! A claim must be made with the delivery carrier at once!



3.1 Unloading

Remove carefully all packing and padding material around the Rotor Hot Display and prepare it for installation. Take out all removable parts and examine their completeness according to the freight papers.

3.2 Installation

Note the following installation-instructions:

- Place the Rotor Hot Display in a horizontal position. If necessary, use a spirit level. The adjustable legs below the unit enable an appropriate alignment.
- All air inlet- and outlet-openings should have a minimum distance of 10 cm (4 inch) to the next wall.
- The unit should always be easily accessible for operation, cleaning and maintenance.
- Place the unit easily visible for your working personal so that they can observe the warming process.
- The surrounding area should be easily to clean after installation of the Rotor Hot Display.

3.3 Electrical connection

Note! Note that also after installation and electrical connection the plug must be accessible. If this is not possible due to structural reasons, or if the unit is connected permanently, the power supply needs to have an interlock switch.



Note! During any servicing, take care that the unit is disconnected from the mains! Not paying attention may result in injury!



Please learn the electrical and technical data of your unit from the nameplate.

- The unit is ready for plug-in.
- For power supply a shockproof socket is necessary.
- Make sure the supply cable is protected separately with 10 Amps.

Note!

After finishing any installationwork, maintenance or repair check whether the ground wires are connected properly to the casing.



3.4 First Function check

Before the Rotor Hot Display is used for the first time, the interior and all removable parts should be cleaned properly with a detergent.

Note ! Do not use any combustible liquid for cleaning. Don't clean with waterjet, steamjet or other high pressure cleaning systems. You will find detailed instructions in the section cleaning and care.



By this first cleaning you will minimize annoying smells and smoke on the first usage. It is the best way to work with your new Rotor Hot Display in a secure manner.

The following checklist is for a first function examination:

- Connect the unit to the field.
- After pushing the lighting switch, both cavity lamps as well as the Slide-Board on the customer side will illuminate.
- After pushing the motor-switch, the shelves will start to rotate.
- Turn the thermostat knob to start warming of the Rotor Hot Display.

4 Operation

To get an even result on the warming process, the Rotor Hot Display should be preheated after longer times of standstill.

4.1 Description of the operation display

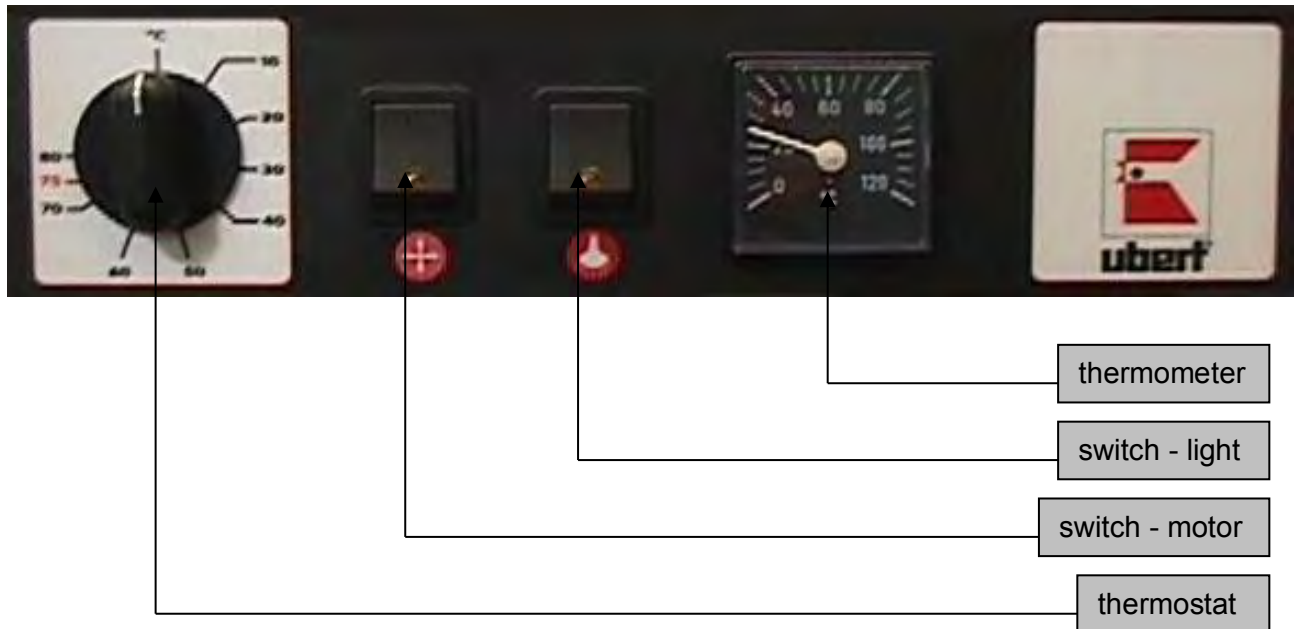

- **Temperature**
By turning the thermostat knob the desired temperature will be adjusted.
- **Rotation**
By pushing the motorswitch the rotation of the shelves will start.
- **Illumination**
By pushing the lightingswitch both cavity lamps as well as the Slide-Board on the customer side will illuminate.
- **Temperature control**
The thermometer enables the user to observe the temperature inside the Rotor Hot Display

4.2 The Warmingprocess

Optimised warming is obtained by the following features:

- The holed bottom plate ensures a balanced distribution of heat inside the cavity.
- By filling the drawer with water an even humidity of the air inside the Rotor Hot Display is achieved and drying of the products will be avoided.
- To enable easily charging and discharging the rotation of the shelves is interrupted while the door is opened.

5 Maintenance

Here are some important notices on maintenance and care, troubleshooting and service of your Rotor Hot Display.

5.1 *Cleaning and care*

The unit has to be cleaned daily.

Note ! Before you start cleaning, disconnect the unit from the mains.



5.1.1 Special notes

- remove shelves, rack, bottomplate and drawer to clean them separately.
 - Shelves:
Raise the shelves to separate them from the rack and remove them from the unit.
 - Rack:
By slightly pressing the upper horizontal bows downwards, the hexagonal pivot comes out of the liner and the rack now can be removed from the unit.
- Bottomplate:
Lift up the bottomplate on the operatorside and remove it.
- Drawer:
Pull the drawer out of the unit on the operator side.

5.1.2 General notes

- Use only food proofed detergents for cleaning.
- After using detergents or similar materials all parts should be washed with clear water and afterwards be dried. All residues of detergent must be removed.
- In general, the following principals must be noted to keep a stainless steel unit like this in good condition:
 - Clean stainless steel surfaces
 - good ventilated stainless steel surfaces
 - Avoid contact of the stainless steel surfaces to any rusty parts.

Important ! Do not use bleaching agents or detergents containing chlorine for cleaning.



5.1.3 Detergents and care materials

For easy and fast cleaning our delivery program includes:

- Grillcleaner
Put on the grillcleaner and let it take effect for app. 10 - 15 minutes. Afterwards wash all parts properly with clear water.
- Care material for stainless steel
Spray it from a distance of app. 25 cm (10 inch) on the surface and wipe it afterward with a soft and dry cloth. For smaller areas, spray it directly on the cloth and wipe the surface.
This guarantees easy cleaning and brilliant shine.

5.2 Troubleshooting

If the performance of your oven is not satisfactory, we give you a short checklist for a first examination realized by yourself. Please check all items before you call:

a) your authorized service company (please ask your dealer for address, phone- and faxnumber)

or

b) directly the company UBERT GASTROTECHNIK GmbH
Werk II Gewerbegebiet Nord
Vennekenweg 17
46348 Raesfeld
Germany
Tel.:(49) 02865 / 602-226
Service-Tel.:0172 / 2 82 86 31
Fax:(49) 02865 / 602-102 (or -103)

Note ! Only these two companies are allowed to carry out service work and replacement of defect parts. If you do not observe this note or in case of manipulation of a third party any claims for guarantee will become invalid!



5.2.1 Troubleshooting

Error	Possible Reason	Remedy
Unit does not work	a. Power supply incorrect b. Main fuse defective	unit properly plugged? Examine fuse! call for local electrician
Heaters do not work	a. Thermostat not set properly b. Heatingelement defective	Adjust Thermostat Call for service
Motor does not work	a. Door opened b. Gearmotor defective	Close the door Call for service
Products dry	no water in drawer	Refill water to the drawer
Cavitylamps don not illuminate	a.Lamp not switched on b. Lamp defective	Switch on lamp Exchange lamp
Diaboard does not illuminate	a. Lamp not switched on b. Bulb defective	Switch on lamp exchange bulb

5.2.2 Exchange of cavitylamp

Follow the description below to exchange a cavitylamp:

- Disconnect the unit from the mains and let it cool down completely.
- Remove all interior parts.
- Lift the protective glass from the light.
- Remove the defective lamp carefully by screwing it counterclockwise.
- Screw the new lamp carefully into the socket. Avoid touching the lamp directly with your fingers, because all residues on the lampglass reduce the lifespan of the lamp.
- Apply the protective glass again.

5.2.3 Exchange of bulb

Follow the description below to exchange a fluorescent lamp:

- Disconnect the unit from the mains and let it cool down completely.
- Detach the 4 screws inside the hood and remove it..
- By a quarterturn of the bulb it gets loose and can then be removed.
- Replace the faulty part and apply all parts again in reverse sequence.



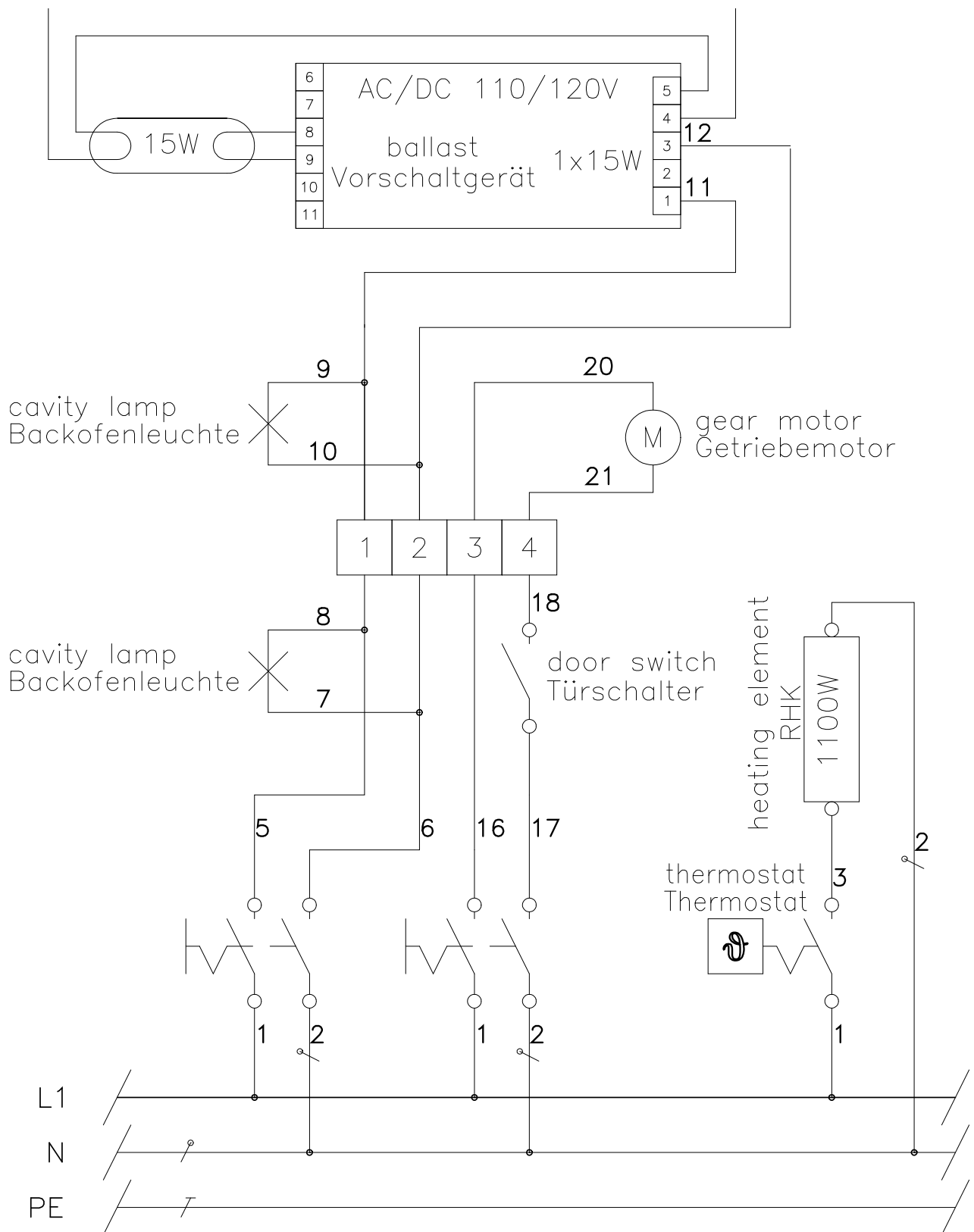





5.3 Wiring Diagram

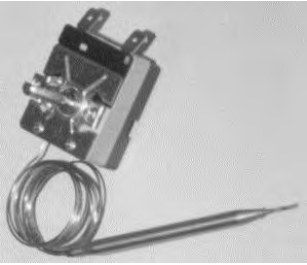
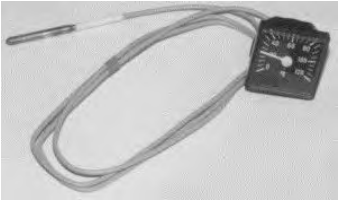
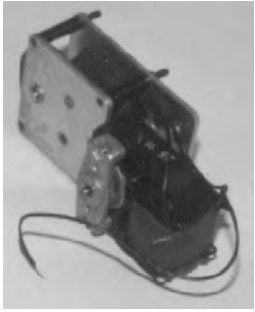
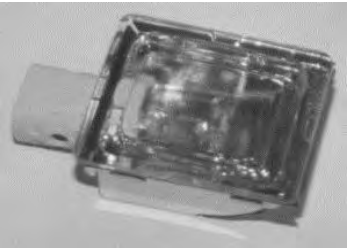



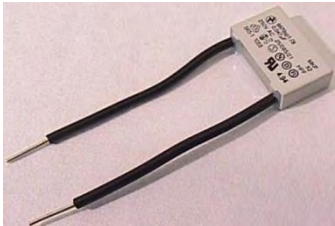

5.4 Spare Parts

Important! Faulty parts may only be exchanged against original spare parts of Ubert Gastrotechnik GmbH; the exchange may only be made by their service personal or the personal of an authorized service company. If this precondition is not fulfilled or any third party manipulates the unit, each claim for guarantee is forfeited!

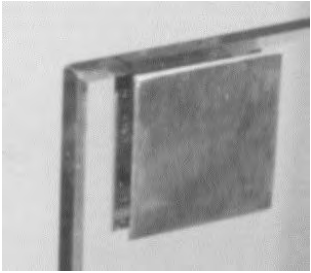
5.4.1 Spare Parts List

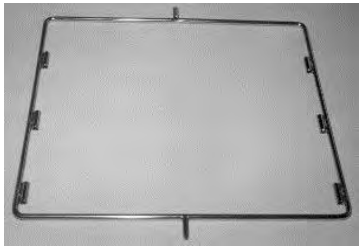
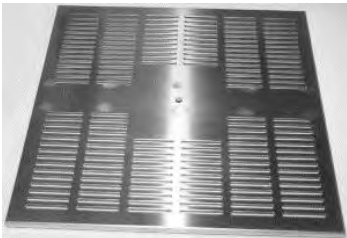
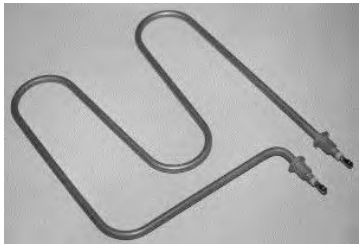
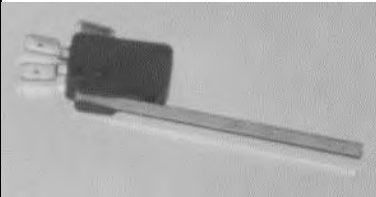
<p>Thermostat 342209</p> 	<p>Thermometer 342907</p> 	<p>Gearboxmotor 380120</p> 
<p>Cavityillumination 340711</p> 	<p>Lamp 340710</p> 	<p>Ballast 340125</p> 
<p>Flourescent lamp</p> 	<p>Bulbsocket 340103</p> 	<p>Starter 340101</p> 
<p>Starterfassung 340117</p> 	<p>Entstörkondensator 340115</p> 	<p>Doormagnet 370503</p> 

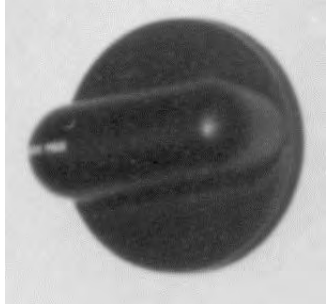
<p>Counterplate 121544</p> 	<p>Doorhinge (top + bottom) 370214</p> 	<p>Doorhandle 370113</p> 
<p>grill rack right assy 121586</p> 	<p>grill rack left assy 121587</p> 	<p>Rack 409001</p> 
<p>Drawer 121543</p> 	<p>Bottomplate 121536</p> 	<p>Heatingelement 343125</p> 
<p>Terminalblock 121546</p> 	<p>Doorswitch 341151</p> 	<p>plug 3431301</p> 
<p>Switch 341108</p> 	<p>Leg (adjustable) 361105</p> 	<p>Knob 361311</p> 

5.5 Declaration Of Conformity

UBERT GASTROTECHNIK GMBH
 Gewerbegebiet Ost + Nord
 D-46348 Raesfeld

Telefon: +49 (0) 28 65 / 602-0
 Fax: +49 (0) 28 65 / 602-102
 Internet: www.ubert.com
 e-mail: info@ubert.com



CE KONFORMITÄTSERKLÄRUNG DECLARATION OF CONFORMITY CERTIFICAT DE CONFORMITÉ

Hereby we declare that the unit noted below, on the basis of its concept, design and version, meets all basic health and safety requirements of the applicable EC-directive. This declaration is no longer effective in case this machine has been modified without our approval.

Product designation: Rotor Hot Display

Model: RHD

EC-directives followed:
 EC-directive for machines **2006/42/EG**

Harmonized European Standards:
 EN 55014 Electromagnetic compatibility – Requirements for household appliances,

Applied national standards and technical specifications:
 BGR111 directions for safety and health protection regarding kitchen work

This declaration does not include any assurance of characteristics.
 The safety references enclosed with the product documentation have to be followed.
 By internal actions it is guaranteed, that all serial units meet the demands of the corresponding EC directive and the applied standards.
 The signers are entitled to compose the technical documents.

Raesfeld, 01.01.10
 UBERT GASTROTECHNIK GMBH

 Christoph Stephan
 Vice President, R&D / Engineering

Raesfeld, 01.01.10
 UBERT GASTROTECHNIK GMBH

 Michael Peters
 Service - Manager

Manufactured by: UBERT GASTROTECHNIK GMBH
 Gewerbegebiet Ost + Nord
 D-46348 Raesfeld