



# **Brukerveiledning**



## **BOXER SERIES MARLIN SERIES FALCON SERIES POLAR SERIES**

### Importør – Myhrvold-Gruppen

Adresse Frysjeveien 33b  
0884 Oslo

P.O. Box 24 Kjelsås  
0411 Oslo

Telefon +47 2270 1000

E-mail [post@myhrvold.no](mailto:post@myhrvold.no)  
Internet <http://www.myhrvold.no>



Versie 11.10 DIG.EN

Versie 11.10 DIG.EN

*This manual is for the BOXER/ MARLIN/ FALCON/ POLAR series. The general instructions apply to the models in this category. Henkelman B.V. cannot be held responsible for any damage caused by deviating machine specifications.*

*This manual has been established with care. Henkelman B.V. does not accept liability for errors in this manual and/or consequences of misinterpretation of the instructions.*

*Henkelman B.V. is not liable for damages and/or problems that arise from using spare parts that are not supplied by Henkelman B.V.*

*Henkelman B.V. reserves the right to change specifications and/or spare parts without prior notification.*

*All rights reserved. No part of this publication may be reproduced by photocopy, printing or in any other way without prior consent from Henkelman B.V.*

## **LIABILITY**

---

1. We exclude all liability as far as it is not provided for by law.
2. Our liability shall never exceed the total amount of the order in question.
3. Barring the generally applicable legal rules of public order and good faith we are not liable to pay for any damage of any sort whatsoever, directly or indirectly, including business losses, to movable or immovable property, or to persons, either at the opposing party as at third parties.
4. We are in any case not liable for damages arising from or cause by the use of the product supplied or by the unsuitability of it for the goal for which the other party purchased it.

## **WARRANTY**

---

Subject to the following limitations, the warranty period for products supplied by Henkelman is at least 12 months, as of the date indicated on the purchase document. This warranty is limited to manufacturing and machining defects and does therefore not cover breakdowns involving any part of the product that is exposed to any form of wear and tear. Normal wear and tear that can be expected with the use of this product is therefore hereby excluded.

1. Henkelman's responsibility is limited to replacing parts found to be defective; we shall not acknowledge claims for any other kind of damage or costs.
2. The warranty does not apply if the defect is the result of incorrect or negligent use, or maintenance that is contrary to the instructions given in this manual.
3. The warranty lapses if repairs or modifications on the product have been carried out by third parties.
4. Defects due to damage or accidents deriving from outside factors are excluded from the warranty.
5. If we replace parts in compliance with the obligations of this warranty then the replaced parts become our property.
6. If the other party does not, not sufficiently, or not in an acceptable period of time, fulfils the obligations to the agreement between the parties, we are not obliged to provide this warranty as long as the situation is occurring.

The stipulations of the warranty and liability are part of the general terms and conditions of sales, which we can send to you if requested.

## CONTENT USER MANUAL

INTRODUCTION / LIABILITY / GUARANTEE .....	2
CONTENTS INSTRUCTION MANUAL .....	3
MACHINE REGISTRATION .....	4
IMPORTANT FOR INSTALLATION – READ THIS FIRST!!!! .....	5
IMPORTANT FOR USE – READ THIS FIRST!!!! .....	7
WARNING LABELS .....	8
IMPORTANT MACHINE PARTS .....	9
<b>START OG BRUK AV PRODUKTET</b> .....	<b>11</b>
<i>ON/OFF (AV/PÅ) BRYTER + NØDBRYTER</i> .....	11
<i>StandBy funksjon</i> .....	11
<i>Start maskinen</i> .....	11
<i>Standard bruk. Steg for steg</i> .....	12
<b>MASKINENS BETJENINGSPANEL</b> .....	<b>13</b>
<i>Betjeningspanel</i> .....	14
<i>Forklaring av punkter på betjeningspanel</i> .....	15
<i>Instillinger av programsykluser (manuel)</i> .....	16
<i>Instillinger av programsykluser (automatisk)</i> .....	17
<i>Programmodus/Andre modus</i> .....	19
<i>Brogramsykluser</i> .....	19
<b>PROGRAMMERING</b> .....	<b>20</b>
<i>Manual programmering</i> .....	20
<i>Automatic programmering</i> .....	21
<b>MACHINE MAINTENANCE</b> .....	<b>23</b>
<i>General</i> .....	23
<i>Important before and during maintenance</i> .....	23
<i>Standard maintenance schedule</i> .....	24
<i>Vacuum pump maintenance</i> .....	24
<i>Seal system maintenance</i> .....	27
<i>Silicone holder and lid gasket maintenance</i> .....	29
<i>List of maintenance parts</i> .....	30
<b>TECHNICAL SPECIFICATIONS</b> .....	<b>32</b>
<b>ELECTRICAL DIAGRAMS</b> .....	<b>33</b>
<b>ERRORS CODES</b> .....	<b>36</b>
<b>PNEUMATIC DIAGRAMS</b> .....	<b>37</b>
<b>PROBLEM SOLVING</b> .....	<b>38</b>
<b>FACTORY SETTINGS CONTROL</b> .....	<b>40</b>
<b>SPECIAL APPLICATIONS</b> .....	<b>41</b>
<i>Machine with gas flush system</i> .....	41
<i>Packaging liquid products</i> .....	41
<i>External vacuuming of food containers</i> .....	42
<b>EEC DECLARATION OF CONFIRMITY</b> .....	<b>43</b>
<b>MAINTENANCE SCHEDULE / NOTES</b> .....	<b>44</b>
<b>REMOVAL FRONT PANEL</b> .....	<b>45</b>



**PRIOR TO STARTING TO USE THE MACHINE,  
MACHINE REGISTRATION TO BE COMPLETED BY THE USER**

Register the machine using the following data. This information is necessary if the supplier or Henkelman BV is contacted concerning questions or references about the specific machine.

*DATA ON MACHINE TAG*

Relevant data for answering questions can be found on the machine tag. The machine tag is located at the rear of the machine. Note down the following data:

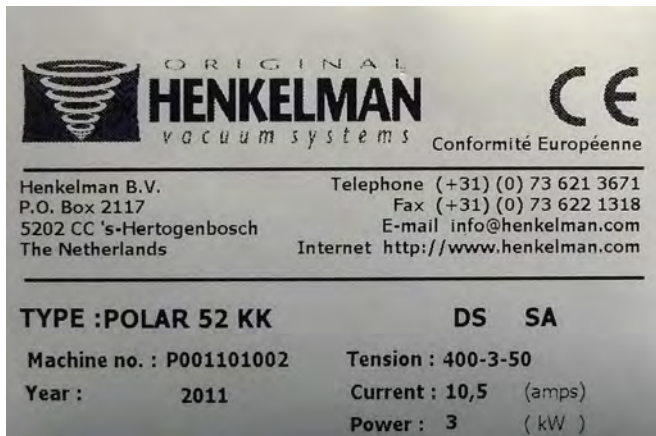

1. MACHINE TYPE

2. MACHINE NUMBER (MACHINE NO.)

3. VOLTAGE (TENSION)

*CONTROL PANEL DATA*

When starting the machine, two codes appear on the display consecutively, before the control switches to user mode. The first code indicates the software version of the control software and the second code indicates the active options. Please write down the codes below:



4. CODE 1



5. CODE 2



---

**IMPORTANT FOR INSTALLATION!!! READ THIS FIRST!!!**

---

*GENERAL*

- First read this manual carefully before the machine is put into operation.
- This manual contains relevant information and instructions for starting up, maintenance and applications.
- If problems arise with the machine that could have been avoided by referring to this manual then the guarantee expires.
- Henkelman BV wishes the customer lots of pleasure for an extended period from the purchase of the machine. If there are any problems or questions then the customer can always approach the supplier or Henkelman BV.

*ENVIRONMENT*

- The machine must be moved or transported in an upright position. The machine may NOT be tilted as this can cause damage to the pump.
- Place the machine on a flat, level floor. This is essential for problem free operation of the machine.
- Enough space must be left around the machine for good ventilation. The space must be at least 5 centimetres.
- The ambient temperature in which the machine is operated must be between 10 °C and 30 °C. When operating the machine in other ambient temperatures the user must contact the supplier or Henkelman BV for advice.
- NEVER place the machine directly next to a heat source or a steaming device (for example a combi-steamer, dishwasher or stove)

*POWER / EARTH*

- Check that the voltage stated on the machine tag is the same as the mains voltage.
- Check the direction in which the pump is running when the machine is connected to a three phase power source.
- Always connect the machine correctly to an earthed socket to avoid danger for fire or electrical shocks (earth connection is green/yellow).
- The power cable must always be free and nothing may be placed on it.
- Replace the power cable immediately if damaged.
- Always disconnect the power if there are problems with the machine or during maintenance, prior to starting work on the machine.
- If the machine is stationary for long periods then the power should always be disconnected.

## VACUUM PUMP

- Check before starting the machine if there is oil in the pump (see page 23). NEVER start the machine without oil in the pump.
- Use the right type of oil for the pump (see page 24).
- After moving and/or transporting the machine, always first check the oil level before re-starting operation.
- When starting the machine for the first time or after a lengthy idle period, first run the conditioning program before operating the machine (see page 22).
- Always change the oil before a long period of inactivity of the machine and make sure the pump is clean and free of moisture.

## CONNECTING THE GAS FLUSH SYSTEM (if applicable)

- NEVER use flammable gasses or gas mixtures containing too much oxygen. There is a danger of explosion when using the aforementioned gasses. Accidents and/or damage caused by using abovementioned gasses void all liability on the part of Henkelman BV as well as the guarantee.
- The gas bottles must always be correctly secured. If the gas flush function and/or the machine is not in use then the main cock of the gas bottle must always be closed.
- The pressure of the pressure reducing valve on the gas bottle may NEVER be set to more than 1 atmosphere/ATO. A higher pressure may damage the machine.
- The diameter of the hose nipple connector for the gas bottle is 6 mm (BOXER and MARLIN 42/42 XL), 13 mm (POLAR 2-85 and 2-95), and 8 mm for other machines. The connector is at the rear of the machine.

*For more information about the use of gas bottles, please consult an authorised gas supplier*

## CONNECTING COMPRESSED AIR FOR EXTERNAL SEALING PRESSURE (if applicable)

- The pressure from the compressor may NEVER be set to more than 1 atmosphere/ATO. A higher pressure may damage the machine.
- Only dry compressed air may be used for the external seal pressure.
- The diameter of the hose nipple connector the compressor is 6 mm (rear machine)

*For more information about the use of compressed air, please consult an authorised gas supplier*



---

**IMPORTANT FOR OPERATION !!! READ THIS FIRST !!!**

---

*GENERAL*

- Never pack products that can be damaged during or after vacuum packaging. Live oats may never be vacuumed.
- Refer to this manual if in doubt as to the operation and/or functioning of the machine. If the manual does not offer a solution consult the supplier or Henkelman BV.
- The guarantee and/or liability expires if damage is caused by repairs and/or changes made by you. In the case of malfunctions contact the supplier or Henkelman BV.
- In the case of malfunctions always stop the machine and remove the power cable from the wall socket.

*GENERAL MAINTENANCE*

- It is essential that the machine is serviced regularly to guarantee operation and to keep the machine in optimal condition. The maintenance schedule is clearly defined on page 22. The guarantee automatically expires due to overdue or sloppy maintenance.
- Always remove the power cable from the wall socket for maintenance work; the machine must be completely disconnected.
- If there are doubts about the maintenance activities or if the machine fails to work correctly always contact the supplier or Henkelman BV.

*TRANSPARENT LID (if applicable)*

- Never locate the machine near a heat source. This can cause damage to the lid (cracks).
- Never place hot, sharp, or heavy objects on the lid. These can cause damage to the lid (cracks) in the long run.
- Always clean the lid with solvent-free cleaning agents. Solvents can damage the lid.
- Check at least once a week if there are cracks in the lid. If cracks are visible in the lid then the machine must IMMEDIATELY be turned off and not used again until the lid has been replaced. Continuing to work with a cracked lid can cause the lid to implode. All guarantees and/or liability expire in the case of accidents and/or damage caused by working with a cracked lid.
- Replace the transparent lid every 4 years as a precautionary measure as a standard maintenance interval.

## VACUUM PUMP

- Regularly check the level and quality of the oil in the pump. If there is too little oil or the quality of the oil is bad (turbid), replace or top up the oil before operating the machine (see page 23). Let the pump conditioning program run at least one full cycle before replacing the oil (see page 22).
- Use the right type of oil for the pump when replacing or filling up (see page 24).
- Use the conditioning program at least once a week to enhance correct and long-lasting pump operation (see page 22).

## USE OF GAS FLUSH SYSTEM (if applicable)

- NEVER use flammable gasses or gas mixtures containing too much oxygen. Use thereof can cause risk of explosions. Accidents and/or damage caused by using abovementioned gasses voids all liability on the part of Henkelman BV as well as the guarantee.
- The gas bottles must always be correctly secured. If the gassing function and/or the machine is not in use then the main cock of the gas bottle must always be closed.
- The pressure of the pressure reducing valve on the gas bottle may NEVER be set to more than 1 atmosphere/ATO. A higher pressure may damage the machine.

For more information about the use of gas bottles, consult an authorised gas supplier



## WARNING SIGNS ON THE MACHINE!!!



- ONLY use the prescribed power supply voltage.
- Insert the plug firmly into the mains wall socket.
- Always connect the machine to an earthed wall socket
- Always remove the plug during maintenance or when the machine is not in use for extended periods.



- NEVER use flammable gasses or gas mixtures containing too much oxygen. Use thereof can cause risk of explosions
- Accidents and/or damage caused by using abovementioned gasses void(s) all liability on the part of Henkelman BV as well as the guarantee.

## IMPORTANT MACHINE PARTS



FALCON SERIES

BOXER SERIES

MARLIN SERIES



Side view BOXER machines

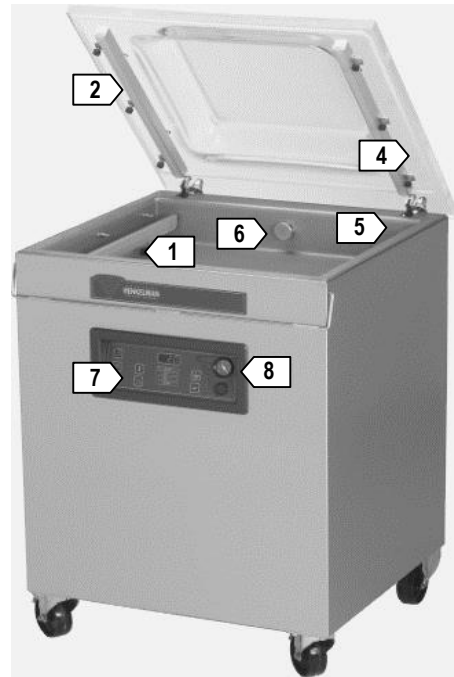

Rear view MARLIN machines

Vacuum chamber

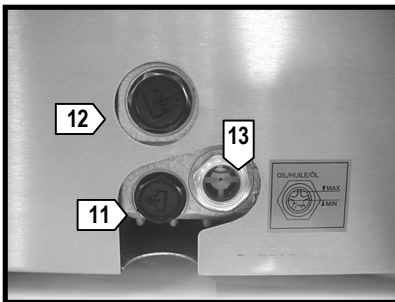
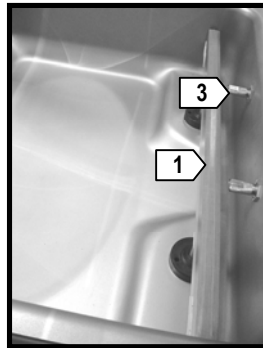

Rear view BOXER machines

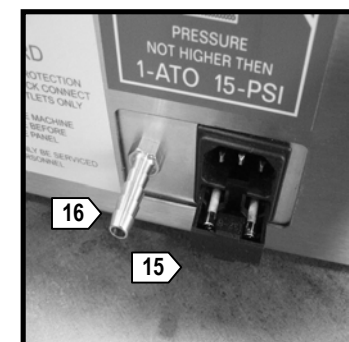
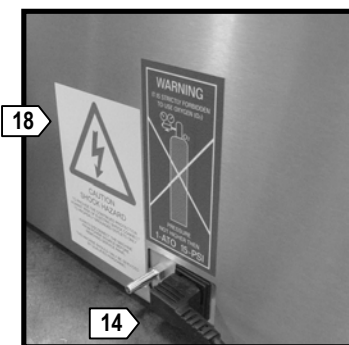
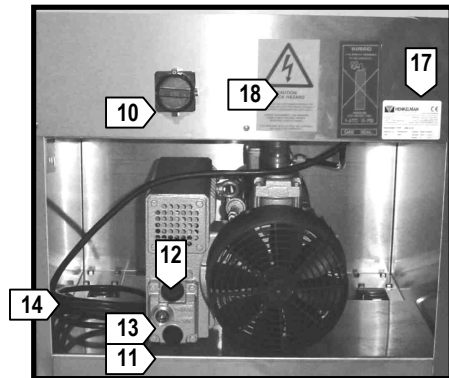

1. Sealing bar(s) in vacuum chamber
2. Silicone holder(s)
3. Gas flush nozzles (if applicable)
4. Lid rubber in lid for hermetic seal
5. Gas springs for opening lid after machine cycle
6. Vacuum / Ventilation opening
7. Control panel
8. Vacuum pressure meter
9. ON/OFF Switch
10. Master switch (only MARLIN series)
11. Oil drain plug
12. Oil fill plug
13. Oil inspection window
14. Power cable
15. Fuse holder with fuse
16. Gas bottle connector (if applicable) caution max 1 Bar
17. Machine tag
18. Warning stickers

Appearance of parts and machines can deviate from illustrations

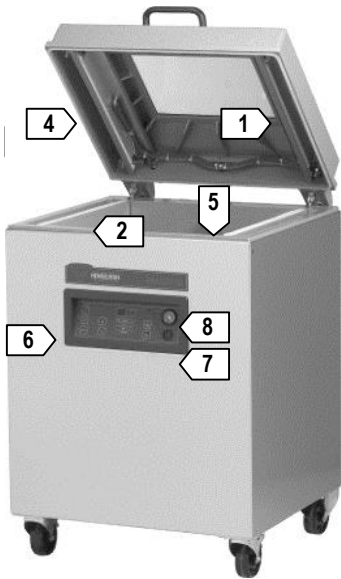

Rear view FALCON series and POLAR single chamber models

Inside lid POLAR series

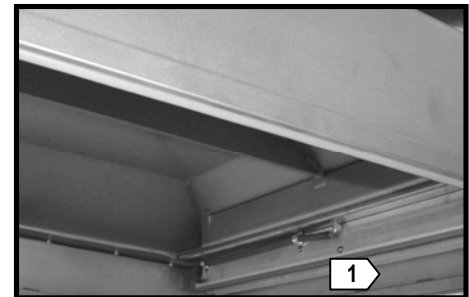
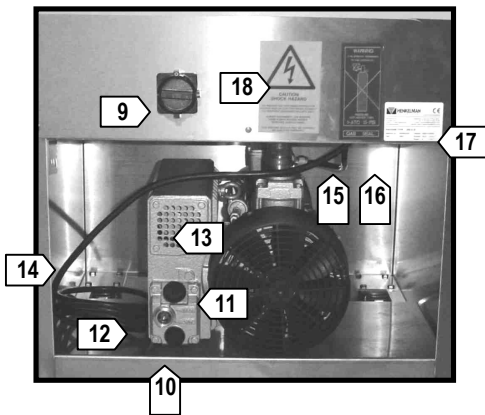

Side POLAR double chambers after opening side of housing

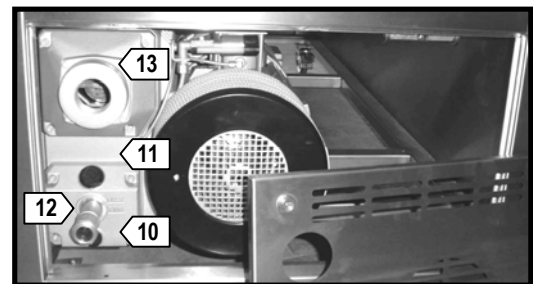

Rear view POLAR double chambers

1. Sealing bar(s) in lids
2. Silicone holder(s) on holders in vacuum chamber
3. Gas flush nozzles mounted on silicone holders (if applicable)
4. Lid rubber in lid for hermetic seal
5. Vacuum / Decompression / Suction pipe
6. Control panel
7. ON/OFF switch
8. Vacuum pressure meter
9. Master switch
10. Oil drain plug/elbow
11. Oil filler cap
12. Oil inspection window
13. Oil spray filter housing
14. Power cable
15. Gas bottle connector (if applicable) caution max 1 Bar
16. Seal pressure connector (if applicable) caution max 1 Bar
17. Machine tag
18. Warning stickers

Appearance of parts and machines can deviate from illustrations

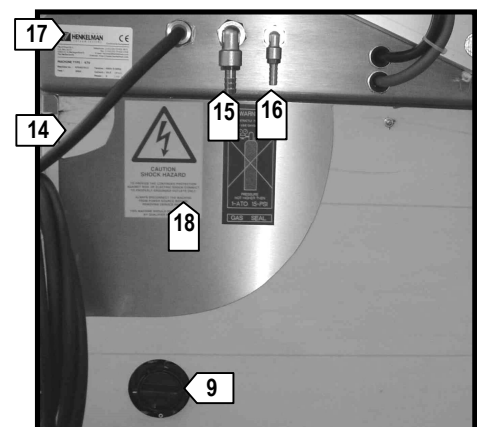

## START OG BRUK AV MASKINEN



AV/PÅ bryter



Hovedbryter

AV/PÅ bryteren brukes til å skru på før bruk og av etter bruk.

**ADVARSEL-** AV/PÅ bryteren skrur ikke av all spenning på maskinen. På BOXER serien og alle andre 1fas modeller er det nødvendig å trekke ut støpselet før maskinen er fullstendig strømløs. På MARLIN, FALCON, POLAR seriene og alle 3 fas maskiner er det nødvendig å skru av hovedbryter før maskinen er helt strømløs. Vær sikker på at maskinen er helt strømløs når det utføres service og vedlikehold.

### BOXER serien

Når maskinen er skrudd på (med AV/PÅ bryteren), kjører pumpa kun undrer vakumerings syklusen.

### MARLIN / FALCON / POLAR seriene

Når maskinen er skrudd på (med AV/PÅ bryteren), kjører pumpa kontinuerlig. 3 fas pumpene trenger lengre oppvarming av ved å skru de av og på har negativ innvirkning på levetiden. Hvis maskinen er skrudd på men er ikke i bruk, vil pumpa skru seg av automatisk etter 10 minutter. Dette for å unngå overoppheting av olja, og redusere unødvendig forurensing fra eksos filtrene. Denne funksjonen kalles Sleeper function

### SLEEPER FUNCTION

På modellene Marlin, Falcon og Polar er Sleeper Function alltid aktivert. Dette betyr at hvis maskinen er skrudd på men ikke i bruk, stoppe pumpa automatisk etter 10 minutter. Ved å stenge lokket starter prosessen og pumpa samtidig. Kontakt din leverandør for nærmere informasjon om Sleeper Function.

## OPPSTART AV MASKINEN

Etter at maskinen er tilkoblet og eventuelt hovedbryter er satt på 1, kan maskinen settes på med AV/PÅ bryteren. Når maskinen starter vises 2 koder i displayet før kontroll panelet settes i drift modus.



Den første koden indikerer modellen på maskinen. Den andre koden viser kontrollens software versjon. Noter ned begge disse koder på side 4 siden de er viktige for din leverandør eller Henkelman BV når du har spørsmål eller om det oppstår et problem.



Etter at maskinen har skiftet til driftsmodus er den klar til bruk. Hvis maskinen er ny eller har vært ute av drift en lengre periode, anbefaler vi å kjøre vedlikeholdsprogrammet for pumpa (15 minutter) for å varme opp og rense pumpa. For instruksjon vedlikeholdsprogrammet for pumpa, se side 22



Etter at maskinen har kommet i driftsmodus kan de hende at [ OIL ] vises i displayet. Dette betyr at driftstids telleren er aktivert og antall driftstimer som er satt er overskredet. Driftstidstelleren er forhåndsinnstilt, men kan endres av bruker for å benyttes til en påminnelse om regelmessige vedlikeholds aktiviteter. Når [ OIL ] vises kan maskinen fremdeles brukes som vanlig men vi anbefaler å skifte olje og resette denne advarsel funksjonen.

Kontakt din leverandør for mer informasjon om hvordan endre driftstidstelleren..

## STEGVIS BRUKSANVISNING FOR MASKINEN

1. Skru på maskinen med AV/PÅ bryteren. Varm opp pumpa med Condition programmet hvis maskinen har vært ute av bruk en tid (instruksjon på,side 22).

2. Fyll vakumposen med produktet. Velg riktig posestørrelse. Posen må enkelt passé rundt produktet men bør ikke være for stor. Vær sikker på at alle hygienekrav er ivarettatt under denne operasjonen. Pakkemateriale, produktet og hender må være rene og tørre hvis mulig.

3. Plasser vakumposen i kammeret. Den åpne enden må plasseres over sveiseskinna. Posen må ikke komme utenfor kammeret. Hvis produktet er mye lavere enn høyden sveiseskinna brukes de sorte innleggsplatene som følger med maskinen. Dette forenkler prosessen og reduserer syklusen tiden.

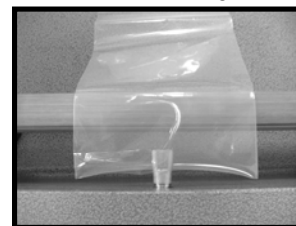

på

4. Vakum posen må plasseres over sveiseskinna (BOXER og MARLIN) eller silikon holderen (FALCOM og POLAR) uten bretter.



5. Med gass flush system må åpningen av posen trekkes over gass dysene (se illustrasjon).

6. Flere vakumposer kan plasseres over sveiseskinna /silikonholder hvis sveiseskinna/silikonholder er lengre enn vakum posen. Vakum posene må ikke legges oppå hverandre på skinna/holderen. Hvis det er flere skinner/holdere kan alle skinner /holdere benyttes i den samme syklusen.

7. Bruk [PROG] bryteren til å velge ønsket program. Se side 18 vedrørende instruksjon for programmering.

FALCON / POLAR series

8. Steng lokket og maskinen kjører automatisk hele syklusen med alle aktiverte funksjoner. Lokket åpnes automatisk etter at den siste funksjonen "utlufting" er fullført.

9. If necessary the cycle can be partially or fully interrupted by pressing the [VACUUM STOP] key or the [STOP] key. Om nødvendig kan syklusen delvis eller helt avbrytes ved å trykke på [VACUUM STOP] bryteren eller [STOP] bryteren. [VACUUM STOP] bryteren avbryter den aktive funksjonen (vakum, gass flush, forseiling eller soft- air utlufting) og går automatisk videre til neste funksjon.

[STOP] bryteren avbryter hele syklusen og går direkte til utlufting.

10. Etter at syklusen er fullført kan det pakke produktet eller produktene tas ut av maskinen.

11. Hvis maskinen er utstyrt med et cut-off sealing system, kan den overflødig delen rives av.



#### **SIKKERHET og PRODUKT BESKYTTELSE**

Pakke prosessen kan helt eller delvis avbrytes hele tiden

- Stopp aktiv funksjon, trykk på [VACUUM STOP] bryteren
- Stopp hele syklusen, trykk på [STOP] bryteren

#### **OPTIMALT og EFFEKTIVT PAKKE RESULTAT**

- Bruk vakumposer av god kvalitet og riktig størrelse
- Maximum 75% produkt fylling i vakum posen
- Plasser vakum posen fritt over sveiseskinna/silikonholderen (benytt riktig antall innleggsplater i kammeret)
- Trekk vakum posene langt nok over gass dysene (for gass flush) slik at ikke gass går tapt og posen ikke flytter seg ved gass flushing

## Betjeningspanel

### Generell informasjon

Det digitale betjeningspanelet er inkludert med 9 ferdige program som individuelt kan endres i de forskjellige verdier (for å vacuumpakke forskjellige produkter). Program 0 kan ikke bli brukt for testing eller service. Et programsyklus er et komplett program av flere funksjoner som maskinen går gjennom under vacuumpakking av et produkt.

Betjeningspanelet er utformet med en betjeningsmodus og en programmodus.

Betjeningsdelen blir brukt under utførende av valg av programnummer med ønsket programsyklus.

Programdelen blir brukt til å bytte verdier innenfor programmene.

Betjeningspanelet er også for automatisk feilsøking under service/vedlikehold av pumpen og et 2 stegs nøkkel for en fullstendig avbrudd eller funksjonsavbrudd. Det har også innebygget flere service-/vedlikeholdsprogram.

### Digital tidsur

Alle aktive funksjoner kan tidsuopereres. Det vil si at vakuumsfunksjonen, gassfunksjonen (hvis installert) og õsoft-airõ funksjonen kan innstilles i sekunder opp til 99 sekunder. Sveisefunksjonen kan innstilles i 0,1 sekunder og maksimum 6,0 sekunder.

### Følerkontroll

Verdiene i vacuumfunksjonen og gassfunksjonen (hvis installert) kan velges som en prosentandel av vacuumet. Dette er prosentandel av trykket i vacuumkammeret relatert til trykket utenfor på 1 ATO (0%).

Den maksimale vacuumprosenten som kan settes er 99 %.

Den laveste vacuumprosenten ved bruk av gass er 30 % under trykk i relasjon til 1 ATO. Det betyr at vacuumkammeret er pumpet opp til 30 % under sammenlignet med 1 ATO. Dette er ofte uttrykt som 70 % er pumpet med gass ( $99\% - 30\% = 70\%$ ).

õSoft airõ funksjonen kan også tidsuopereres i sekunder (maksimum 99 sekunder). Sveisefunksjonen kan tidsuopereres med 0,1 sekunders intervall (maksimum 6,0 sekunder).

VACUUM PLUS funksjonen er alltid standard med digital føler kontrollerbar. VACUUM PLUS funksjonen er en tidsoperert tilleggs-vacuumsfunksjon som kan innstilles med ekstra tid for å oppnå 99 % verdi av vacuumfunksjonen (kan kun brukes hvis 99 % er innstilt for vacuumfunksjonen. Denne funksjonen krever ekstra vacuumtid for å unngå å få små luftmengder i vacuumpakkingen.

### Hurtig-stopp H20 betjening

Prinsippet for hurtig-stopp H20 funksjonen er et veldig sensitivt følersystem. Hvis H20 vises i displayet indikerer dette at funksjonen er aktiv. Denne muligheten kan aktiveres i hvert individuelt program.

Den øverste grensen for vacuumprosenten som kan settes er 99 %. Den spesielle sensitive føleren H20 er i stand til å føle øyeblikket for når fuktigheten i produktet begynner å evaporere (koke). I dette øyeblikk vil det sensitive følersystemet avbryte og gå til neste trinn/fase og på den måten unngå at produktet tørker ut, taper vekt eller koke ut vacuumposen som da vil forurense sveisestedet med et resultat at fuktighet ender opp i vacuumpumpen og tilslutt gir et optimalt vacuumresultat uten bruk av unødvendig tid.

Hurtig-stopp H20 føleren er standard i H20 PLUSS funksjonen. H20 PLUS er tidsuoperert funksjon som muliggjør ekstra tid etter oppnådd 99 % verdi av vacuumfunksjonen. Tidsinnstillingen for H20 PLUS funksjonen kan settes med 0,1 sekunders intervall opp til maksimum 5,0 sekunder.

## Betjeningspanel



- |                               |   |
|-------------------------------|---|
| <b>1. Lite display.</b>       | Viser aktivt program eller programmodus   |
| <b>2. Stort display.</b>      | Viser aktuell verdi på funksjon mens programmet utføres eller innstilt verdi i det spesifikke programmet  |
| <b>3. PROG 0-9 tast</b>       | Valg av lagrede programmer/programmodus   |
| <b>4. REPOG tast</b>          | Bytter mellom betjeningsmodus til programmodus (for å innstilling av verdier) og vice versa. Etter å ha innstilt nye funksjonsverdi(er) innenfor programmet i programmodus, må denne tasten alltid brukes for å lagre den nye verdien i maskinens hukommelse. |
| <b>5. Funksjonstast</b>       | Med den velges funksjon innenfor valgte program og programmodus. Valgt funksjon indikeres ved at pilotlampen er tent foran programmet (under det store displayet).  |
| <b>6. Programtilstand</b>     | Start tilstandsprogrammet for vacuum pumpen (tar ca. 15 minutter). For programinnstillinger se side 22.   |
| <b>7. Pilotlampe-funksjon</b> | En tent pilotlampe i front av funksjonsbeskrivelsen indikerer at funksjonen er aktiv igjennom programsyklusen eller at funksjonen er valgt under utføringen av programmodus.  |

### NB!

Det finnes i tillegg en tidsuroperert vacuumfunksjon tilgjengelig med digital følerkontroll med navnet VACUUM PLUS. Denne funksjonen er ikke vist på betjeningspanelet. VACUUM PLUSfunksjonen kan kun aktiveres hvis standard vacuumfunksjon er innstilt på 99 %.

VACUUM PLUS vises under programsyklusen (hvis aktivert). Pilotlampen vil fortsatt lyse etter at man oppnår 99 % og under tidsinnstillingen for VACUUM PLUS. Under VACUUM PLUS vacuum syklusen et lysende punkt vil vises i nedre høyre hjørne av det store displayet.

Display under funksjon og programmodus:

Hvis VACUUM PLUS tidsstyrt er aktivert under valgt program vil et lysende punkt vises i nedre høyre hjørne av det store displayet under funksjon og programmodus. Hvis funksjonen er valgt ved å bruke ⏻Funksjonstasten⏻ vil pilotlampen til venstre for VACUUM tennes to ganger og vacuumprosenten og VACUUM PLUS tiden vil vises konstant i displayet.

Hvis maskinen er utstyrt med integrert gasstilsetningsmulighet og funksjonen er aktiv valgt program (No) vil et punkt nederst til høyre i det lille displayet lyse opp.

## 8. + /VACUUM STOP

(fungere under drift)

Bryter den aktive funksjonen under programsyklusen. Syklusen fortsetter da øyeblikkelig med neste funksjon.

(Funksjon i programmodus) Øker verdien av den valgte funksjon innenfor valgte program i programmodus.

## 9. - / STOP

(funksjon under syklus)

Stopper programsyklusen øyeblikkelig og går over til ventilasjonsyklusen.

(Funksjon i programmodus) Senker verdien av den valgte funksjon innenfor valgt program i programmodus.

## 10. Vacuummeter

Viser trykket i vacuum-kammeret. Se tabell nedenfor for samsvaret mellom vacuummeteret og prosentandel vacuum.

Vacuummeterskala	Vacuum i prosent (%)
0	0
0,2	20
0,3	30
0,4	40
0,5	50
0,6	60
0,7	70
0,8	80
0,9	90
- 1,0	99+

## 11. ON/OFF

Hovedstrømbryter. Brukes for å sette maskinen på før bruk og for å slå maskinen av etter bruk. Ved ON settes alle funksjonene i maskinen i drift.

**ADVARSEL. Når maskinen er i OFF modus er strømmen ikke koblet fra maskinen (hukommelse). For å få maskinen strømløs må man koble fra stikkontakt.**

### NÅR MASKINEN ER SLÅTT PÅ (ON)

Når maskinen er slått på går maskinen over til operativmodus etter å ha vist 2 START-koder i displayet. NB! Vær vennlig og noter ned de 2 START-kodene i denne bruksanvisningen side 4 (teknisk informasjon og DATA-platen). Operativmodus er standard på betjeningspanelet når man skal vacuumere produkter. Modifisering av verdier kan ikke utføres under operativmodus.

Med PROG tasten og valgbrytere kan man velge verdier innenfor de forskjellige programmer som vises. Hvis maskinen er klar for vacuumpakking (og produktet ligger allerede i kammeret) er det bar å velge program (PROG tasten) og lukke lokket. Programsyklusen starter da automatisk og går igjennom de valgte funksjonene i programmet.

## Beskrivelse av programsyklus med digital tidsinnstilling

### 1. Velg programnummer med PROG tasten og det lille displayet.

Hvis det valgte program er med aktiv gasstilsetning vil en punkt nederst i høyre hjørne i det lille displayet lyse opp.

### 2. Lukk igjen lokket

### 3. Vacuum funksjon

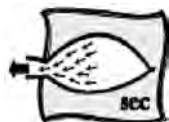

Maskinen starter å vacuumere kammeret.

Pilotlampen foran VACUUM lyser.

Det store displayet: Tidsnedtelling starter etter innstilt tid (maksimum 99 sekunder). Vacuummeteret øker moturs.

### 4. Gasstilsetning (hvis installert)

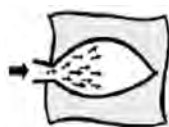

Med en gang vacuumeringen er ferdig vil gasstilsetningen starte.

Pilotlampen foran GAS vil lyse opp

Det store displayet: Tidsnedtelling starter som innstilt (maksimum 99 sekunder). Vacuummeteret minker medurs.

### 5. Gas flush Plus (hvis aktivert)



I det øyeblikket gasstilsetning er ferdig er det mulig å legge til tid for tillegg av gass. Med denne muligheten kan man tilsette mer gass mens sveisefunksjonen avsluttes.

### 6. Sveising



Når vacuumfunksjonen eller gasstilsetningsfunksjonen (hvis installert) er ferdig vil sveisefunksjonen starte med sveising av vacuumposen.

Pilotlampen foran SEAL vil da lyse opp.

Det store displayet: Tidsnedtelling med 0,1 sekund starter etter innstilt tid (maksimum 6.0 sekunder).

Vacuummeteret vil bli uforandret.

### 7. Soft-air ventilasjon (hvis installert)

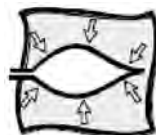

Når sveisefunksjonen er over vil soft-air funksjonen starte sakte med å slippe luft inn i vacuumkammeret.

Pilotlampen foran SOFT AIR vil lyse opp.

Det store displayet: Tidsnedtelling starter som innstilt (maksimum 99 sekunder). Vacuummeteret minker medurs.

### 8. Ventilering



Etter endt sveise- og Soft-air funksjon (hvis installert) starter ventilasjon av kammeret til 1 ATO og lokket åpner seg.

Alle pilotlampene foran funksjonene er slukket.

Det store displayet: streker går opp og ned til lokket er helt åpent.

Vacuummeteret går tilbake til 0 og lokket åpnes automatisk.

### 9. Produktet er nå ferdig vacuumert og kan tas ut/flyttes.



## Beskrivelse av programsyklus med digital føler kontrollert

### 1. Velg programnummer med PROG tasten og det lille displayet.

Hvis det valgte program er med aktiv gasstilsetning vil en punkt nederst i høyre hjørne i det lille displayet lyse opp.  
Hvis det valgte program er med aktiv VACUUM PLUS vil en punkt nederst i høyre hjørne i det store displayet lyse opp.

### 2. Lukk igjen lokket

### 3. Vacuum funksjon



Maskinen starter å vacuumere kammeret.  
Pilotlampen foran VACUUM lyser.  
Det store displayet: Nedtelling av prosent vacuum starter etter innstilt % (maksimum 99 %).  
Vacuummeteret øker moturs.

### 4. VACUUM Plus. (hvis installert)

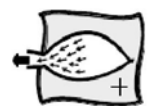

Maskinen fortsetter å vacuumere etter oppnådd 99 %.  
Pilotlampen foran VACUUM lyser opp.  
Det store displayet: Tidsnedtelling starter etter innstilt tid (maksimum 99 sekunder) og punktet nede i høyre hjørne lyser opp.  
Vacuummeteret øker moturs veldig sakte (nesten umerkelig).  
Bemerk: Kan kun installeres med vacuumfunksjonen når verdien er satt til maksimum 99 %.

### 5. Gasstilsetning (hvis installert)



Med en gang vacuumeringen er ferdig vil gasstilsetningen starte.  
Pilotlampen foran GAS vil lyse opp.  
Det store displayet: Nedtelling av prosent vacuum som innstilt (minimum 30 %).  
Vacuummeteret minker moturs

### 6. Gas flush Plus (hvis aktivert)



I det øyeblikket gasstilsetning er ferdig er det mulig å legge til tid for tillegg av gass.  
Med denne muligheten kan man tilsette mer gass mens sveisefunksjonen avsluttes.

### 7. Sveising (hvis installert)



Når vacuumfunksjonen eller gasstilsetningsfunksjonen er ferdig vil sveisefunksjonen starte med sveising av vacuumposen.  
Pilotlampen foran SEAL vil da lyse opp.  
Det store displayet: Tidsnedtelling pr. sekund starter etter innstilt tid (maksimum 6.0 sekunder).  
Vacuummeteret vil bli uforandret.

### 8. Soft-air ventilasjon



Når sveisefunksjonen er over vil soft-air funksjonen starte sakte med å slippe luft inn i vacuumkammeret.  
Pilotlampen foran SOFT AIR vil lyse opp.  
Det store displayet: Tidsnedtelling pr. sekund starter som innstilt (maksimum 99 sekunder).  
Vacuummeteret minker medurs.

### 9. Ventilering



Etter endt sveise- og Soft-air funksjon (hvis installert) starter ventilasjon av kammeret til 1 ATO og lokket åpner seg.  
Alle pilotlampene foran funksjonene er slukket.  
Det store displayet: streker går opp og ned til lokket er helt åpent.  
Vacuummeteret går tilbake til 0 og lokket åpnes automatisk.

### 10. Produktet er nå ferdig vacuumert og kan tas ut/flyttes.

## Beskrivelse av programsyklus med digital Quick Stop H20 kontrollert

### 1. Velg programnummer med PROG tasten og det lille displayet.

Fundamentet for Quick Stop H20 funksjonen er et meget følsomt kontrollsystem. Tilvalget kan aktiveres til hvert program ved at H20 vises i displayet og som indikerer at funksjonen er aktiv. For å aktivere Quick Stop H20 kontrollen, trykk på REPROG tasten, programnummer vil blinke. Trykk så på Programvalg tasten og H20 vil vises i displayet. Trykk igjen på REPROG tasten for å gå tilbake til driftsmodus. Programnummeret vil ikke lenger blinke som indikerer at maskinen er klar til bruk.

### 2. Lukk igjen lokket

### 3. Vacuum funksjon



Maskinen starter å vacuumere kammeret.  
Pilotlampen foran VACUUM lyser.  
Det store displayet: H20 vil vises  
Vacuummeteret øker moturs.

### 4. VACUUM Plus



Maskinen fortsetter å vacuumere til H20 punktet er oppnådd eller at 99 % er (hvis installert) oppnådd.  
Pilotlampen foran VACUUM lyser opp.  
Det store displayet: Tidsnedtelling pr. sekund starter etter innstilt tid (maksimum 5 sekunder) og punktet nede i høyre hjørne lyser opp.  
Vacuummeteret øker moturs veldig sakte (nesten umerkelig).

### 5. Gasstilsetning (hvis installert)



Med en gang vacuumeringen er ferdig vil gasstilsetningen starte.  
Pilotlampen foran GAS vil lyse opp  
Det store displayet: Nedtelling av prosent vacuum som innstilt (minimum 30 %).  
Vacuummeteret minker moturs

### 6. Gas flush Plus (hvis aktivert)



I det øyeblikket gasstilsetning er ferdig er det mulig å legge til tid for tillegg av gass. Med denne muligheten kan man tilsette mer gass mens sveisefunksjonen avsluttes.

### 7. Sveising



Når vacuumfunksjonen eller gasstilsetningsfunksjonen (hvis installert) er ferdig vil sveisefunksjonen starte med sveising av vacuumposen.  
Pilotlampen foran SEAL vil da lyse opp.  
Det store displayet: Tidsnedtelling pr. sekund starter etter innstilt tid (maksimum 6.0 sekunder). Vacuummeteret vil bli uforandret.

### 8. Soft-air ventilasjon



Når sveisefunksjonen er over vil soft-air funksjonen starte sakte med å slippe luft inn i vacuumkammeret.  
Pilotlampen foran SOFT AIR vil lyse opp.  
Det store displayet: Tidsnedtelling pr. sekund starter som innstilt (maksimum 99 sekunder).  
Vacuummeteret minker medurs

### 9. Ventilering



Etter endt sveise- og Soft-air funksjon (hvis installert) starter ventilasjon av kammeret til 1 ATO og lokket åpner seg.  
Alle pilotlampene foran funksjonene er slukket.  
Det store displayet: streker går opp og ned til lokket er helt åpent.  
Vacuummeteret går tilbake til 0 og lokket åpnes automatisk.

### 10. Produktet er nå ferdig vacuumert og kan tas ut/flyttes.

## PROGRAMMODUS

Programmodusene er brukt til å bytte funksjonsverdier innenfor programmer. Se side 4-6 med instruksjoner for programmeringen.

## ANDRE MODUS

Betjeningspanelet kan også benyttes for service. Programmet som er tilpasset dette er for pumpen og tidsur/nedtellingsfunksjon som er de mest brukte i dette programmet.

### Betjening av timetelleren (Driftstidstelleren)



En av servicefunksjonene er timetelleren som automatisk gir beskjed om når man trenger service. Denne registrerer hvor mange timer pumpen er operativ (pr.10 timer). **MERK!** Boxer serien har en pumpe som ikke er aktiv hele tiden. I det øyeblikk innstilt tid er nådd vil beskjeden OIL vises i displayet (se side 11 i den kombinerte engelske og norske anvisningen). Maskinen kan fortsatt brukes som vanlig, men varslingen vil stadig vises i displayet. Bestill service uten å vente.

Fabrikkens standardinnstilling for dette programmet OFF (slått av). Følgende steg kan benyttes for å aktivere Driftstidstelleren eller nullstille denne.



Trykk på tasten FUNCTION SELECT for minst 3 sekunder. Etter 3 sekunder vil driftstidstelleren vise antall 10 timer som vacuumpakkemaskinen har vært i drift. Antallet vil vises i 2 sekunder. Etter 2 sekunder vil det originale innstilte timer vises (pr. 10 timer). Når driftstimetelleren er slått av (ikke i bruk) vil brukte timer ikke vises ( i stedet vil det vises beskjeden OFF) etter at tasten er trykket inn for 3 sekunder.

Den originale innstillingen av kan modifieres ved å bruke tasten + og 6 (mellom 0 og 990 timer). Hvis man stiller inn på 0 vil displayet neste gang automatisk vise OFF etter trykk for minst 3 sekunder.

Den nye innstillingen vil lagres ved å trykke på REPROG tasten. Den virkelige driftstiden vil da bli satt til null.







Etter trykk på tasten REPROG vil betjeningspanelet bytte over til normal driftsmodus.

## PROGRAMMERING



Verdifunksjonen i valgte programnummer kan alltid endres enten manuelt eller med automatisk programmering. For enhet, område eller begrensninger av verdifunksjon henviser vi til forrige kapittel.

10 programmer kan velges (fra 0 til 9). Program 0 kan ikke benyttes av bruker. Dette programmet er for service. Kun autoriserte personer kan benytte (endre verdier) dette programmet (trykke REPROG tasten for minst 5 sekunder). Etter valg av program 0 må man bytte til PROGRAM MODE.



### MANUELL PROGRAMMERING (oppstart med maskinen PÅ og med lokket åpent)

A.		Velg ønsket program med tasten PROG 0-9 for å stille inn verdier. Programnummeret vises i det lille displayet.
B.		Trykk på tasten REPROG for å komme inn i programmodusen. Programnummeret begynner nå å blinke i det lille displayet.
C.		<p>Velg ønsket funksjon for programmet med å trykke på FUNCTION SELECT tasten. Pilotlampen vil lyse opp for valgte funksjon.</p> <p><u>OBS! Under SEAL (sveising) mulighet 1-2 Cut-Off seal</u></p> <p>Under valgmulighet 1-2 cut-off seal vil pilotlampen lyse opp to ganger. Første gangen for innstilling av sveisetid og andre gangen for innstilling av kuttetiden.</p> <p><u>OBS! Valgmulighet Digital Sensor Control and Quick Stop H2O Control.</u></p> <p>Under valgmulighet sensor control, pilotlampen foran VACUUM vil lyse opp to ganger. Første gangen er for Vacuum funksjonen (vacuum prosent) og andre gangen for Vacuum Plus funksjonen (med tid). Se side 8 og 9 i den engelske bruksanvisningen.</p>
D.		<p><u>Digital Tids Controll</u></p> <p>Innstill ønsket verdi ved å trykke på + og – tasten</p> <p><u>Digital sensor Control og Quick Stop H2O Control</u></p> <p>Still inn ønsket verdi prosent av vacuum eller ønsket tid for valgt funksjon ved å trykke på + og – tasten.</p> <p>OBS!</p> <p>Verdiene vil vises i det store displayet.</p> <p>Funksjonen VACUUM PLUS (sensor control), Gasstilsetning og Soft-Air kan slås av i programmet hvis ønskelig. For å slå av trykk på – tasten inntil OFF vises i det store displayet.</p>
E.		Gjenta steg C og D for innstilling av andre verdier.
F.		Trykk på tasten REPROG etter innstilling av relevante funksjoner for så å lagre disse i programmet. Maskinen går da tilbake til normal drift og den kan brukes til vacuumering. De nye innstilte verdier er nå standardverdier inntil de blir endret på nytt.

## AUTOMATISK PROGRAMMERING (oppstart med maskinen PÅ og med lokket åpent)

A.		Velg ønsket program med tasten PROG 0-9 for å stille inn verdier. Programnummeret vises i det lille displayet.
B.		Trykk på tasten REPROG for å komme inn i programmodusen. Programnummeret begynner nå å blinke i det lille displayet.

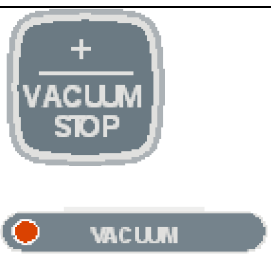
Lukk lokket. Maskinen starter automatisk

C.		<p><b>VACUUM funksjon</b>  <u>Digital Tidskontroll</u>  Tiden øker. Så snart som Vacuummeteret når -1 trykk så på STOP VACUUM-tasten. Automatisk vil maskin-syklusen bytte til følgende funksjon:  <u>Bemerk Digital Tids-kontroll</u>  La vacuumfunksjonen gå for 2 til 4 sekunder etter at -1 er oppnådd på vacuummeteret slik at mulig små rester av luft også er trukket ut.  Digital Sensor Control  Den prosentuelle andel vacuum øker. Så snart som verdien 99 % er oppnådd trykk på STOP VACUUM tasten. Automatisk vil maskin-syklusen bytte til følgende funksjon: (NB! Hvis full vacuumering ikke er ønsket trykk på STOP VACUUM tasten når ønsket verdi er oppnådd).</p>
D.		<p><b>VACUUM PLUS funksjon</b>  Digital Sensor Control + Quick Stop H2O Control  Tiden øker. Trykk på STOP VACUUM tasten når ønsket tid oppnås. Da bytter maskinen automatisk til følgende funksjon.  (NB! VACUUM PLUS funksjonen kan kun deaktiveres med OFF tasten ved manuell programmering. VACUUM PLUS funksjonen kan kun brukes når VACUUM funksjonen er blitt innstilt på 99 %).</p>
E.		<p><b>GASSTILSETNINGS funksjonen</b> (ikke standard/kan fås som tillegg)  <u>Digital Tids-drift</u>  Tiden øker. Trykk på STOP VACUUM så snart vacuummeteret oppnår ønsket undertrykk. Maskinsyklusen vil da automatisk bytte til følgende funksjon  Digital Føler-kontroll  Den prosentuelle andel vacuum øker. Trykk på VACUUM STOP tasten i det øyeblikk maskinen nå ønsket verdi. Maskinsyklusen vil da automatisk til neste funksjon. (NB! Det anbefalte minimale undertrykket er 0,5 bar eller 50 % vacuum. Det minste undertrykket som kan innstilles er 0,3 bar eller 30 %. GAS FLUSH/gasstilsetning funksjonen er kun mulig å deaktivere med OFF tasten ved manuell programmering).</p>
F.	SVEISING OG SOFT-AIR funksjonene. Begge muligheter kan kun stilles inn manuelt	

Etter at syklusene er innstilt vil de automatisk bli lagret.

## VÆR SPESIELT OPPMERKSOM PÅ FØLGENDE VED PROGRAMMERING

### For DIGITAL SENSOR CONTROL (Digital Føler Kontroll)

Verdiene som blir programmert ved gasstilsetningsfunksjonen er den endelige vacuumprosenten i vacuumkammeret etter gasstilsetningen.

Eksempel: Vacuum funksjonen er satt til 99 % og gasstilsetningen er satt til 60 %. Det betyr at etter vacuum funksjonen vil vacuumkammeret få gasstilsetning til det oppnås 60 % vacuum og 40 % (39 %) gass i vacuumkammeret.

### For automatisk programmering

Vær sikker på at alle funksjoner er aktivert i det valgte programmet. Aktivert betyr at funksjonen i programmet er tildelt en verdi. Hvis verdien er OFF betyr det at verdien ikke er aktivert og vil ikke bli inkludert i det automatiske programsykluset.

### For maskiner med gasstilsetningsfunksjonen

Hvis man programmerer et program med aktiv gasstilsetning vil dette indikeres ved at et punkt nede i høre hjørne av det lille displayet vil lyse opp når man velger et program med denne modusen.

### For maskiner med tillegg av Sensor Control (digital Føler Kontroll)

Hvis et program er satt opp med aktiv VACUUM PLUS funksjonen vil dette indikeres ved at et punkt nede i de høyre hjørne i det store displayet lyse opp når man velger program med denne modusen.

Hvis funksjonsverdien er OFF er det kun mulig å aktivere denne ved manuell programmering.

---

## MACHINE MAINTENANCE

---

### GENERAL

A regular and complete maintenance is required for long usage of the machine, to avoid malfunctioning and to achieve an optimal packaging result. If the machine is used intensively (more than 5 hours per day), we recommend professional servicing every 6 months. For normal use of the machine, complete servicing once a year should be sufficient (depending on location, environment and products).

However, there are small maintenance activities that must be carried out regularly. These maintenance activities can be done by the user. The following page contains an overview of these activities.



### *IMPORTANT BEFORE AND DURING MAINTENANCE*

- The machine must always be completely voltage free before any maintenance is carried out on it. Remove the plug from the wall socket or put the master switch in the O position.
- If the machine is not functioning properly or if it produces strange noises, turn it off immediately with the ON/OFF switch and contact the supplier or Henkelman BV.
- If the machine is equipped with a gas flush system then always close the main crane during standard maintenance activities. Always note that the pressure on the pressure reducing valve on the gas bottle is never higher than 1 atmosphere/ATO before, during and after the maintenance activities. A higher pressure may cause irreparable damage to the machine. **NEVER** use flammable gasses or gas mixtures containing oxygen.
- When cleaning transparent lids (if applicable), **NEVER** use cleaning agents containing solvents. Check at least once a week if there are cracks in the lid. In case of cracks, turn off the machine immediately and contact the supplier or Henkelman BV.
- High pressure cleaning is not permitted for cleaning the machine. High pressure cleaning can cause considerable damage to electronic and other parts of the machine.
- Water may never be permitted to enter either the extraction nozzle of the chamber or the blow-off opening of the pump. This would cause irreparable damage to the pump.
- Larger services must always be carried out by an authorised supplier.
- The BOXER serie machines are designed for a maximum of 5 hours operation per day. Other machines are designed for a maximum of 8 hours per day. The supplier or Henkelman BV cannot be held responsible for any malfunctions or defects if these operation time limits are clearly exceeded without consultation.
- The machine must be moved or transported in an upright position. The machine may **NOT** be tilted as it can cause damage to the pump.
- The supplier or Henkelman BV cannot be held responsible for any malfunctions or defects if the maintenance instructions in this manual are not followed.
- Contact the supplier or Henkelman BV if there are any doubts or questions about maintenance or malfunctions.

## STANDARD MAINTENANCE SCHEDULE FOR THE MACHINE

- Daily**
- Clean the vacuum chamber, lid, and housing after use with a damp cloth.
  - *Make sure that no cleaning agents containing solvents are used.*
  - *Make sure that no high pressure cleaner is used.*
- Weekly**
- Check the oil level and replace or fill up oil when the oil is turbid or the oil level is too low. For instructions, see page 23.
  - Activate the conditioning program for the pump at least once a week.
  - Inspect the sealing bar for damage. Replace Teflon tape/sealing wire if the seal quality is no longer sufficient or if the Teflon tape/sealing wire is no longer tight and straight on the sealing bar. For instructions, see page 26.
  - Inspect the lid gasket and replace it when the gasket is damaged or stretched. For instructions, see page 27.
  - Inspect the transparent lid (if applicable). When cracks are visible, turn off the machine immediately and contact the supplier or Henkelman BV.
- Every Six Months**
- Replace oil at least once every 6 months.
- Yearly**
- Inspect the oil exhaust filter for saturation. If saturated, replace the filter. For instructions, see page 24.
  - Contact the supplier for a professional service
- Four-yearly**
- Replace transparent lid and the lid's gas springs (if applicable)
  - Replace membranes seal cylinder (if applicable)

## VACUUM PUMP MAINTENANCE

It is very important to regularly service the pump to ensure extended and correct operation. The following activities are essential for correct maintenance. If the machine is used regularly then it is advisable to have the pump fully inspected at least once a year by the supplier to ensure extended and problem free operation. Contact the supplier or Henkelman BV for more advice and information.

### Conditioning Program



The conditioning program ensures that the pump is thoroughly rinsed. During the program the pump and oil reaches operation temperature so that the oil can better absorb any moisture and contaminants and filter them. The high temperature enables any moisture in the pump to evaporate minimising the risk for rust spots.

The program lasts 15 minutes and it is advisable to run it at least once a week. Turn on the machine, press the key [conditioning program], and close the lid. The program runs automatically. During the program the large display will display moving lines.

The program can be interrupted at any time using the [STOP] key. It is however important for the sake of good maintenance that the program completes a full 15 minute cycle and therefore advisable only to interrupt the cycle for something urgent.

It is also advisable to run the program before using the machine for the first time, after the machine has been stationary for a lengthy period of time, and especially prior to changing oil.



## Changing Oil / Filling Up

The oil level and oil quality must be checked at least once a week. The oil inspection window serves this purpose. Fill up the oil level if it is too low. Replace the oil if it is turbid. Oil must be replaced at least once every 6 months.

### BOXER series

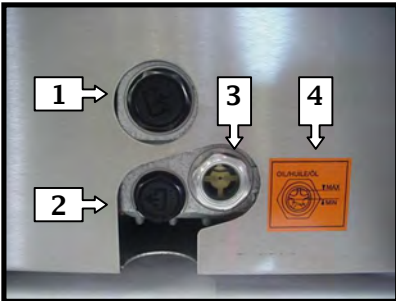

1. Oil fill plug
2. Oil drain plug
3. Oil inspection window
4. Oil level indicator sticker

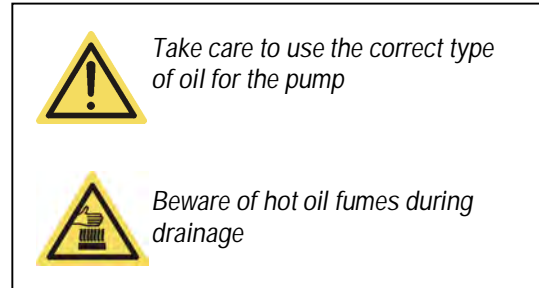

### MARLIN / FALCON / POLAR series

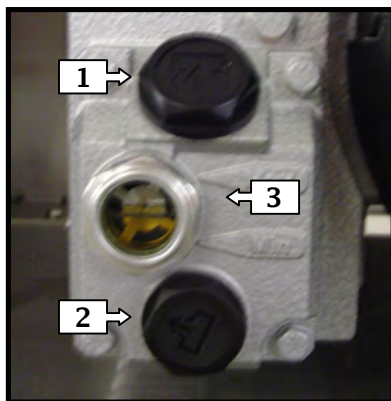

#### Draining oil

If the oil is white or turbid when checked then it must be replaced. Before draining off the oil let the conditioning program run a full cycle. The dirt and moisture is absorbed by the oil and the oil becomes thinner making draining easier.

After the program has ended the drainage plug can be removed.

**CAUTION**, when unscrewing hot oil fumes can escape. The oil now drains from the drain hole (an oil pan must be placed underneath). For the BOXER series, when the oil has drained, tilt the machine slightly so that all residual oil can drain off. After draining the oil drain plug is replaced.

Location at rear or side of machine  
View can differ per model

#### Filling up oil

After draining or if the oil level has dropped, oil needs to be filled up. The oil fill plug must be removed with the correct size spanner. The pump can now be filled with oil. Make sure that you add the correct amount (see table on page 24)

**TAKE CARE** to fill with small amounts at intervals. Fill the oil level to the top of the oil level indicator sticker.

**TAKE CARE** to replace the oil filter before adding the new oil (see page 24)

#### Oil types and amounts

It is important to use the correct type and quantity of oil for the pump. The wrong type or too much oil could damage the pump. The ambient temperature where the machine is operated is also important for the type of oil. See amounts and types with related ambient temperatures in the table on the next page.

Examples of supplier brands for the standard types of oil are Shell Vitrea, Aral Motanol GM, BP Energol CS, or Texaco Regal R+O with related viscosity numbering. If the machine is used outside normal specifications regarding ambient temperature, contact the supplier or Henkelman BV.

Machine Type	Pump Capacity	Filling (litres)	Ambient Temperature		
			Standard Oil Type 10 - 30 °C	“Cold” Oil Type 5 - 10 °C	“Hot” Oil Type 30 - 40 °C
BOXER 35	016 m³/h	0.4	Viscosity VG 32	VM 32	VS 32
BOXER 42 / 42 XL	021 m³/h	0.4	Viscosity VG 32	VM 32	VS 32
MARLIN 46	040 m³/h	1.0	Viscosity VG 32	VM 32	VS 32
MARLIN 52 / 90 - FALCON 52 / 2-60 – POLAR 52 / 2-40	063 m³/h	1.0	Viscosity VG 100	VM 100	VS 100
FALCON 2-60 - POLAR 2-50	100 m³/h	2.0	Viscosity VG 100	VM 100	VS 100
POLAR 2-75	160 m³/h	5.0	Viscosity VG 100	VM 100	VS 100
POLAR 2-85 / 2-95	300 m³/h	7.0	Viscosity VG 100	VM 100	VS 100

Machines are supplied with standard type oil.

The capacity of models with a 063 m³/h pump and 60Hz voltage, is 2.0 litre instead of 1.0 litre.

### Changing the oil filter

The pumps of all floor models have oil filters. When replacing the oil the filters must also be replaced. The oil filter is screwed to the rear of the oil exhaust filter housing.

When replacing the oil, it is first drained off. The old filter is then screwed off and replaced by one. The pump can now be filled with new oil.

For the correct type of oil filters refer to the list of maintenance parts on page 29.



a new

Oil filter

### Inspect and change oil exhaust filter

There are one or more oil exhaust filters in the pump which absorb and filter oil vapours. The filters will become saturated after a period of time and need to be replaced. This is on average between 12 and 18 months. When the filters are saturated it is no longer possible to achieve maximum vacuum.

#### Filter housing types



016-021 m3/h



040-063-100 m3/h



160-300 m3/h

- Filter housings can be located at the side or behind the machine
- Appearance can vary depending on the model (multiple housings on pump or multiple filters in one housing)

Change oil exhaust filter(s)

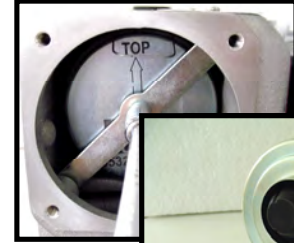

- Place and tension the new filter (take care that the gasket is correctly positioned) in the housing
- Screw the cover back onto the housing
- Screw the back or side plate on the machine

Remove tensioner(s) and filter(s) from the housing

Take care that the filter gasket does not remain behind when removing the filter

- Pumps and housing can have a different appearance but the principle of replacing remains the same.
- Take care that the correct type of filter is used for the pump type, see page 29 for the correct type of filter for the type of pump
- It is advisable to have the supplier do this service.

SEAL SYSTEM MAINTENANCE

All or some of the following sealing systems are possible in the BOXER/MARLIN/FALCON/POLAR series. It is essential to know which sealing system is applicable to the relevant machine.

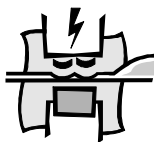

DOUBLE SEAL  
2 x 3,5 mm



CUT-OFF SEAL  
1 x 3,5 mm seal  
1 x 1,1 mm cut



1-2 CUT-OFF SEAL  
1 x 3,5 mm seal  
1 x 1,1 mm cut

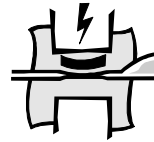

WIDE SEAL  
1 x 8,0 mm

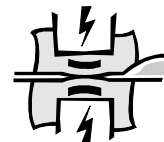

BI-ACTIVE SEAL  
1 x 5,0 mm seal  
above and below

Servicing the sealing bar is almost identical for all systems. The seal quality is partially dependent on the maintenance of the sealing bar and contra-bar (silicone holder). The main maintenance activities are the daily cleaning of the sealing bar and the silicone holder with a damp cloth and a weekly inspection of the bars with replacement of the sealing wire, teflon tape or silicone rubber if irregularities appear on top of the bar or the seal quality is insufficient.

The average maintenance cycle of the sealing bar (teflon tape / sealing wire) is **at least once every 3 months**.  
(This indication refers to regular use of the machine, on average 8 hours per day and packaging standard products with standard vacuum packaging materials. No rights can be derived from this indication)

**Replace sealing wire and teflon tape**

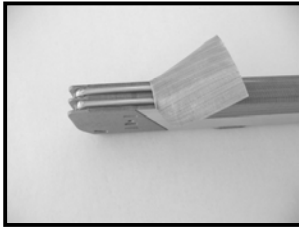

*Remove teflon tape*

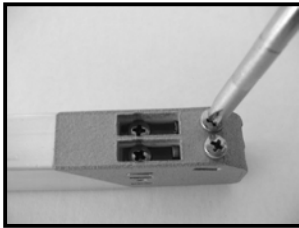

*Unscrew and remove sealing wires*

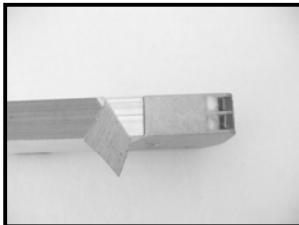

*Replace the teflon tape*

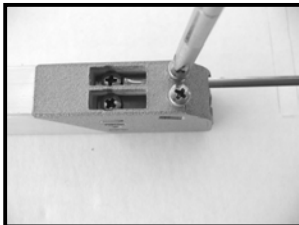

*Screw down new wires onto clamping plate*



*Pull wires taught using a pair of pliers and a vice and screw the wires down on the clamping plate.*

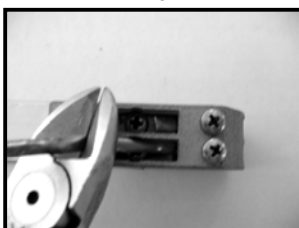

1. Remove the sealing bar(s) from the holders (in the chamber or lid) by releasing the click system or by unscrewing the screws.
2. Remove the teflon tape from the sealing bar.
3. The old sealing wires and cut-off wires (if applicable) can be removed by unscrewing the clamp (see illustration) and pulling the wires from the grooves.
4. Remove the teflon tape that is attached to the top of the sealing bar and stick a new piece of teflon tape to the bar of the same length after having degreased and cleaned the bar with a dust free cloth.
5. Cut a new piece of sealing wire or cut-off wire to the size of the sealing beam plus about 15 cm ( $\pm$  6 inches). If 2 sealing wires or an extra cut-off wire is on the sealing beam then a second sealing wire or cut-off wire must of course be cut.
6. Place the end of the wire or wires through the groove(s) on the side of the sealing beam and screw the wires to the bottom.
7. Place the sealing bar top down in a vice and pull the sealing wire or wires through the other side of the groove(s) on the sealing beam.
8. Pull the wires tight with a pair of pliers and screw them down at the same time. Ensure that the wire (wires) is (are) pulled taught and straight with the help of a pair of pliers before the wires are screwed down.
9. It is handy to use a pair of adjustable pliers as a lever for optimal wire tension. Place one end of the sealing beam in the vice and stretch the wire (wires) by pressing down the bar.
10. Cut off the extruding wire end(s) on both ends after having screwed it tight.
11. Cut a piece of teflon tape as long as the sealing bar plus about 5 cm ( $\pm$  2 inches).
12. Stick the new teflon tape straight over the new sealing wire (wires). Ensure that the teflon is straight on the sealing bar and that the sticky part is stuck on the side. Ensure that the teflon is stuck on the bar smoothly and without folds.
13. Cut the teflon tape off so that the sticky part does not get stuck on the sides of the clamps but that the teflon extends over the top of the clamps.
14. Place the sealing bar back in the machine. Ensure that the sealing beam is properly clicked onto the holders or that the screws are firmly screwed in.

Special remark bi-active sealing system  
 The sealing wire must be accurately placed on the upper and lower beams so that the sealing wires line up with each other exactly during sealing.

See page 30  
 for correct parts and quantities

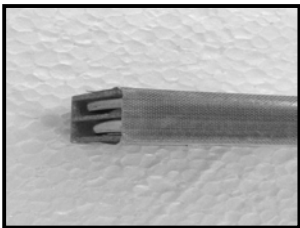

*Cut off the ends of the sealing wire and stick Teflon tape over the sealing beam without folds*

## SILICONE HOLDER AND LID GASKET MAINTENANCE

### Replace the rubber silicone holder

The silicone holder must be inspected weekly for irregularities on the silicone rubber (mainly caused by burning by the sealing wire). If irregularities appear then the silicone rubber must be replaced.

Average maintenance cycle for silicone rubber is **at least once every 6 months**

*(This indication refers to regular use of the machine with standard products. No rights can be derived from this indication)*

1. Remove the old silicone rubber from the holder.
2. Cut a new piece of silicone rubber the same size as the old one. The same size is very important, too short or too long will cause problems with sealing.
3. Place the new piece in the silicone holder. Ensure that the silicone rubber is completely and evenly placed in the groove. It is also important that the surface of the silicone rubber is smooth after it is in place and it shows no signs of tension.



*Appearance may differ per model but principle remains*

### Replace lid gasket

The lid gasket ensures that the vacuum chamber is completely sealed during the machine cycle. This is essential for achieving a maximum vacuum. The lid gasket due to the extreme pressure differences and must be replaced regularly. Inspect gasket weekly for tears or damage.

Average maintenance cycle for lid gasket is **at least once every 6 months**

*(This indication refers to regular use of the machine, on average 8 hours a day and with standard products. No rights can be derived from this indication)*

The length of the new lid gasket is determined by using the old gasket. If the lid is too short or too long it can cause problems closing the lid or leak.

The rubber must be placed evenly and without tension in the holder. The ends must be straight and must be laid tightly against each other to avoid leakage.

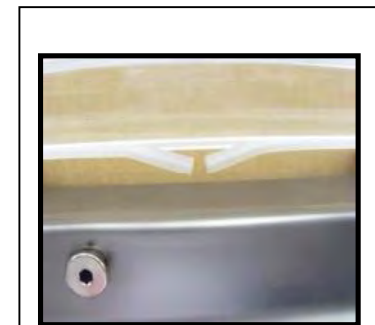

wears the lid

*Ensure that the ends of the lid rubber connect*

rubber

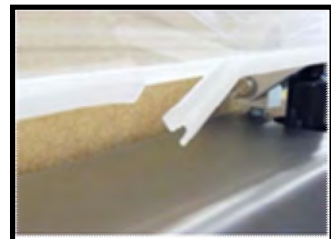

be cut

LIST OF SERVICE PARTS

**VACUUM PUMP PARTS**

BUSCH VACUUM PUMPS	HENKELMAN MODELS
016 m <sup>3</sup> /h	BOXER 35
021 m <sup>3</sup> /h	BOXER 42 / 42 XL / 42 XL BA
040 m <sup>3</sup> /h	MARLIN 46
063 m <sup>3</sup> /h	MARLIN 52 / 90 – FALCON 52 / 2-60 – POLAR 52 / 2-40
100 m <sup>3</sup> /h	FALCON 80 / 2-70 – POLAR 80 / 2-50
160 m <sup>3</sup> /h	POLAR 2-75
300 m <sup>3</sup> /h	POLAR 2-85 / 2-95

BUSCH	STANDARD OIL			OIL FILTER		OIL MIST FILTER		
	Type	Henkelman Reference	Litres	Type	Henkelman Reference	Type	Henkelman Reference	Amount
016 m <sup>3</sup> /h	VG 32	0439510	0.40	-	-	50-60Hz	0939163	1
021 m <sup>3</sup> /h	VG 32	0439510	0.40	-	-	50-60Hz	0939165	1
040 m <sup>3</sup> /h	VG 100	0439520	1.0	040-063-100	0939090	50-60Hz	0939171	1
063 m <sup>3</sup> /h – 50Hz	VG 100	0439520	1.0	040-063-100	0939090	50Hz	0939171	1
063 m <sup>3</sup> /h – 60Hz	VG 100	0439520	2.0	040-063-100	0939090	60Hz	0939170	2
100 m <sup>3</sup> /h	VG 100	0439520	2.0	040-063-100	0939090	50-60Hz	0939170	2
160 m <sup>3</sup> /h	VG 100	0439520	5.0	160-300	0939091	50-60Hz	0939175	2
300 m <sup>3</sup> /h	VG 100	0439520	7.0	160-300	0939091	50-60Hz	0939175	3

**SEAL SYSTEMS**

PARTS	SPECIFICATIONS	HENKELMAN REFERENCE	QUANTITY
Teflon tape	46 mm wide teflon tape	0305515	length sealing bar + 5 cm
Double Seal	2 x 3.5 mm round wire	0305000	2 wires length of sealing bar + 15 cm
Cut-off seal	1 x 3.5 mm round wire	0305000	1 wire length of sealing bar + 15 cm
	1 x 1.1 mm round wire	0305010	1 wire length of sealing bar + 15 cm
1-2 Cut-off seal	1 x 3.5 mm round wire	0305000	1 wire length of sealing bar + 15 cm
	1 x 1.1 mm round wire	0305010	1 wire length of sealing bar + 15 cm
Broad Seal	1 x 8.0 mm flat wire	0305025	1 wire length of sealing bar + 15 cm
Bi-Active Seal	1 x 5.0 mm flat wire	0305020	1 wire length of sealing bar + 15 cm
	1 x 8.0 mm flat wire	0305025	1 wire length of sealing bar + 15 cm
Silicone Rubber	Silicone 17 x 8	0320200	length silicone holder

Bi-active Seal: Single chambers uses 2 x 5,0 mm. Double chambers 1 x 5,0 mm and 1 x 8,0 mm

**LID GASKET**

MODELS	HENKELMAN REFERENCE	LENGTHS PER MODEL (in cm)	
<b>BOXER SERIES</b>	0320215	BOXER 35 BOXER 42 BOXER 42 XL / BOXER 42 XL BA	175 190 210
<b>MARLIN 46 / 52 / 90 FALCON SERIES POLAR 52 / 80 / 2-40 / 2-50</b>	0320210	MARLIN 46 MARLIN 52 / FALCON 52 / POLAR 52 MARLIN 90 FALCON 80 / POLAR 80 FALCON 2-60 / 2-70 POLAR 2-40 / 2-50	255 250 290 300 260 / 300 280 / 300
<b>POLAR 2-75 / 2-85 / 2-95</b>	0320212	POLAR 2-75 / 2-85 / 2-95	350 / 390 / 440

*Lengths specified are always a little longer and must be cut to the correct length.*

## TECHNICAL SPECIFICATIONS

MODEL	VACUUM CHAMBER WORKING PLATE	LID	HOUSING	DIMENSIONS (mm)	PUMP (m <sup>3</sup> /h)	FINAL VACUUM (%)
<b>BOXER SERIES</b>						
35	Stainless steel	Transparent	Stainless steel	450x525x385	016	99,80%
42	Stainless steel	Transparent	Stainless steel	490x525x430	021	99,80%
42 XL	Stainless steel	Transparent	Stainless steel	490x610x445	021	99,80%
42 XL Bi-active	Stainless steel	Transparent	Stainless steel	490x610x420	021	99,80%
<b>MARLIN SERIES</b>						
46	Stainless steel	Transparent	Stainless steel	780x660x970	040	99,98%
52	Stainless steel	Transparent	Stainless steel	700x690x1030	063	99,98%
90	Stainless steel	Transparent	Stainless steel	1065x480x960	063	99,98%
<b>FALCON SERIES</b>						
52	Aluminium	Aluminium/Sight glass	Stainless steel	700x690x1070	063	99,98%
80	Aluminium	Aluminium/Sight glass	Stainless steel	900x820x1070	100	99,98%
2-60	Aluminium	Aluminium/Sight glass	Stainless steel	1060x880x1070	063	99,98%
2-70	Aluminium	Aluminium/Sight glass	Stainless steel	1260x1010x1070	100	99,98%
<b>POLAR SERIES</b>						
52	Stainless steel	Stainless steel	Stainless steel	700x730x1100	063	99,98%
80	Stainless steel	Stainless steel	Stainless steel	920x790x1125	100	99,98%
2-40	Stainless steel	Stainless steel	Stainless steel	1480x790x1090	063	99,98%
2-50	Stainless steel	Stainless steel	Stainless steel	1480x970x1120	100	99,98%
2-75	Stainless steel	Stainless steel	Stainless steel	1545x1150x1150	160	99,99%
2-85	Stainless steel	Stainless steel	Stainless steel	1900x1300x1150	300	99,99%
2-95	Stainless steel	Stainless steel	Stainless steel	2420x1210x1130	300	99,99%

Specifications can deviate from optional models

Standard ambient temperature	05 °C – 30 °C
For deviating ambient temperatures	see page 24 for special oil specifications
Maximum use per day	BOXER series 5 hours per day Other machines: 8 hours per day
Electricity	Voltage: see machine tag Frequency: see machine tag Power: see machine tag
Electrical connection	Maximum fluctuation $\pm$ 10% of the official registered voltage
Gas bottle connector diameter (if applicable)	BOXER series diameter 6 mm POLAR 2-85 / 2-95: diameter 13 mm OTHER MODELS: diameter 8 mm
Maximum pressure gas bottle connector (if applicable)	1 ATO
External seal pressure connection (if applicable)	diameter 6 mm
Sound level	< 70 DB



# ELECTRICAL DIAGRAMS

## Control Current Diagram BOXER/ TOUCAN series

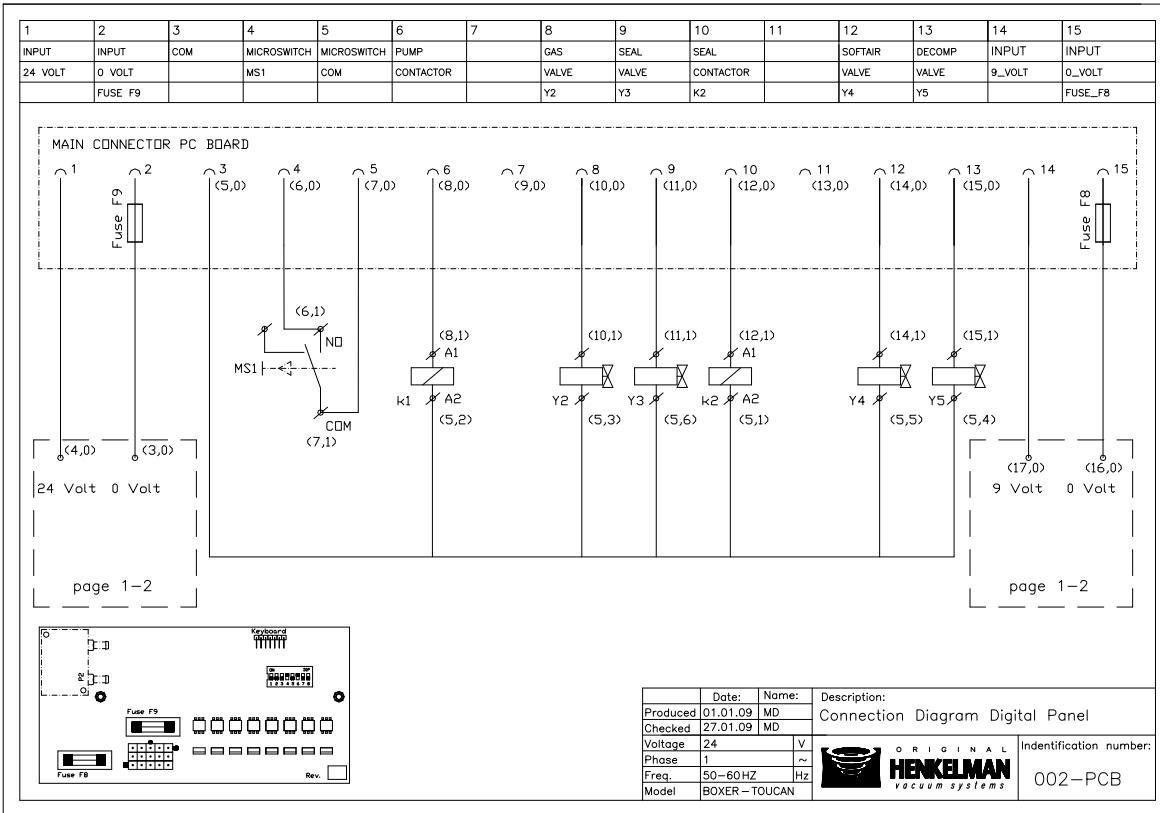

## Power Circuit Diagram BOXER/ TOUCAN series

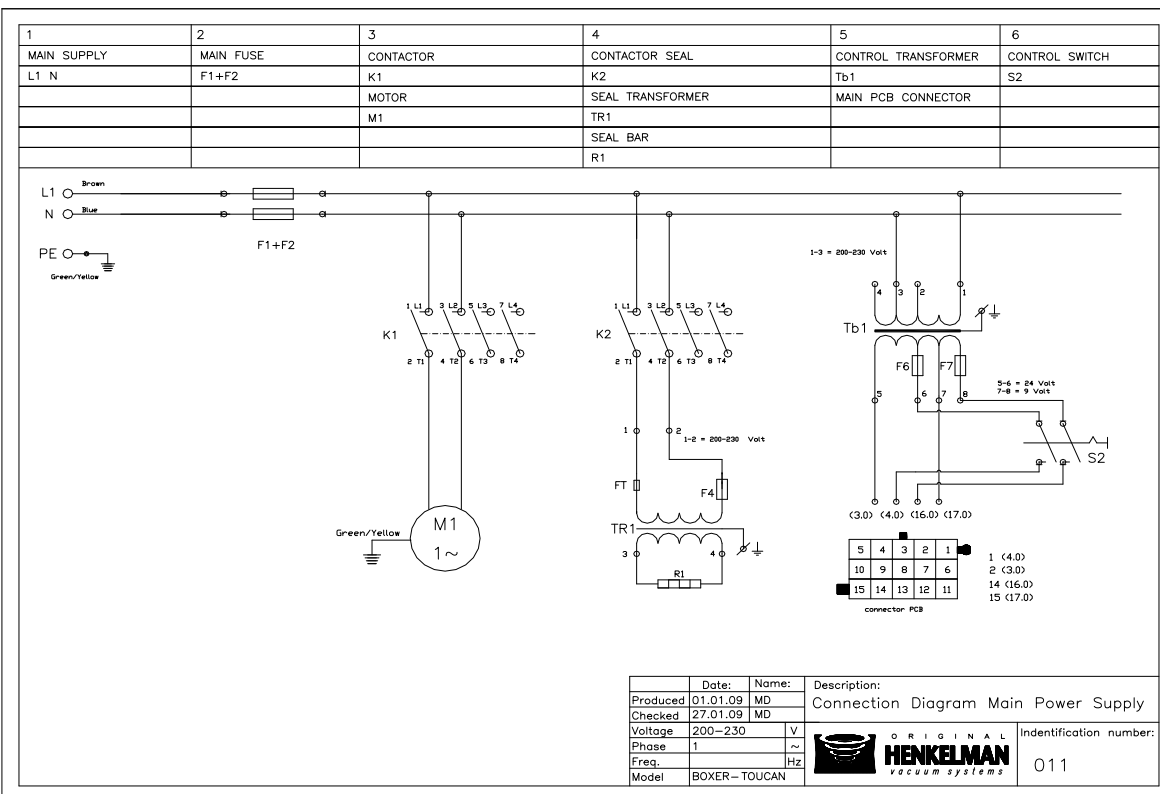

Diagrams are shown for standard configurations.

**Control Current Diagram MARLIN 46/52/90 / FALCON 52/80 / POLAR 52/80**

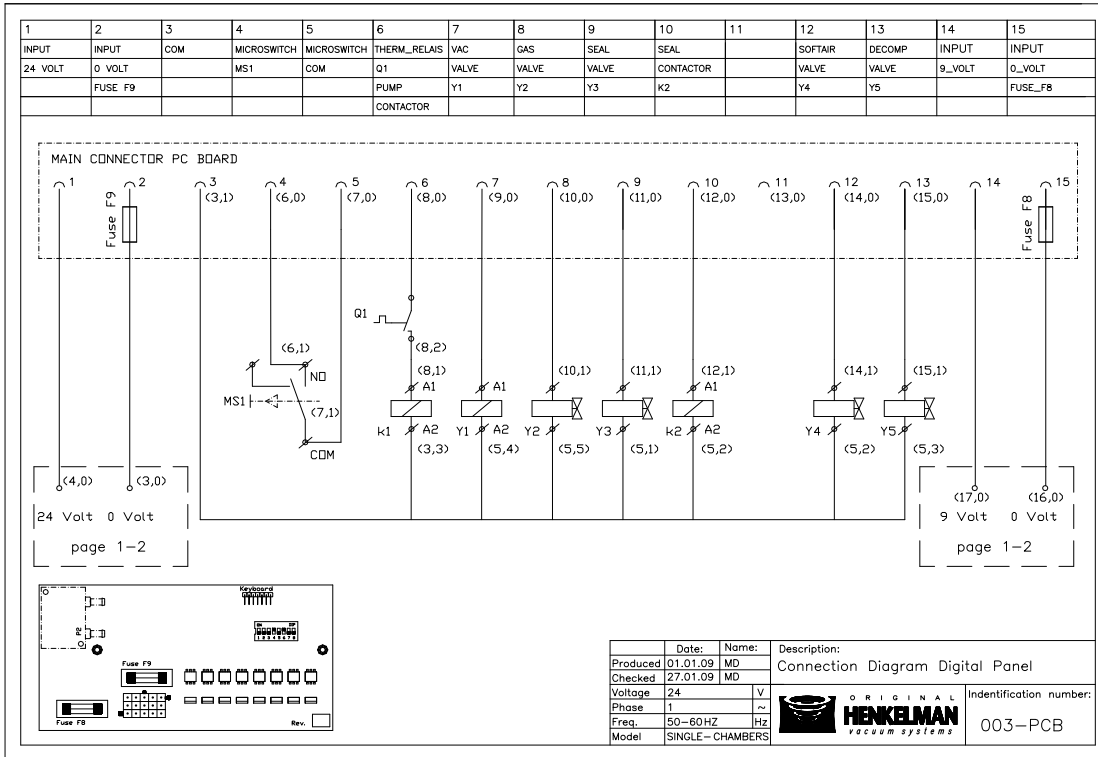

Diagrams are shown for standard configurations.

**Control Current Diagram FALCON 2-60/2-70 / POLAR 2-40/2-50/2-75/2-85/2-95**

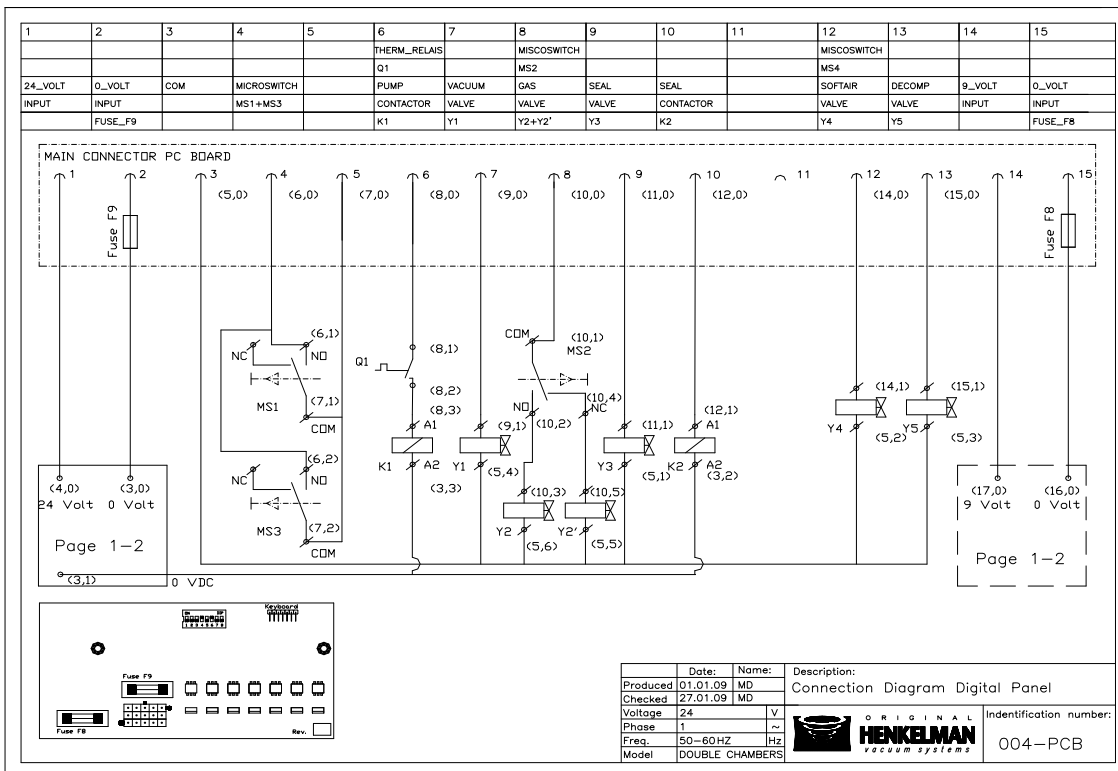

**Main Circuit Diagram MARLIN 46-52-90/FALCON 2-60/2-70 / POLAR 2-40/2-50/2-75/2-85/2-95**

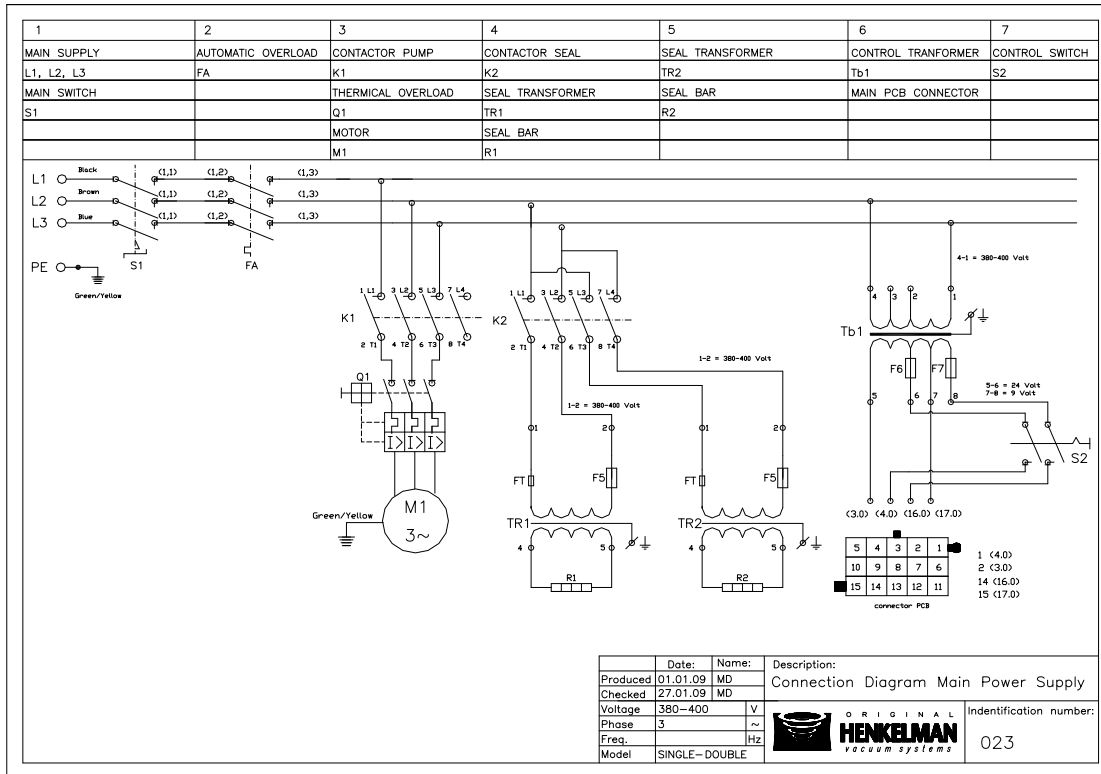

Diagrams are shown for standard configurations.

List of fuses

- Fuses are located where the power enters the component board
- Fuses are located on transformers (control and seal)
- Two fuses are placed on the control circuit.

Due to different mains voltages and machine models there is a variety of fuse types that can be present in the machine. Refer to the specifications of the relevant component for the correct types and values of fuses for replacement, or contact your supplier.



Caution, to avoid fire and/or other irreparable damage to the machine, replacement fuses must always be of the same type with the same value as the fuses being replaced!!

Voltage



Caution, the maximum allowable voltage fluctuation is ± 10% of the official voltage stated on the machine tag.

---

## ERROR CODES

---

The controls are programmed with a number of error codes. These error codes are intended to give the user / dealer a clear indication of what the possible cause might be why starting or packaging is not working as expected.

F1: This code indicates that the cycle (cover switch) will be interrupted prematurely.

Example: the cover of the machine closes after starting, but before sufficient vacuum is present to keep the cover closed the operator lets go of the cover. The F1 code will now be shown on the display.

In a time-controlled machine, the time for gassing is set in such a way that the entire chamber is gassed and the cover opened without sealing taking place. Here too the F1 code will immediately be shown on the display.

This message will never be shown directly after the controls are started, but during the course of the cycle.

F2: This code indicates that the sensor is not working properly.

When the controls are started, the condition of the sensor is checked. If the feedback data of the sensor are not correct, F2 is shown on the display. This message will be shown directly after the sensor controls are started.

RP-: This message will be shown when, due to circumstances, the controls are unable to retrieve the programme values.

The word 'circumstances' means peak tensions or a tension drop during starting. When such a situation occurs, the print will start with this message and go no further. Two options exist now: the machine can be switched off and on again to see if the problem repeats itself or the reprog key can be pressed. By operating the reprog key, the controls will use the factory settings to start. The programme values set by the client will be cancelled as a result.

This message will be shown directly after the controls are started.

If one or more of the above messages occur regularly, we advise you to contact your supplier.

# PNEUMATIC DIAGRAMS

## BOXER series / MARLIN series

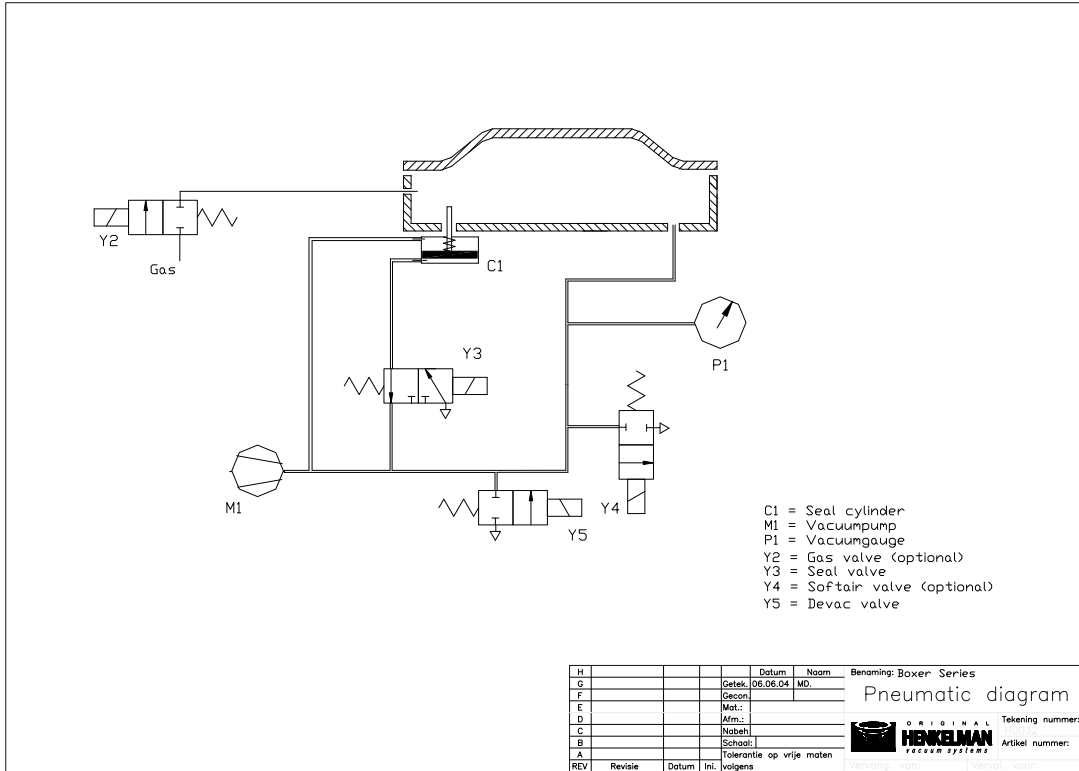

## FALCON series / POLAR series

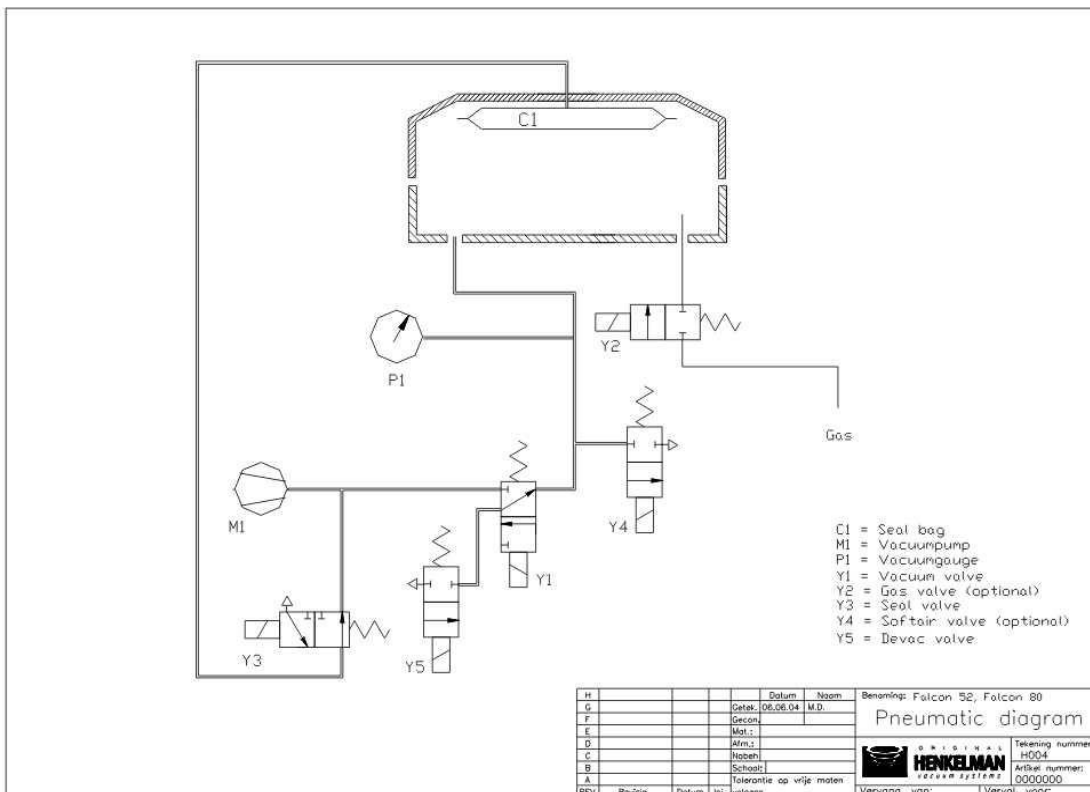

Diagrams are shown for standard configurations.

## PROBLEM SOLVING

PROBLEM	CAUSE	SOLUTION
<b>Machine does not work</b>	<ul style="list-style-type: none"> <li>• The plug is not plugged into the wall socket.</li> <li>• The main fuse is burnt.</li> <li>• The circuit board fuse is burnt.</li> </ul>	<ul style="list-style-type: none"> <li>• Plug the plug into the wall socket.</li> <li>• Replace the fuse (Ensure the correct value).</li> <li>• Disassemble the front panel and replace the fuse.</li> </ul>
<b>Machine does not work Control panel is on</b>	<ul style="list-style-type: none"> <li>• The control transformer fuse is burnt.</li> <li>• The micro switch which is activated when the lid is closed needs adjustment or is faulty.</li> <li>• There is an internal malfunction.</li> </ul>	<ul style="list-style-type: none"> <li>• Check this and if necessary replace it.</li> <li>• The micro switch must be properly adjusted or replaced</li> <li>• Consult supplier.</li> </ul>
<b>Transparent lid does not open automatically</b>	<ul style="list-style-type: none"> <li>• The gas spring is faulty</li> </ul>	<ul style="list-style-type: none"> <li>• Consult the supplier.</li> </ul>
<b>Final vacuum is insufficient</b>	<ul style="list-style-type: none"> <li>• The set vacuum time is too short.</li> <li>• There is too little oil in the vacuum pump.</li> <li>• The extraction hole at the back of the vacuum chamber is partially covered by the vacuum bag during vacuuming.</li> <li>• The lid gasket is worn.</li> <li>• The oil is contaminated.</li> <li>• The oil exhaust filter is saturated.</li> </ul>	<ul style="list-style-type: none"> <li>• Extend the vacuum time.</li> <li>• Check the oil level and fill up if necessary (Note the type and quantity).</li> <li>• Place the vacuum bag closer to the sealing bar.</li> <li>• Replace the lid gasket.</li> <li>• Replace the oil (Note the type &amp; amount).</li> <li>• Replace the oil exhaust filter / Consult the supplier.</li> </ul>
<b>The machine builds up a vacuum slowly</b>	<ul style="list-style-type: none"> <li>• The pump's extraction filter is blocked.</li> <li>• The oil exhaust filter is saturated.</li> </ul>	<ul style="list-style-type: none"> <li>• Consult the supplier.</li> <li>• Replace the oil exhaust filter / Consult the supplier.</li> </ul>

PROBLEM	CAUSE	SOLUTION
<p><b>The vacuum bag is not properly and/or correctly sealed.</b></p>	<ul style="list-style-type: none"> <li>• The vacuum bag is being placed correctly on the sealing bar.</li> <li>• The sealing time is too long or too short.</li> <li>• The silicone rubber in on the silicone holder is damaged or worn.</li> <li>• The teflon tape is damaged.</li> <li>• The inside of the vacuum bag opening is contaminated.</li> <li>• There is too much gas in the package.</li> </ul>	<ul style="list-style-type: none"> <li>• Place the vacuum bag neatly and smoothly on the sealing bar. Ensure that the opening of the bag is always within the vacuum chamber.</li> <li>• Adjust the sealing time longer or shorter.</li> <li>• Replace the silicone rubber.</li> <li>• Replace the teflon tape</li> <li>• Clean the vacuum bag's opening.</li> <li>• Check this by setting the gas function to the OFF position.</li> </ul>
<p><b>The amount of gas in the vacuum bag is insufficient (optional).</b></p>	<ul style="list-style-type: none"> <li>• The gas bottle is empty or nearly empty.</li> <li>• The gas bottle is still closed.</li> <li>• Gas flush time is too long or too short.</li> <li>• The gas flush pressure is incorrectly set.</li> </ul>	<ul style="list-style-type: none"> <li>• Replace the gas bottle.</li> <li>• Check if the valve on the gas bottle is closed. If so, open it.</li> <li>• Shorten or extend the gas flush time.</li> <li>• Check if the manometer or the secondary pressure of the gas is set to 1 atmosphere (1-ATO).</li> </ul> <p><b>WARNING!</b> The pressure of the gas mixture may never be more than 1 atmosphere/ATO.</p>

*In the case of other problems or questions contact the supplier or Henkelman BV.*

## DIGITAL TIME CONTROL FACTORY SETTINGS

Program	0**	1	2	3	4	5	6	7	8	9
Vacuum time	30	25	20	15	10	30	25	20	20	15
Gas flush time*	OFF	OFF	OFF	OFF	OFF	5	5	10	15	15
Sealing time	2.5	2.5	2.5	2.5	2.5	2.5	2.5	2.5	2.5	2.5
Soft-air time*	3	3	2	2	2	OFF	OFF	2	OFF	OFF

- \* Only applicable if the machine is equipped with the options in question.  
If the machine is not equipped with the gas flush system and/or soft air ventilation then these options will not be available on the control panel.
- \*\* Program 0 cannot be modified

## DIGITAL SENSOR CONTROL FACTORY SETTINGS

Program	0**	1	2	3	4	5	6	7	8	9
Final vacuum pressure %	99	90	99	99	99	80	90	50	90	60
Vacuum plus time	15	OFF	15	10	10	OFF	OFF	OFF	OFF	OFF
Final vacuum pressure % after gas flush*	OFF	OFF	80	70	60	50	80	OFF	80	30
Sealing time	2.5	2.5	2.5	2.5	2.5	2.5	2.5	2.5	2.5	2.5
Soft-air time*	3	3	2	2	2	OFF	OFF	2	OFF	OFF

- \* Only applicable if the machine is equipped with the options in question.  
If the machine is not equipped with the gassing system and/or soft air ventilating then these options will not be available on the operating panel.
- \*\* Program 0 cannot be modified

## CUSTOMER SETTINGS TO BE FILLED IN

Program	0	1	2	3	4	5	6	7	8	9
Vacuum time Final vacuum pressure %	99									
Vacuum plus time	15									
Gas flush time* Final vacuum pressure % after gassing*	OFF									
Sealing time*	2.5									
Soft-air time*	3									



## REMARKS ON SPECIAL APPLICATIONS

### *MACHINE WITH GAS FLUSH SYSTEM (if applicable)*

If the machine is equipped with the gassing system then the following remarks are important :

**NEVER USE GAS MIXTURES WITH MORE THAN 20% OXYGEN AND OR OTHER EXPLOSIVE GASSES. THIS COULD CAUSE FATAL EXPLOSIONS.**

**NEVER USE SEPARATE GAS BOTTLES WITH A MIXER WHEREBY ONE OF THE BOTTLES IS ONLY FILLED WITH OXYGEN. MALFUNCTIONING OF THE MIXER OR IF THE OTHER BOTTLE WERE TO BE EMPTY COULD CAUSE FATAL EXPLOSIONS.**

All guarantees and/or liability expire in the case of accidents and/or damage caused by using oxygen or other explosive gasses.

The maximum gas pressure that can be set in the packaging is 35% (-0.35 bar on the vacuum meter). This means that there is 65% gas and 35% vacuum (under pressure) in the packaging. If a higher gas pressure results in insufficient seal quality contact the supplier or Henkelman BV for more information about connecting external seal pressure.

Henkelman recommends checking the pressure and amount of gas in the gas bottles regularly. Ensure that the gas bottle(s) is(are) correctly anchored. Always turn off the main cock on the gas bottle if the machine is not in operation or if the gas flush function is not active.

### *PACKAGING LIQUID PRODUCTS*

The machines can be also used for packaging liquid products like soups or sauces. In this process the vacuum process must be carefully monitored (only possible with transparent lid or lid with inspection window). The [STOP VACUUM] key must be pressed as soon as bubbles appear in the product; the saturation point (same as boiling point) has then been reached.

Settings for programs for packaging liquid products can best be programmed using automatic programming (see page 19-20).

The saturation point of liquids is reached at a certain ratio line of low pressures and high temperatures (see the example table for water below). The saturation point will be reached sooner in the vacuum process when packaging liquids with a high temperature (the amount of vacuum will therefore be less).

Henkelman recommends therefore to first cool liquid products before packaging. In this way an optimal vacuum of the product can be achieved.

Saturation point of water – relation between the pressure and temperature of the water

<b>Vacuum pressure [mbar]</b>	1000	800	600	400	200	100	50	20	10	5	2
<b>Boiling Point Temperature [°C]</b>	100	94	86	76	60	45	33	18	7	-2	-13

A handy tip when packaging liquid products is to use a liquid insert plate so that the product remains at the bottom of the packaging during the vacuuming process and there is less risk of liquid splashing out of the packaging. Contact the supplier or Henkelman BV for more information about the liquid insert plate.

## EXTERNAL VACUUMING OF FOOD CONTAINERS (if applicable)

The BOXER and MARLIN series can be equipped with an option for externally vacuuming special food containers. This system can vacuum special containers for longer storage life of the (food) products in the dish. The container has a special lid with valve. Contact the supplier or Henkelman BV for more information about the containers. The system for the machine consists of a hose with vacuum applicator.

### Operation External Vacuuming Food Containers

1. Start the machine
2. Place the hose connector over the extraction opening of the vacuum chamber of the machine

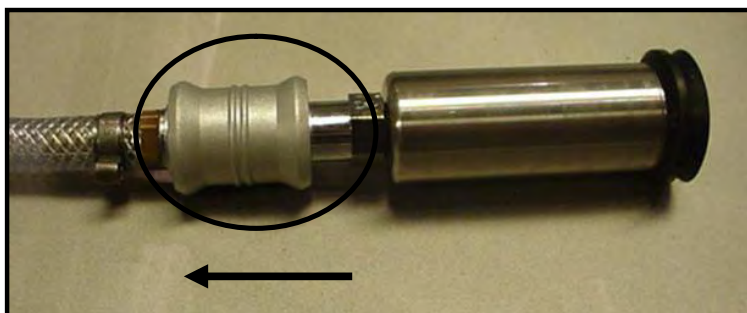

3. Check that the sliding valve on the vacuum applicator is on the side of the hose (closed position).



4. Press the PROG 0-9 Key until [E] (External Vacuuming) appears on the small display.

5. Place the vacuum applicator over the valve of the container and slide the sliding valve towards the lid to open the valve.



6. Press the + Key. The vacuum pump starts to run and the container is vacuumed.

7. When the vacuum meter reaches -1 then the container is fully vacuumed.



8. Press the - Key to stop the vacuum pump

9. The vacuum applicator can now be removed from the lid by sliding back the sliding valve.
10. The container is now ready for storage and/or stock.
11. If the machine needs to be used for normal applications then the hose can be removed from the extraction opening and the required program chosen using the PROG 0-9 Key.

---

## EEC DECLARATION OF CONFIRMITY

---

### Concept of an EEC Declaration of Conformity

Henkelman B.V.  
Titaniumlaan 10  
5221 CK 's-Hertogenbosch  
Netherlands

Declare that the machine complies  
with the machine directive 2006/42/EC, the low voltage  
directive 2006/95/EEG and the EMC-directive  
2004/108/EG.

Machine-Type:  
Machine number:  
Year of construction of the machine:

The machine and the belonging documentation is in accordance  
with the following standards or other normative documents.

NEN-EN 60204-1, NEN-EN IEC 61558-1,  
NEN/ EN IEC 61558-2-6  
NEN 5509, NEN-EN –ISO 12100-1  
NEN-EN-ISO 12100-2, NEN-EN-ISO 13732-1,  
NEN-EN-ISO 13857, RoHS 2002-95-EG

If modifications are made to this machine without written  
permission, these modifications fall entirely outside our  
responsibility and this declaration will be considered  
dissolved.

's-Hertogenbosch,  
S.C.H. Fliervoet-Maas

---

## MAINTENANCE SCHEDULE / NOTES

---

Date	Company	Operations/ Maintenance	Remarks

## REMOVAL TOOLS FRONT PANEL

With every machine we enclose two special tools to remove the front panel. You can slide the tools into the slots at the bottom side of the front panel. Lift them a little and pull them towards you.

