



## The Quiet One<sup>®</sup>

### Blending Station

ALL MODELS

## Use and Care Manual

Read and save these instructions

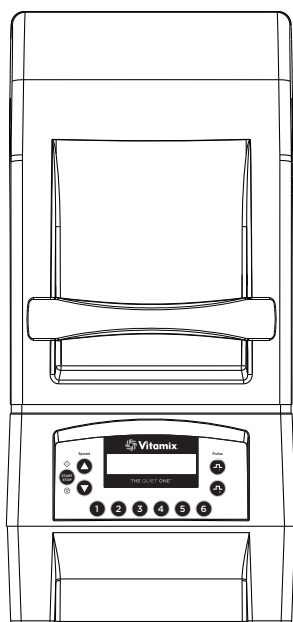

**ON-COUNTER**

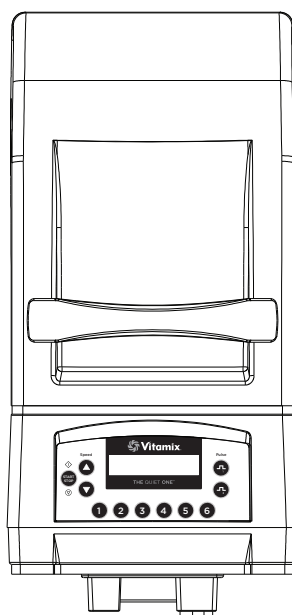

**IN-COUNTER**

ENGLISH

ESPAÑOL

FRANÇAIS

# CONTENTS

<b>English</b> .....	<b>1</b>
<b>Español</b> .....	<b>29</b>
<b>Français</b> .....	<b>57</b>
<b>Important Safeguards</b> .....	<b>4</b>
<b>General Instructions</b> .....	<b>6</b>
<b>Control Panel</b> .....	<b>8</b>
<b>Programming</b> .....	<b>10</b>
Programming Pre-Set Buttons	
Programming Custom Chip	
Resetting Pre-Set Buttons	
Recipe Options	
<b>Machine Assembly</b> .....	<b>14</b>
Compact Cover	
Lid	
Blade Assembly	
<b>Installation</b> .....	<b>18</b>
<b>Caring for your Machine</b> .....	<b>20</b>
<b>Troubleshooting</b> .....	<b>22</b>
<b>Warranty</b> .....	<b>24</b>
<b>Parts List</b> .....	<b>26</b>
<b>Product Specifications</b> .....	<b>28</b>

# IMPORTANT SAFEGUARDS

1. Read all instructions.
2. To protect against risk of electrical shock, do not put motor base in water or other liquid.
3. Close adult supervision is necessary when machine is used by or near children.
4. Unplug the power cord from the wall outlet when the Vitamix® machine is not in use, before disassembling, when putting on or taking off parts, and before cleaning, other than washing the container.
5. Never come in contact with moving parts, especially the blades.
6. Do not operate any machine that malfunctions, has a damaged cord or plug, has been dropped or is damaged in any manner. If you purchased your equipment in the U.S.A., call **Vitamix Technical Support, 800-886-5235** for examination, repair, possible replacement, or electrical or mechanical adjustment. If you purchased outside of the U.S.A., please contact your local authorized Vitamix Distributor, or contact the Vitamix International Division at +1.440.782.2450 or email: [international@vitamix.com](mailto:international@vitamix.com) for a distributor near you.
7. Do not use attachments not recommended or sold by Vitamix. Doing so will void the warranty. **Alteration or modification of this product in any form is not recommended as such may result in bodily injury.**
8. **Do not use outdoors.**
9. Do not let the power cord touch hot surfaces or hang over edge of table or counter.
10. Do not place the machine on or near a hot gas or electrical burner, in a heated oven, or allow machine to touch hot surfaces. External heat sources can damage the machine.
11. Keep hands and utensils out of container while motor is running to prevent the possibility of severe personal injury and/or damage to the Vitamix machine. A rubber spatula may be used, but only when the Vitamix machine is not running.
12. **WARNING: Blades are sharp. Handle carefully.**
  - Never try to remove the blades while container is sitting on the motor base.
  - Do not operate with loose, nicked or damaged blades – replace immediately.
  - To reduce the risk of personal injury, never place blade assembly on motor base without the Vitamix container properly attached.
13. The maximum capacity is equivalent to the ounces (liters) listed on the container, i.e., 48 oz. / 1,4 L, and is substantially less with thick mixtures.
14. **Always operate the Vitamix machine with the lid in place and securely attached.**
15. Display window area will scratch when contacted with a scouring pad or sharp object. Use a soft cloth to wipe the control panel area clean.
16. The machine cannot be cleaned with a water jet.
17. It is recommended that for a 120 V installation, you have at least one 20 amp outlet per machine, available within 6 ft. / 1,8 m of the Vitamix. 220 V and 100 V units require a dedicated line. **Consult an electrician for proper electrical needs.**
18. **CAUTION:** Turn power off or unplug the machine before touching movable parts. Shut off power switch at night or whenever machine will be left unattended.

## Save These Safety Instructions

- The Vitamix blender's U.S.A. power cord comes equipped with a three-prong (grounding) plug which mates with a standard three-prong wall outlet (Figure A). **This cord will vary for countries outside the United States of America.**
- Adapters (Figure B) are available for two-prong outlets. Do not cut or remove the third (ground) prong from the plug or power cord.
- Consult your electrician if you are not sure if the wall outlet is grounded through the building wiring. With a properly grounded two-prong wall outlet, ground the machine by attaching the tab on the adapter to the wall outlet cover by means of the screw in the center of the cover (Figure B).



### WARNINGS!

Three-prong adapters are not to be used in Canada.

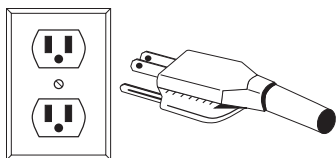

**FIGURE A**

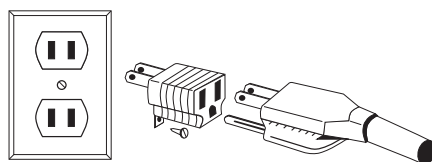

**FIGURE B**

### IMPORTANT NOTES!

The instructions appearing in this Use and Care Manual cannot cover every possible condition and situation that may occur. Common sense and caution must be practiced when operating and maintaining any appliance.

# GENERAL INSTRUCTIONS

## Instructions for using the Pre-Set Program Buttons

The following is the basic settings of the six Pre-Set buttons for The Quiet One®. These programs, numbered 1 through 6, are blending cycles designed for the most commonly made drinks. Depending on the viscosity of the drink you are creating, selecting one of the Pre-Set programs will run the machine for a full cycle. The machine will stop by itself when the cycle is complete. A cycle varies in speed and length. Your machine's Pre-Set options may differ due to program revisions or due to the difference of recipes, your results may also vary.

**BUTTON 1: General Purpose / Smoothie** – blends smoothies and thin drinks consisting of juice and ice to a creamy consistency. (:18)

**BUTTON 2: Double Smoothie** – blends similar drinks to that of button 1 but at larger volumes. (:18)

**BUTTON 3: Frozen Coffee and Juices** – blends light coffee drinks to a creamy consistency. (:18)

**BUTTON 4: Ice Cream Drinks** – blends drinks containing hard ice cream to a thick shake consistency. (:28)

**BUTTON 5: Double and hard-to-blend ice cream drinks.** (:20)

**BUTTON 6: Thick Hard-to-blend Smoothie** – blends thick frozen fruit & hard ingredients for a thick but consistent smoothie. (:28)

## Blending Tips

1. Place liquids and soft foods in the container first, solid items and ice last. Although not necessary for processing, you may want to cut or break food into smaller pieces for more precise measuring of ingredients. Thawed or partially thawed fruit is recommended.
2. As a general rule, compared to other blenders, you do not need as much ice to make an equally frozen drink in The Quiet One®. If your recipe freezes up, try reducing the amount of ice.
3. Set the container on the motor base by aligning it over the centering pad anchored to the base. **(Motor must be completely stopped before positioning container.)** Containers are not to be used for hard, dry materials. Avoid running your machine with the container empty.
4. Always use a lid that is securely attached when blending.
5. Plug the machine into the nearest outlet (if unplugged). Press the On/Off switch to on. Select desired programmed setting by pressing any of the Pre-Set buttons 1 through 6. The machine will immediately begin to cycle through the selected program and turn off when the program is complete. **(NOTE: Each button has a different pre-selected combination of speed and length for blending.)**

6. Once one of the six Pre-Set program buttons is pushed, the machine will start and stop automatically. By pressing another Pre-Set button, the machine will stop the blending cycle.
7. When the cycle is complete, the blender stops. **Wait until blades come to a complete stop before removing the lid and/or container from the motor base.**
8. Remove the container, pour, garnish and serve the drink.
9. Press the On/Off power switch to off when not in use.

## Maintenance Tips

- **Never bang the container against a surface to loosen the ingredients.**  
Remove the container from the base and use a rubber spatula to remove thick mixtures from the bottom of your container.
- **Never shake or rattle a container while in use.**
- **Never remove the container before the machine has come to a complete stop.**
- **Never start the motor before the container is in place.**



## WARNINGS!

- Turn power off or unplug the machine before touching movable parts. Shut off power switch at night or whenever machine will be left unattended.
- If you detect a change in the sound of the machine or if a hard or foreign object comes into contact with the blades, do not serve the drink. Inspect your blade assembly for loose, nicked or missing parts. If parts are loose, missing, or nicked, replace with new blade assembly. (See page 17.)

## IMPORTANT NOTES!

- Check your blades daily for loose, nicked or missing parts. If you find something is loose, nicked or missing, replace the blade assembly before use (see page 17). Do not tighten hex-headed screw (on top of blade assembly). If loose, replace blade assembly immediately.
- The instructions appearing in this Use and Care Manual cannot cover every possible condition and situation that may occur. Common sense and caution must be practiced when operating and maintaining any appliance.
- On all units, the built-in thermal protector keeps track of how hot the motor gets and will warn the user and eventually shut down the motor if the motor is overheating. When overheated, the display will instruct the user to remove the container and run the machine until cool. This takes about two minutes. See page 23, “Cooling the Motor,” for complete instructions. When the thermal protector shuts the motor off, review your processing techniques and your instructions. Your recipes may be too thick or have too much material in them. Consider adding more liquid and consult Vitamix® Customer Service or your local Vitamix Distributor for further assistance.

## CONTROL PANEL

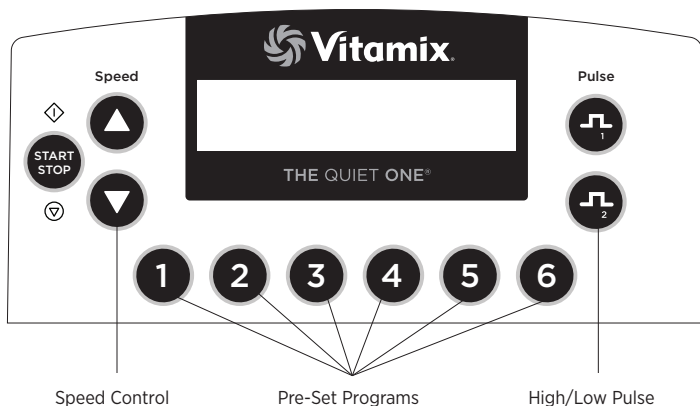

**On/Off Power Switch:** Located on the back of the motor base, the On/Off switch controls the power to the machine. While plugged in, switch to on to ready the machine for blending. Shut off the power switch at night or whenever the machine will be left unattended.

**Start/Stop Button:** Pressing Start (◇)/Stop (▽) once starts and runs the machine and turns the blade. Press Start/Stop button again to stop the machine and the blade.

**Speed Buttons:** Press the ▲ button to gradually increase the speed of the blade in increments of 1%, up to 100%. Press the ▼ button to gradually decrease the speed of the blade in increments of 1%, down to 7%. Speed is used to set the blending speed of the Pulse buttons (see Instructions, page 9) and the Start/Stop button.

**Pre-Set Program Buttons:** These buttons, numbered 1 through 6, are pre-programmed blending cycles designed for the most commonly made drinks. Depending on the viscosity of the drink you are creating, pressing one of the six Pre-Set program buttons will run the machine for a full cycle. The machine will stop by itself when the cycle is complete. A cycle varies in speed and length; see the Instructions on page 6 for a complete description of the range of each Pre-Set button. Each button can be reprogrammed to any recipe through custom programming or by reprogramming to any of the 34 available recipes. See page 10 for instructions on creating custom programming. Due to difference of recipes, your results may vary.

### IMPORTANT NOTES!

**Start/Stop Button:** Pressing one of the Pre-Set program buttons, while the motor is running, will stop the machine.

**Speed Button:** These settings will reset if the power is shut off.

**Display Window:** This area, depending on which button is pressed, displays a variety of operation messages. A “Ready” message appears when there is power to the machine.

**Owner Controls:** The owner control panel is accessible by activating the Power Switch located on the back of the motor base while depressing button 2.

VITA-MIX CORP  
VERSION #201

TEMP	COUNT	TOTAL
NORM	25	100

TIMER	HR:	MIN:	SS
	0:	10:	33

VITA-MIX ADVANCE  
PROGRAM #201

1 TO OVERWRITE  
CURRENT PROGRAM

- Once the unit powers up, the display will cycle through three screens. The first indicates the current program version. The second indicates which program is running on the machine. The third will indicate the motor temperature (NORM, WARM, HOT), and the total hours of operation, including production and testing. This time can not be cleared. Once this screen is reached, button 2 can be released.
- Depress button 2 within 12 seconds to scroll through the menu settings.
- The first press will reveal the timer. Total operation is recorded in hours, minutes and seconds; including production and testing. This time cannot be cleared.
- The second press will reveal the name of the program controlling the Pre-Set buttons. If you are using the Advance® settings, this will read “VITA-MIX ADVANCE PROGRAM.”
- The third press will reveal an option to reset the Pre-Set buttons to the original factory settings.

**Pulse Buttons:** The pulse provides a quick increase or decrease in speed of the blade when blending or refreshing a drink. Press  $\uparrow$  to increase the motor to speeds that range from 51%-100%. Press  $\downarrow$  to decrease the motor speed down to a range of 50%-7%. The Pulse button will override the running program as long as it is depressed. Once released, the original program continues its cycle.

- The Pulse High (  $\uparrow$  ) and Low (  $\downarrow$  ) speed is set by using the Speed buttons. To set, while pressing and holding a Pulse button, press the Speed  $\blacktriangle$  or  $\blacktriangledown$  button until the desired motor speed is reached. The pulse speed will remain at this setting until changed again with the Speed buttons.



# PROGRAMMING

The Quiet One® is pre-programmed with an Advance® program which is optimized for the Advance® container. The program can be customized by using the control panel, or a programming chip or programmer software kit available from Vitamix®. Call your distributor or customer service for more information.

## Programming Pre-Set Buttons

1. Access the 34 stored programs by activating the power switch located on the back of the motor base while depressing the High Pulse button. The display will say “BUTTON SET UP”
2. Press the Speed ▲ or ▼ buttons to scroll through the “Recipe” numbers until you reach the one you want. (For a description of each recipe, see page 12.)
3. Press the Pre-Set button that you want to program for the recipe selected.

BUTTON SET UP  
RECIPE 1

BUTTON SET UP  
RECIPE 17

BUTTON SET UP  
RECIPE 17----->1

READY

### For Example: If you wanted to program button 1 with recipe #17:

1. After accessing the stored programs as described in step 1, the display window will say “BUTTON SETUP.”
2. Press the Speed ▲ button until the screen displays “Recipe 17.”
3. Press the 1 button to apply Recipe 17.
4. Either continue programming the other five buttons or press the High Pulse button to exit and continue blending.

## Programming your Machine with a Custom Chip

1. Turn on the machine.
2. Remove the container and rotate the machine to the rear so that you can see the programming port.
3. With the rear of the machine facing towards you, insert the custom programmed chip (with the words, “THIS SIDE FACING TO THE FRONT OF THE MACHINE” toward the left) into the port located on the right hand side of the machine opposite the On/Off switch. Push gently until chip engages into the port. The display window will read “NEW MODULE.”
4. Within 10 seconds, the six Pre-Set buttons will be re-programmed and the display window will read “Saved” then “Ready.”
5. Remove the programming chip, return it to the original package and store in a safe, easily accessible spot.
6. Press one of the six Pre-Set buttons to reveal, in the display window, the name of the program/drink.

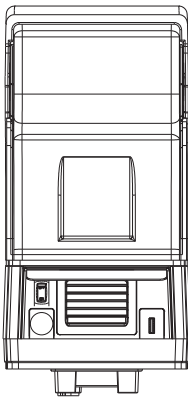

Custom Programmed Chip

## **Resetting the Pre-Set Buttons to the original factory settings**

1. Access the Owner Controls by activating the power switch located on the back of the motor base while depressing button 2.
2. Once the unit powers up, it will cycle through three screens then stop on the motor status screen. Depress button 2 again, within 12 seconds, to scroll through the menu settings.
3. Scroll using button 2. The screen will display "1 TO OVERWRITE CURRENT PROGRAM". Depress button 1 to reset to the original factory settings.

### **IMPORTANT NOTES!**

**Programming Chip:** If the above programming steps are taken and the custom programming does not appear with the first blend cycle, turn the chip 180° (side-to-side) and try again.

# PROGRAMMING

## Recipe Options Arranged by recipe number (#) and drink type:

#	DRINK TYPE	DESCRIPTION	RUN TIME
1	General Purpose/ Smoothie	Ramps up to 60% for 18 seconds	:18
2	Double Smoothie	Ramps up to MED (45%) for 6 seconds, then (58%) for 8 seconds, then HIGH (85%) for 4 seconds	:18
3	Frozen Coffee & Juices	Ramps up to LOW (25%) for 4 seconds then to MED (60%) for 14 seconds	:18
4	Ice Cream Drinks	Ramps up to MED (55%) for 5 seconds, then LOW (25%) for 7 seconds, then (12%) for 16 seconds	:28
5	Double & Hard to Blend Ice Cream Drinks	Ramps up to MED (51%) for 10 seconds, then ramps up to HIGH (85%) for 10 seconds	:20
6	Thick Hard-To-Blend	Ramps up to LOW (15%) for 7 seconds, then gradually ramps up to HIGH (82%) for 21 seconds	:28
7	Medium Smoothie	Gradually ramps up to HIGH (100%)	:20
8	Hard to Blend Smoothie	Gradually ramps up to HIGH (100%)	:25
9	Thick Smoothie	Ramps up to MED (50%) for 15 seconds, then ramps up to HIGH (100%) for 20 seconds	:35
10	Mix, Light Juice	Runs on LOW (10%)	:04
11	Heavy Smoothie	Runs at MED-HIGH (75%), ramps up, back down, then up to HIGH (100%)	:40
12	Hard to Blend Smoothie	Runs on LOW (7%) for 25 seconds, quickly ramps up to HIGH (100%), then decreases to LOW (7%), and quickly back to HIGH (100%)	:40
13	Regular Iced Coffee	Quickly ramps up to HIGH (100%)	:09
14	Double Iced Coffee	Quickly ramps up to HIGH (100%)	:13
15	Thick Coffee	Ramps up to MED (55%), gradually decreases to LOW (7%), then quickly up to HIGH (100%)	:30
16	Multiple Coffees	Ramps up to LOW (25%), gradually ramps up to MED (50%), then up to HIGH (100%)	:25

17	<b>Multiple Coffees 2</b>	Ramps up to LOW (25%), gradually ramps up to MED (50%), then up to HIGH (100%)	:30
18	<b>Small Coffee</b>	Gradually ramps up to MED-HIGH (75%)	:14
19	<b>1-2 Drink Cocktail</b>	Ramps up to HIGH (90%)	:13
20	<b>3-4 Drink Cocktail</b>	Ramps up to MED (45%), then ramps up to HIGH (100%)	:25
21	<b>Kids Cup</b>	Starts at MED (55%), then decreases to LOW (7%), then to HIGH (100%)	:30
22	<b>Bar Shake</b>	Gradually steps up to HIGH (100%)	:25
23	<b>Bar Special</b>	Ramps up to MED (58%), decreases to LOW (22%), then gradually steps up to HIGH (100%)	:35
24	<b>Utility Blend</b>	Ramps up to MED (40%), then gradually increases to MED-HIGH (75%)	:25
25	<b>1 Shake</b>	Ramps up to MED (50%), decreases to LOW (25%), then gradually decreases to LOW (15%)	:20
26	<b>2 Shake</b>	Ramps up to MED (50%), decreases to LOW (25%), then gradually decreases to LOW (17%)	:30
27	<b>3 Shake</b>	Ramps to HIGH (100%), decreases to LOW (25%), then decreases to LOW (15%)	:20
28	<b>Ice Cream Drink</b>	Ramps up to MED-LOW (35%), then ramps to MED-HIGH (75%)	:15
29	<b>Small Shake</b>	Ramps up to MED (58%), then decreases to LOW (25%)	:10
30	<b>Hard to Blend Shake</b>	Ramps up to MED-HIGH (80%), decreases to MED (51%), then gradually increases to HIGH (100%)	:25
31	<b>General Program 1</b>	Ramps up to HIGH (100%)	:25
32	<b>General Program 2</b>	Slowly ramps up to HIGH (100%)	:45
33	<b>General Program 3</b>	Quickly ramps up to MED (40%), decreases to LOW (15%), then up to HIGH (90%)	:24
34	<b>General Program 4</b>	Quickly ramps up to MED (45%), then gradually increases to MED-HIGH (75%)	:35

# MACHINE ASSEMBLY

## Compact Cover

### Cover Door:

1. The cover door can be removed by opening it until the door is horizontal. Then, gently spread the sides of the door over the round hinges and remove.
2. To reinstall the cover door, gently spread the sides of the door and place the door hinge cutouts over the round hinges.

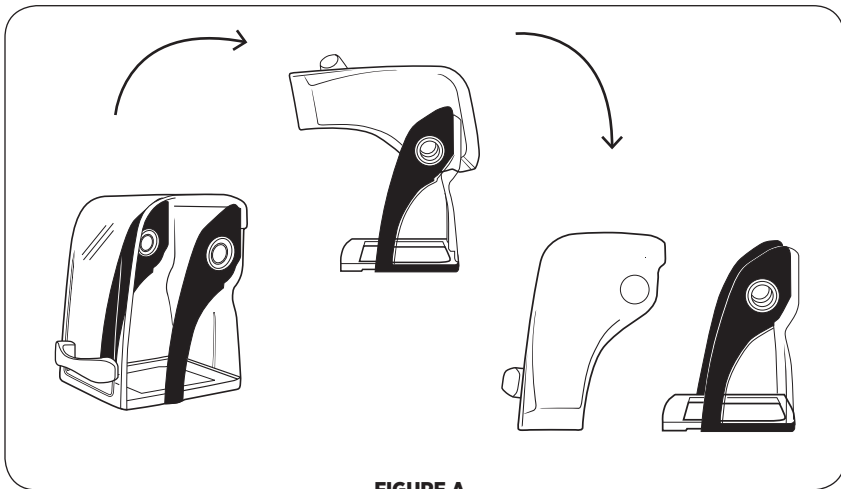

FIGURE A

## IMPORTANT NOTES!

### Containers:

- The Quiet One® machines are optimized for use with the Vitamix® 48 oz. / 1,4 L Advance® container (3 sided container). The 64 oz. / 2,0 L standard container will not fit in the compact cover used on the The Quiet One®. Contact Vitamix customer service at 800-886-5235 or contact your distributor for more information.
- Outside the United States and Canada, your machine may come with a different container configuration.

**Back Cover:**

For enhanced sound reduction, the sound enclosure for the The Quiet One® is secured to the base using a patented magnetic system. Aside from the advantages of reducing blending noise over that of mechanically attached door systems, the magnetically attached system allows for fast and easy removal for cleaning.

**To remove the sound enclosure:**

- First ensure that the container has been removed from the unit.
- Grasp the enclosure with both hands.
- Tilt slightly back and pull the enclosure straight up (See Figure B).

**To replace the sound enclosure:**

- Start with the back cover detached from the cover door
- Align the opening in the base plate of the back cover (See Figure C)
- Start on one side of the centering pad and slowly lay the back cover into position ensuring that the sound dampening pad is not pinched by any portion of the base plate (Figure D)

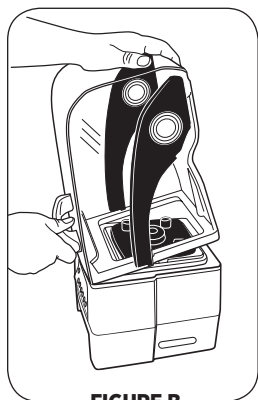
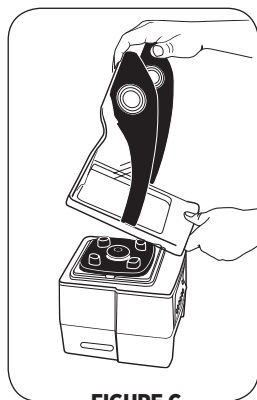
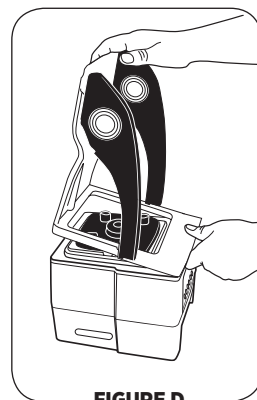
**FIGURE B****FIGURE C****FIGURE D**

# MACHINE ASSEMBLY

## **Two-Piece Lid** (Figure A)

**48 oz. / 1,4 L Advance® Container**

**The two-piece lid is easy to clean and easy to put on, take off and seal.**

- To remove a fully latched lid, lift the two tabs and pull upward and off.
- Twist the center lid plug to fasten or remove.

## **One-Piece Lid** (Figure B)

**48 oz. / 1,4 L Advance® Container**

**The one-piece lid is easy to clean and easy to put on, take off and seal.**

- There is no lid plug for this lid.
- Ingredients can be added through port on top.

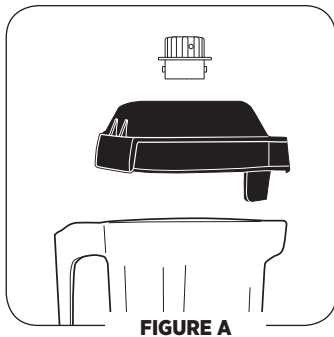

**FIGURE A**

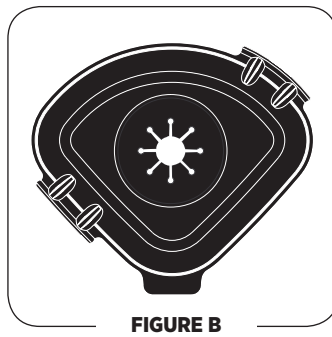

**FIGURE B**

To secure lid plug, rotate it so one tab locks between the notches on top of rubber lid

## Blade Assembly

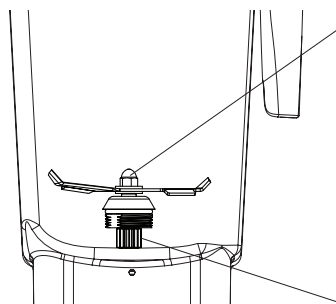

**Blade Agitator Assembly:** The blade assembly includes a precision-hardened stainless steel blade with enclosed double sealed steel ball bearings for maximum durability. The rugged blade assembly literally explodes molecules of food and ice in the container, helping every batch to homogenize more effectively. The blades do not need to be removed for normal cleaning. (Refer to the information below to remove or replace.)

**Drive Spline:** Inserts into drive socket on the motor base to turn the blade.

**Note:** Removing and replacing your container while the coupling is still rotating will strip the drive spline “teeth.” **(This part is NOT removable.)**

**Retainer Nut:** Must be snug. Order the available Retainer Nut Wrench for best results. (Refer to the information below to remove or replace.)

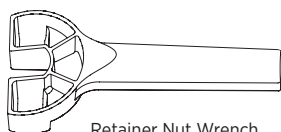

Retainer Nut Wrench

## Blade Assembly Removal

At times, it may be necessary to give your blades additional cleaning. An easy-to-use blade assembly removal wrench (Item #15596) may be purchased. Turn the container upside down and grip firmly. Insert retainer nut wrench in groove of retainer nut and rotate counterclockwise to loosen. Then grip blades with a cloth and remove retainer nut by hand.

**Replacing Blade Assembly:** With the container upside down, grip blades with cloth, insert into the container bottom and align with flat sides of container opening. Place retainer nut on and hand tighten. Using the retainer nut wrench, carefully turn clockwise until secure, using wrench.

**Do not force.** If it is not tight enough, you will notice increased container noise.

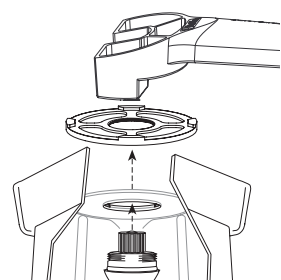

Retainer Nut Wrench in use



## WARNINGS!

Never use a blade assembly with loose, damaged or nicked components.

**Caution:** Do not remove blades or blade assembly unless absolutely necessary! Never attempt to take the blade assembly itself apart. This will void the warranty.



# INSTALLATION

## In-Counter Machine

### Preparing the counter Area:

- Before cutting holes, make sure that there is adequate clearance under the counter for the motor. The motor will extend about 3.0 in. / 7,6 cm below the counter but it is best to allow at least 10.0 in. / 25,4 cm from the under-counter to shelves or any other equipment under the counter. Also, when using the removable cover design, the back of the hole must be at least 4.3 in. / 10,8 cm from any wall to allow for cover door clearance.
- An extra 4.0 in. / 10,2 cm of open space above the top of the cover will be needed for placement and removal of the In-Counter machine.
- If installing unit into a cabinet with doors, including cabinets with a curtain or extended skirt, a 4.0 in. / 10,2 cm diameter flexible duct (dryer hose) must be used to vent exhaust. Attach the duct to the bottom exhaust by forcing the end of the hose over the exhaust baffle of the unit. Run the duct out of the cabinet for proper ventilation. Multiple units should not vent to a common manifold unit but to separate places with separate vent ducts.
- When cutting holes for placement of multiple In-Counter units, position the edge of the machines at least 12.0 in. / 30,5 cm apart to ensure quick cleaning and proper venting between machines.
- It is recommended that for a 120 V unit In-Counter installation, you have at least one 20 amp outlet per machine under the counter, available within 6 ft. / 1,8 m of the machine. 220 V and 100 V units require a dedicated line. Consult an electrician for proper electrical needs.
- The In-Counter unit also requires a gasket (provided in the machine's original package) to be placed between the machine and the counter.
- Refer to The Quiet One® In-Counter template (provided in the machine's original package) for detailed installation guidelines and a template.



## WARNINGS!

**Do not** vent hose into a wall, ceiling or a concealed space of a building or cabinet.  
**Do not** use hose clamps or equivalent to attach exhaust hose on machine.  
When removing blender from the counter, always remove the container, cover door and back cover from the machine first. Do not strike the blender when removing from the counter. Do not use the In-Counter gasket on a wooden counter. Discoloration of the counter will occur.

## IMPORTANT NOTES!

Do not use the In-Counter on wooden counter tops. The gasket located between the machine and the counter will leave permanent black marks on wood. The area below the counter must have adequate ventilation to provide air circulation around each motor. This will prolong the life of your machine. If storing powders, mixes, sugars, etc., around the machine, make sure containers are tightly sealed. The intake and exhaust air caused by running the machine will disperse any loose products.

## On-Counter and In-Counter Blending Station

### Electrical Requirements:

- 120 V, 50/60 Hz, 15 amps
- Uses a U.S.A. three-prong grounded cord.
- 20 amp outlet per machine is recommended.

### Do not use extension cords with machine.

- 220 – 240 V, 50/60 Hz, 1300 – 1550 Watts
- 100 V (Japan), 50/60 Hz, 1000 Watts

### On-Counter Dimensions:

- 18.0 in. / 45,7 cm high with lid closed
- 24.5 in. / 62,2 cm high with lid open
- Depth: 10.7 in. / 27,2 cm with handle
- Width: 8.5 in. / 21,6 cm

### In-Counter Dimensions:

- 16.5 in. / 41,9 cm high with lid closed
- 23.0 in. / 58,4 cm high with lid open
- Depth: 10.7 in. / 27,2 cm with handle
- Width: 8.5 in. / 21,6 cm
- Depth below counter: 1.2 in. / 3,0 cm

### Recommended distance between machines and under hang or wall:

12.0 in. / 30,5 cm from the edge of each machine or as far apart as possible

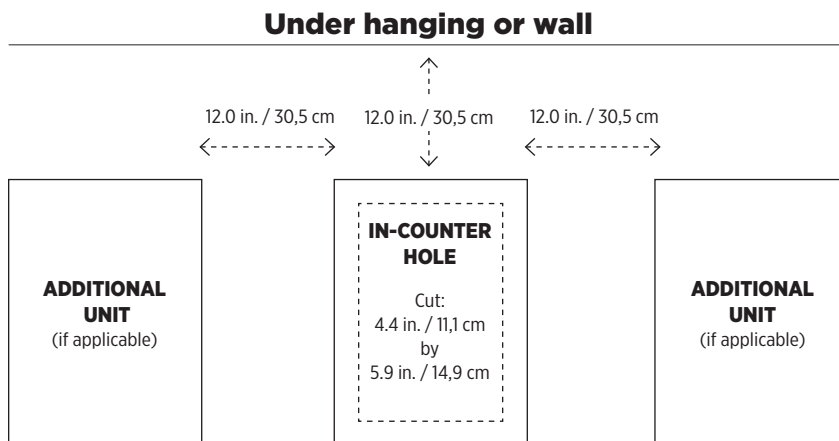

# CARING FOR YOUR MACHINE

## Cleaning Products

Solid Supra, Solid Power, \_\_\_\_\_  
Guardian Acclaim, Solid Guardian Plus,  
Solid Super Impact, Solid Insure

## Suppliers in U.S.A.

**Ecolab, Inc.**, St. Paul, MN  
800-352-5326  
www.ecolab.com

Diverpak \_\_\_\_\_  
Eclipse H2, Liqui-Safe L7  
Acclean  
Poly-Brite

**Diversey**, Livonia, MI  
800-521-8140

Glow MB-1 \_\_\_\_\_  
Lustre NC-25  
Lustre Plus

**Wesmar Company, Inc.**  
Seattle, WA 206-783-5344  
www.wesmar.com

PSRA 41-D, PSRA 41-E \_\_\_\_\_  
Liqui-Ware 1, Liqui-Ware MC  
D-Flex, Sur-Met

**Anderson Chemical Co.**  
Litchfield, MN  
800-366-2477  
www.andersonchemical.com

## Rinse Aids

Solid Rinse Dry, Solid Brilliance, \_\_\_\_\_  
Jet Dry, Rinse Dry

**Ecolab, Inc.**, St. Paul, MN  
800-352-5326  
www.ecolab.com

## Destainer

NuWare \_\_\_\_\_

**Diversey**, Livonia, MI  
800-521-8140

## IMPORTANT NOTES!

**Cleaning Products:** Do not use abrasive cleaning agents or concentrated bleach when cleaning. Do not use any cleaners containing quaternary sanitizers on polycarbonate components (i.e., Advance® containers, covers). Do not use any of the following cleaning products: automatic dishwashing detergents, oven cleaners, steel wool or other abrasive pads.

**Cover:** Do not wash cover door, handle or back cover in dishwasher. It is recommended that the handle not be disassembled during cleaning. However, if you choose to disassemble the handle from the cover, make sure to not over-tighten it when reattaching it to the cover. Doing so will cause damage.

**Container:** Do not let mixtures, liquids or food products dry in the container. Rinse after use. Dry product may lock around the blade and weaken/tear the bearings seal when restarted. Do not place containers in the freezer. Extremely low temperature combined with hot ingredients and/or the immediate rapid action of the blade may crack the container. Microwaving and automatic dishwashing are not recommended.

**Motor Base/Control Panel:** **Unplug the power cord** and gently wash the outside surface with a damp soft cotton cloth moistened with a mild solution of warm water\* and nonabrasive detergent or nonabrasive liquid spray cleaner. Be careful to not scratch or scrub the display window on the control panel. **Never immerse motor base in water or other liquid.** Dry with a soft cotton cloth.

**Lid:** Wash in warm, soapy water. Rinse clean under running water and dry.

**Cover Door:** The cover can be removed (see pages 14 and 15) and cleaned by placing under running water and washing with a soft cloth. Wipe dry and replace back on the base.

**Sound Dampening Gasket and Container Centering Pad:** The sound dampening gasket located between the base and the cover door can be removed for cleaning by simply peeling it off the base after the cover has been removed. (See pages 14 and 15 for cover removal).

Wash the gasket and pad in warm, soapy water. Rinse clean under running water and dry. Reassemble before use. To reinstall the sound dampening gasket, simply lay it on the base making sure that it fits snugly against the centering pad. Replace the sound enclosure as directed on page 15. Make sure the gasket is seated properly against the blender and the centering pad. The gasket and the centering pad should be flat on the motor base.

**Container:** The Advance® container has been designed to be chemical resistant. However, for maximum container life, hand washing is recommended.

**To Clean:** Wash all container parts in warm soapy water. Rinse and drain. Do not soak the blade agitator assembly.\*\*

**To Sanitize:** After all solid residue is removed, fill container  $\frac{3}{4}$  full with a sanitizing solution mix.\*\*\* Return container to motor base and firmly position the two-piece lid. Run machine on a high speed for 30 seconds. Turn machine off and allow mixture to stand in the container for an additional 1  $\frac{1}{2}$  minutes. Pour out bleach mixture. Return container to motor base and run machine empty for an additional 5 seconds. Do not rinse after sanitizing. Allow container to air dry.

## IMPORTANT NOTES!

**Sound Dampening Gasket:** Do not wash in the dishwasher. High temperatures and chemicals may cause the pad to swell. Do not soak. The gasket may absorb water and swell. It can take 24-48 hours of air drying before it returns to its original size.

**Blade Assembly:** Do not soak the blade agitator assembly.

\* Be sure to wring excess water out of cloth or sponge when cleaning around the controls or any electrical part.

\*\* To prolong polycarbonate container life, Vitamix recommends using soaps with a low PH balance, such as a liquid dishwashing detergent (Ivory Liquid®). Due to the nature of polycarbonates, automatic dishwashing is not recommended.

\*\*\* Recommended sanitizing solution: 1.5 tsp. / 7,4 ml institutional or household bleach in 2 qt. / 1,9 L water.

# TROUBLESHOOTING

<b>Problems:</b>	<b>Possible Actions:</b>
<ul style="list-style-type: none"> <li>• Loud noise from blender container blade area</li> <li>• Container blades do not spin</li> <li>• Increased vibration</li> <li>• Leaking from bottom of container</li> </ul>	<ul style="list-style-type: none"> <li>a. Broken or worn drive socket. Replace (Item #891). Instructions are included with part.</li> <li>b. Check blade assembly for loose, damaged or nicked components and replace.</li> <li>c. Tighten retainer nut with the retainer nut wrench moving clockwise until it is snug. (See page 17.)</li> </ul>
<ul style="list-style-type: none"> <li>• Loud grinding noise from the blender motor</li> </ul>	<p>Damaged motor bearings, your machine may need to be repaired.</p>
<ul style="list-style-type: none"> <li>• Machine will not run</li> <li>• Display window does not say "Ready"</li> </ul>	<ul style="list-style-type: none"> <li>a. Double-check to make sure power cord is firmly in power outlet.</li> <li>b. Check to make sure the On/Off power switch is in the on position.</li> <li>c. Turn the On/Off power switch to off, then on, to reboot the electronics.</li> </ul>
<ul style="list-style-type: none"> <li>• Machine starts then shuts off</li> </ul>	<p>Make sure there is power to the machine.</p>
<ul style="list-style-type: none"> <li>• Display window reads "SHUT DOWN SEE MANUAL"</li> </ul>	<p>Let the machine cool for an hour, restart.</p>
<ul style="list-style-type: none"> <li>• Display window reads "MOTOR LOCKED PROGRAM TERMINATED"</li> </ul>	<p>Let the machine cool for an hour, restart.</p>
<ul style="list-style-type: none"> <li>• Machine is running irregularly</li> <li>• "NO PROGRAM" is displayed when a button is pushed</li> <li>• Button pressed starts wrong program</li> <li>• Machine starts by itself</li> <li>• A specific program button is defective</li> <li>• Machine does not work when first tried</li> <li>• Machine works but no information displayed on screen</li> <li>• Program buttons run the blender on the same speed</li> </ul>	<ul style="list-style-type: none"> <li>a. Turn the machine off and on again to reset the programming.</li> <li>b. Try plugging the machine into a new outlet.</li> </ul>

<b>Problems:</b>	<b>Possible Actions:</b>
<ul style="list-style-type: none"> <li>• Display window reads "CORRUPT DATA"</li> </ul>	<p>Turn the machine off and on again to reset the programming.</p>
<ul style="list-style-type: none"> <li>• Display window reads "THERMAL SENSOR FAILURE"</li> </ul>	<p>Call Vitamix technical support.</p>
<ul style="list-style-type: none"> <li>• Machine stops in the middle of its blend cycle and resets; display window reads "VITAMIX GENERAL PROGRAM" then "READY"</li> </ul>	<ul style="list-style-type: none"> <li><b>a.</b> Plug the machine into its own power supply.</li> <li><b>b.</b> Make sure the machine is not running on a long extension cord.</li> </ul>
<ul style="list-style-type: none"> <li>• If the machine has overheated: The motor will stop and the message "MOTOR HAS OVERHEATED REMOVE THE CONTAINER, THEN PRESS START," will scroll across the display window, while the words "HOT SHUTDOWN" will remain in the display window alerting you of the problem.</li> </ul>	<p>Remove the container, shut the cover door and press the Start/Stop button and run the machine for two minutes. When the motor is cool, "READY" will appear in the display window.</p>

**If you cannot fix your machine with these suggestions,** technical help is available by calling Vitamix® technical support at 800-886-5235. If you purchased your equipment outside the U.S.A., contact your local Vitamix Distributor or telephone the Vitamix International Division at +1.440.782.2450 or email [international@vitamix.com](mailto:international@vitamix.com) for a distributor in your country. For online help, visit [www.vitamix.com/foodservice](http://www.vitamix.com/foodservice).

# WARRANTY

## LIMITED WARRANTY

In order to maximize the life and keep your Vitamix® product in good working order, it is important that you follow a few simple maintenance tips:

1. Periodically inspect the drive socket for visible wear and tear, cracks, or brakes to the socket. If damage is found, replace the drive socket with the extra drive socket enclosed with your blender. To purchase additional replacement drive sockets contact Vitamix at 1-800-437-4654 (1-800-4DRINK4) for a dealer near you. For customers outside the U.S.A., contact your authorized Vitamix Distributor, or call the Vitamix International Division at +1.440.782.2450 or email [international@vitamix.com](mailto:international@vitamix.com) for a distributor near you.
2. Manually rotate the blade bearing assembly to make sure it turns without hesitation or doesn't spin too freely. If the blade hesitates or spins too freely, contact Vitamix at 1-800-437-4654 (1-800-4DRINK4) for warranty information or a dealer near you. For customers outside the U.S.A., contact your authorized Vitamix Distributor, or call the Vitamix International Division at +1.440.782.2450 or email [international@vitamix.com](mailto:international@vitamix.com) for a distributor near you.
3. Never run the machine without the centering pad properly placed on the base. Vita-Mix® Corporation (hereinafter "Vita-Mix") warrants to the original end-user (proof of purchase required) purchased in the U.S.A., that this commercial Vita-Mix blender (hereinafter the "Equipment") is free from defects in material and workmanship for the warranty periods applicable to the Equipment as described herein and subject to the conditions set forth below.

### Motor Base

Vita-Mix warrants to the original end-user that:

- If the motor base fails within thirty (30) days from the date of purchase, Vita-Mix will replace the motor base without charge.
- If the motor base fails after thirty (30) days but within one year from the date of purchase, due to a defect in materials or workmanship, Vita-Mix will assume the cost of all parts and labor necessary to repair the motor base.
- If the motor base fails after one year but within three (3) years from the date of purchase due to a defect in materials or workmanship, Vita-Mix will assume the cost of the parts deemed necessary to repair the base.

### Container, Lid, Blade Assembly, Drive Socket and Sound Enclosure (if included)

The container, lid, blade assembly, drive socket and where included a Vita-Mix manufactured sound enclosure, are warranted against defects in material and workmanship for one year from the date of purchase.

### Conditions

- The warranties contained herein run only to the original end-user and are not transferable. To make a warranty claim, proof of purchase is required.
- This warranty is the sole remedy of the purchaser and sets forth the only obligations

of Vita-Mix and does not cover normal wear-and-tear, abuse, misuse, negligent use, alteration of the base or container (or the sound enclosure), or exposure to extreme conditions and is only valid if the Equipment is used in accordance with the accompanying instruction booklet (which may also be accessed at [www.vitamix.com/foodservice](http://www.vitamix.com/foodservice)).

- If applicable, improper installation or ventilation in the case of the in-counter model of the Equipment, or placing the Equipment in a sound enclosure not manufactured by Vita-Mix will void this warranty.
- This warranty is void in the event that repairs to the Equipment are performed by someone other than Vita-Mix or an authorized Vita-Mix Service Center. Vita-Mix will not be responsible for the cost of any unauthorized repairs.
- The sole obligation of Vita-Mix under this warranty is to repair or replace the warranted part or parts as determined exclusively by Vita-Mix.

**In no event, whether based on contract, indemnity, warranty, tort (including negligence), strict liability or otherwise, shall Vita-Mix be liable for any special, indirect, incidental or consequential damages whatsoever including, without limitation, loss of profit or revenue. The above limited warranty is your exclusive remedy, and you and Vita-Mix hereby expressly disclaim all other warranties or conditions, express or implied, statutory or otherwise, including any implied warranty of merchantability and any implied warranty of fitness for a particular purpose, and, without limiting the generality of the foregoing, you and Vita-Mix hereby expressly exclude, to the extent permitted by law, the application of any sale of goods legislation and the United Nations Convention on Contracts for the International Sale of Goods, as may be applicable.**

Some jurisdictions do not allow a limitation on implied warranties or on special, incidental or consequential damages.

No employee of Vita-Mix or any other person is authorized to make any warranty in addition to or amendment of the warranties made herein. For warranty details for machines purchased outside the U.S.A., contact your authorized Vita-Mix distributor, or call the Vita-Mix International Division at +1.440.782.2450 or email [international@vitamix.com](mailto:international@vitamix.com) for a distributor near you.

In the event your Vita-Mix blender needs service or repair covered by the terms of this warranty, please call the Vita-Mix Corporation for warranty assistance. For machines purchased in the U.S.A., call Vita-Mix Technical Support: 800-886-5235. If purchased outside the continental U.S.A., contact your authorized Vita-Mix Distributor, or telephone the Vita-Mix International Division at +1.440.782.2450 or email [international@vitamix.com](mailto:international@vitamix.com) for a distributor near you.

Any item sent to Vita-Mix pursuant to the terms hereof must be sent in original or sufficient packaging. Customer is responsible for in-bound freight costs for warranty service. Do not return or send in products without the approval from Vita-Mix. All product returns must have the Return Authorization Number clearly marked on the outside of the box. Any product that is sent to Vita-Mix without prior authorization or approval will be returned to the shipper's address "as is" without repair.



# PARTS LIST

## The Quiet One®

- #15092** Splash lid for 48 oz. / 1,4 L Advance® container
- #15986** Lid only (no plug) for 48 oz. / 1,4 L Advance® container
- #15985** Two-part lid assembly for 48 oz. / 1,4 L Advance® container
- #15978** 48 oz. / 1,4 L Advance® container, blade assembly & lid assembly
- #15980** 48 oz. / 1,4 L Advance® container only
- #15979** 48 oz. / 1,4 L Advance® container, blade assembly, no lid assembly
- #15990** Advance® blade agitator assembly
- #15585** Retainer nut
- #891** Drive socket
- #15579** Sound-reducing centering pad
- #15080** Compact back cover and cover door with removable hinge design
- #15081** Compact cover door
- #15082** Compact back cover
- #15107** Isolation Gasket
- #15083** In-Counter gasket

## IMPORTANT NOTES!

- Outside the U.S.A. and Canada, your machine may come with a different container configuration. Contact your local Vitamix Distributor for item numbers.
- Other than the drive socket, blade assembly and retainer nut, this unit is not user serviceable.

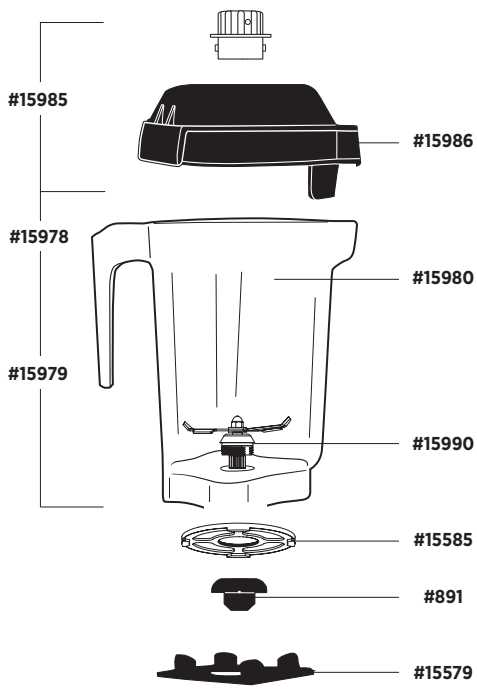

**Items Sold Separately:**

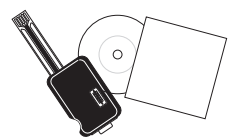

**#15606**  
Software Kit - USB Version



**#15644**  
Extra Programming Chip  
for Software Kit



**#15988**  
One-Piece Lid

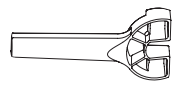

**#15596**  
Retainer Nut Wrench

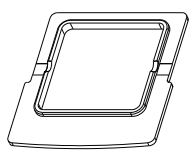

**#15107**

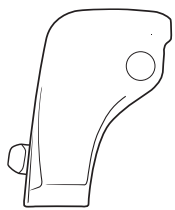

**#15081**



**#15082**



**#15080**

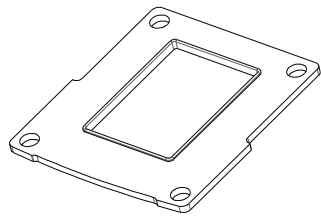

**#15083**

# SPECIFICATIONS

## The Quiet One®

### Electrical Requirements:

- 120 V, 50/60 Hz, 15 amps
- Uses a U.S.A. three-prong grounded cord.
- 20 amp outlet per machine is recommended.

### Do not use extension cords with machine.

- 220 – 240 V, 50/60 Hz, 1300 – 1550 Watts
- 100 V (Japan), 50/60 Hz, 1000 Watts

### On-Counter Dimensions:

- 18.0 in. / 45,7 cm high with lid closed
- 24.5 in. / 62,2 cm high with lid open
- Depth: 10.7 in. / 27,2 cm with handle
- Width: 8.5 in. / 21,6 cm

### In-Counter Dimensions:

- 16.5 in. / 41,9 cm high with lid closed
- 23.0 in. / 58,4 cm high with lid open
- Depth: 10.7 in. / 27,2 cm with handle
- Width: 8.5 in. / 21,6 cm
- Depth below counter: 1.2 in. / 3,0 cm

When applicable:



To see the complete line of Vitamix® products, visit [vitamix.com/foodservice](http://vitamix.com/foodservice)



### Vita-Mix® Corporation Commercial Division

8615 Usher Road, Cleveland, Ohio 44138 U.S.A.

Tel: 440.235.0214 Email: [commercial@vitamix.com](mailto:commercial@vitamix.com)

©2010 Vita-Mix Corporation. No part of this publication may be reproduced or transmitted in any form or by any means or stored in a database or retrieval system without the written permission of the Vita-Mix Corporation.

Printed in the U.S.A. 102865 12/10