



Giotto

OVEN

Use and maintenance manual

GT110
GT140



HEat.
smART.
Partner in Baking. Since 1963





We congratulate you for choosing a product designed and manufactured with cutting-edge technology.

The oven is checked and tested in the Manufacturer's plant before being delivered to the customer.

The "production process check sheet" enclosed with it guarantees that **each** step in the production process, from assembly to packaging, was carefully checked from both the operating and safety standpoints.

Before the installation, read the content of this manual **carefully**: it contains important information regarding product assembly and safety regulations.

The foundation

Our company was founded in 1963 by the Lorenzo, Luigi and Paolo Cuppone brothers. It immediately specialized in the production of ovens and equipment to prepare and cook pizza. The constant research and experimentation of new equipment that are even now the strength of our company, have led us to design and patent the machinery and ovens that have revolutionized the way pizza is made.

Technical service

Your Dealer can solve any technical problem regarding use and maintenance.

Do not hesitate to contact him in case of doubt.

CUPPONE since 1963

CUPPONE S.R.L.

Via Sile, 36

31057 Silea (TV) - ITALY

T +39 0422 361143

F +39 0422 360993

info@cuppone.com - www.cuppone.com

INTRODUCTION	3
Technical service.....	3
1 SAFETY INSTRUCTIONS	4
Symbols used in the manual	5
2 BASIC NOTIONS	6
Knowing your oven	6
Preparing to use the oven	6
Basic notions	6
Emergency controls	7
Some piece of advice.....	8
The turntable	9
Cooking tables.....	9
3 USE	10
4 MAINTENANCE AND CLEANING	36
Warnings.....	38
Oven cleaning.....	38
Replacing components.....	40
Oven downtime for prolonged periods	41
Disposal at end of life	41
Disposing of ashes and food residues	41
6 WARRANTY	42
7 SOMETHING IS NOT WORKING	43

1 SAFETY INSTRUCTIONS

Symbols used in the manual and on the labels applied to the machine



Indicates that caution is required when performing an operation described in a paragraph that bears this symbol. The symbol also indicates that maximum operator awareness is required in order to avoid unwanted or dangerous consequences



Indicates that the surfaces marked with this symbol may be hot and must therefore be touched carefully



Dangerous voltage



Risk of explosion



Reference to another chapter where the subject is dealt with in more detail.



Manufacturer's tip



Manufacturer's warning



Indicates that it is necessary to read carefully the paragraph marked with this symbol before installing, using and maintaining the equipment



Read this guide carefully before using and maintaining the appliance, and keep it with care in an accessible place for any future consultation by the various operators.

- Moreover, the manual must always accompany the product through its life, even in case of transfer.
- Before performing any maintenance, replacing components or carrying out any routine/extraordinary cleaning, disconnect the electricity supply.
- Unauthorised actions, tampering or modifications that do not follow the information provided in this manual can cause damages, injuries or fatal accidents and null and void the warranty.
- Use or maintenance that fail to comply with the instructions in this manual may cause damage, injury or fatal accidents.
- The serial plate provides important technical information. This is vital in case of a request for maintenance or repair of the equipment: please do not remove, damage or modify it.
- Some parts of the equipment can reach high temperatures. We advise you to avoid touching surfaces and not to get materials either flammable or sensitive to heat near the appliance.
- Do not rest objects on the oven, above all if built in material sensitive to heat.
- These appliances are intended to be used for commercial applications, for example in restaurant kitchens, canteens, hospitals and commercial companies such as bakeries, butcher shops, etc., but not for the continuous and mass production of food. A use other

than the stated one is considered improper, potentially dangerous for people and animals and might permanently damage the appliance. The improper use of the equipment shall void the warranty.

- This appliance can be used by children aged from 8 years and above and persons with reduced physical, sensory or mental capabilities or lack of experience and knowledge if they have been given supervision or instruction concerning the use of the appliance in a safe way and understand the hazard involved. Children must not play with the appliance. Cleaning and user maintenance shall not be made by children without supervision.
- To clean the appliance, any of its components or accessories and the sub-structure DO NOT use:
 - aggressive, abrasive, powder or corrosive detergents (e.g. hydrochloric or sulphuric acid, caustic soda, etc.).
 - abrasive or sharp tools (e.g. abrasive sponges, scrapers, steel brushes, etc.);
 - steamed or pressurised water jets.
- The staff using the appliance must be professionally prepared and periodically trained on its use, as well as the safety and accident prevention regulations.
- Children must be supervised to make sure they do not play with the appliance or parts of it.
- Always use tools resistant to heat (e.g. In steel). Cooking utensils in plastic or similar material might not withstand the oven high temperatures.
- Check regularly that fumes can be discharged safely. Do not obstruct the duct for any reason.
- FIRE RISK: leave the area around the appliance free and clean from fuels. Do not store flammable materials near this appliance.

The company cannot be held liable for any print or transcription errors, reserving the right to make changes where deemed suitable without prior notice.

Partial reproduction without the Manufacturer's consent is prohibited. Measurements are purely indicative and not binding.

The original language used to prepare this manual is English: the Manufacturer is not responsible for any translation/interpretation or print errors.

Safety instructions

- **WARNING: RISK OF EXPLOSION!** It is forbidden to use the oven in environments at risk of explosion.
- **WARNING:** always switch off the main switch when you finish using the appliance, above all during cleaning or in cases of prolonged downtime.
- If you notice any anomaly (e.g. damaged power cable, etc.), malfunction or fault, do not use the appliance and contact a Service Centre authorized by the Manufacturer. Demand original spare parts, or the Warranty will be null and void.
- Place the emergency phone numbers in a visible location.
- **WARNING:** it is forbidden to place flammable solids or liquids (spirits for instance) in the cooking chamber during the operation.
- Monitor the appliance during its entire operation, do not leave dishes in the oven unattended!
- Failure to follow these regulations may cause damage or even fatal injury, subsequently invalidating the guarantee and relieving the Manufacturer of all liability.
- We recommend you have the appliance checked by an Authorized Service Centre at least once a year.



The lower compartment can be used for storage (e.g. for pizza boxes).
We recommend you keep at least 7 cm [2.76 inches] free above the objects to allow free air circulation.

 Warning: do not obstruct the cooling fans located under the electrical panel.

Fig.1

2 BASIC NOTIONS

Knowing your oven

► Fig.2

Your oven can be used only to bake pizzas or similar dishes, such as bread or focaccia and to grill vegetables.

Its main parts are:

- ① Cooking chamber in stainless steel
- ② Chimney to vent any cooking fumes
- ③ Cooking surface in refractory bricks
- ④ Power cable socket
- ⑤ Face in stainless steel
- ⑥ Digital control display
- ⑦ Ventilation slots in the light compartment
- ⑧ Flue vent valve opening/closing knob
- ⑨ Plate rotation speed control joystick

The temperature in the chamber is controlled by boards that switch the heating elements on and off to keep the set temperature constant.

The oven can manage separately the powers:

- of the bottom part of the oven chamber;
- of the top part of the oven chamber.

Preparing to use the oven

Clean the oven and any accessories accurately, both externally and internally, following the instructions in the dedicated chapter rigorously.

Maintenance and cleaning - page 38.

Turning the oven on: **the first time** you use the oven, we recommend you set the temperature at **150 °C- 302 °F, 80%** percentage at the top, **20%** in the bottom for at least **8 hours, without placing any food inside**. During this time, keep the chimney flue fully open and the hood, if present, ON. In this first phase, because of the humidity evaporating from the insulating materials, the oven will give out unpleasant smells and fumes that will gradually disappear during the following operating cycles.

To switch the oven on and set its parameters, refer to:

Use - page 10

Fig.2

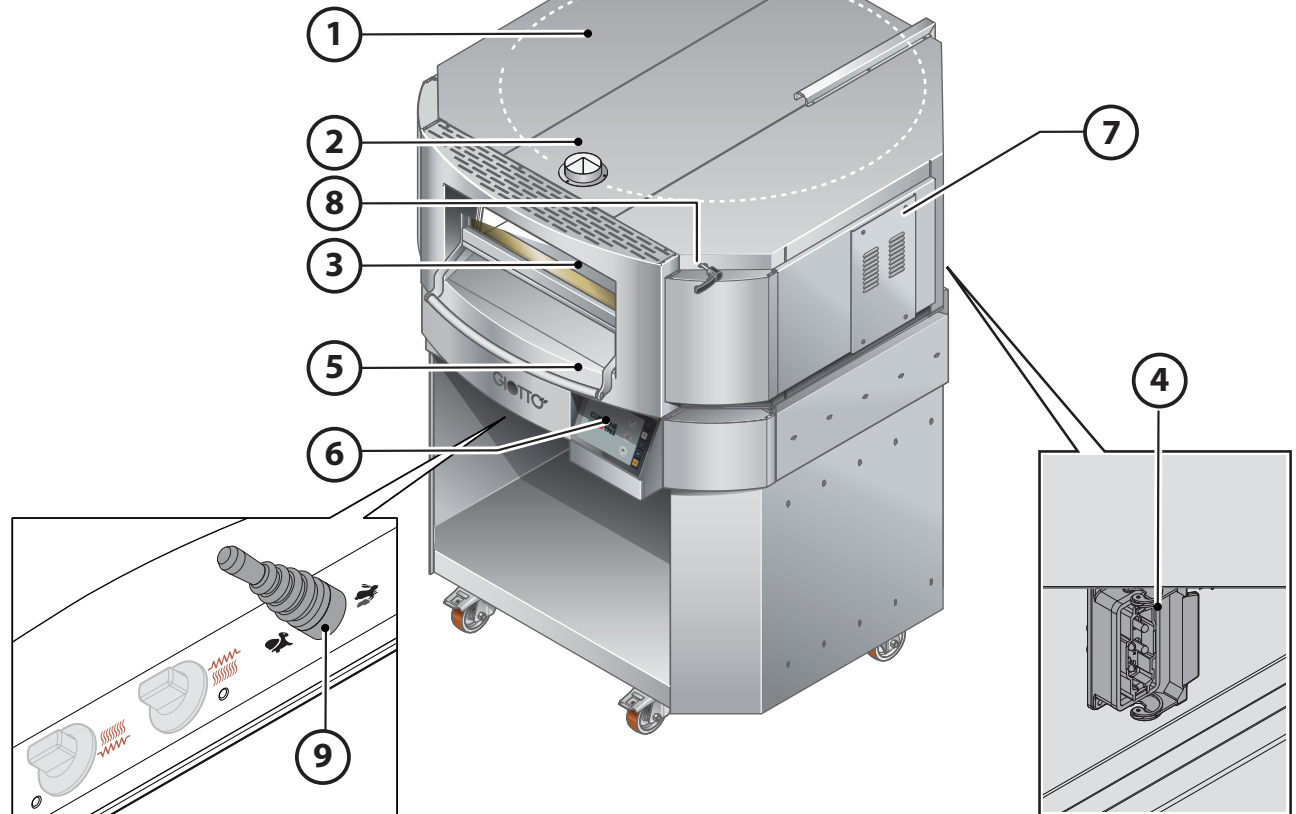

 **The first day of use is considered as a running-in period: during this time the refractory bricks and insulating material keep releasing humidity until they dry out completely.**

 **Some parts of the equipment can reach high temperatures. We advise you to avoid touching surfaces and not to get materials either flammable or sensitive to heat near the appliance.**

Do not rest objects on the oven, above all if built in material sensitive to heat.

Take care and use personal protection equipment (i.e. gloves) when putting food into the cooking chamber or getting it out.

Emergency controls (EMERGENCY SYSTEM)

⑪ **Emergency mushroom:** if pressed, it disables the turntable rotation, the display shows an alarm screenshot ▶ **Fig.4** and the buzzer can be heard. The mushroom must be used in a real emergency; to stop the turntable normally, acts on the "STOP" button on display (refer to page **13**). To unlock it and restart the normal working activity, rotate it clockwise.



Fig.4

EMERGENCY SYSTEM device

If the key is in ⑩ D.C. position ▶ normal use of the oven through the digital display.

If the key is on ⑩ OFF ▶

- The turntable rotation function is disabled, an alarm screen appears ▶ **Fig.4** and the buzzer is activated.
- The heaters are disabled and therefore do not heat up.
- The digital display remains on but only the following can be activated:
 - hood functions (light and speed)
 - room light.

If the key is in ⑩ M.C. position ▶

the oven can be controlled by the two thermostats, top and bottom using the knobs ⑧ and ⑨ rather than by the display.

This possibility is useful when there is a breakdown of an electronic component (e.g. Touch board or heater control board) which does not allow heating or adjusting the heaters.

This work mode must be used only in the event of an actual emergency in order to end the service pending the intervention of specialized personnel, the only one able to solve the problem.

If the key ⑩ is in M.C. position.

- The turntable rotation function is disabled.
- The top/bottom heaters are activated rotating the knobs ⑧ and ⑨ to the desired temperature:
 - ⑨ bottom temperature setting
 - ⑧ chamber temperature setting

After setting the temperature, the lights ⑫ and ⑬ come on to show that the heaters are working to reach the set temperature.

In this mode:

- if the Touch board fails, the digital display goes off and then:
 - the hood functions (light and speed) and the chamber light are deactivated.
- if the heater control board fails and the Touch board works:
 - the digital display remains on and only the hood (light and speed) functions and the chamber light can be activated.

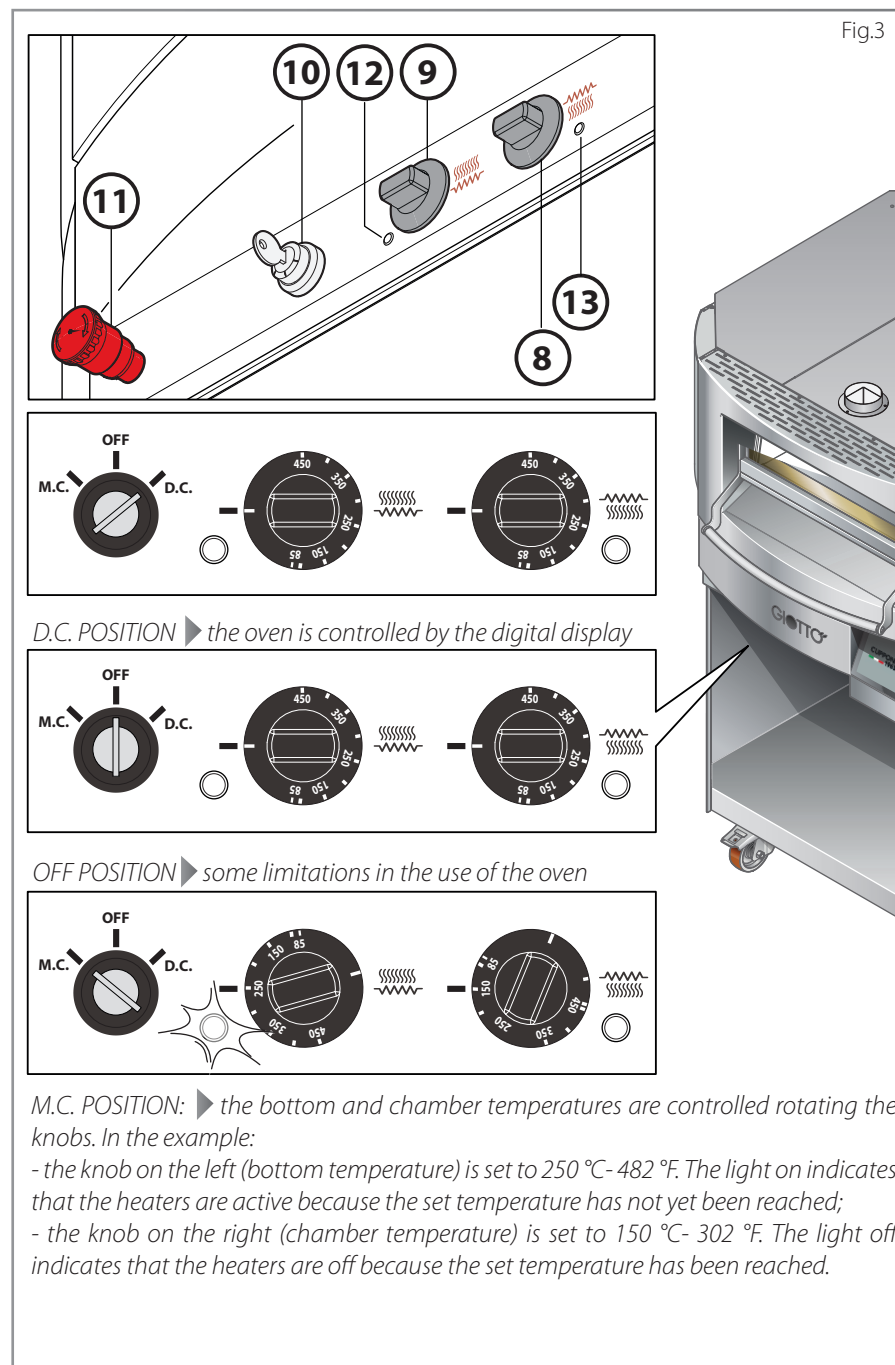

Fig.3

D.C. POSITION ▶ the oven is controlled by the digital display

OFF POSITION ▶ some limitations in the use of the oven

M.C. POSITION: ▶ the bottom and chamber temperatures are controlled rotating the knobs. In the example:

- the knob on the left (bottom temperature) is set to 250 °C- 482 °F. The light on indicates that the heaters are active because the set temperature has not yet been reached;
- the knob on the right (chamber temperature) is set to 150 °C- 302 °F. The light off indicates that the heaters are off because the set temperature has been reached.

Some piece of advice...

- Before starting cooking, always preheat the oven: this is vital to get good food. Preheating the oven **must last at least an hour**, it is therefore always preferable to use the programmed switch-on function so that the oven is already hot when the place opens and ready to cook the desired food.

 Programmed switch-on: page **28**

- During work, keep the refractory surfaces clean using a stiff bristle brush.
- Passing from a type of pizza to another, wait the time required for the oven to stabilize.
- Take your time when adjusting the cooking parameters according to the increase and/or decrease in the workload.
- An excess of flour in the cooking chamber can create smoke, smell and give the pizza an unpleasant taste.
- Clean the oven at the end of service.

WHAT IS PIZZAFORM?

Pizzaform is a Manufacturer's patent. It is a special press, produced in five models, to make pizza dough discs up to 52 cm in diameter [Ø 2.05 in.].

Its main features are:

- high hourly output, up to 400 pizzas an hour, without using specialized labour;
- consistent shape and thickness of the disc of dough, without giving up the traditional edge, obtained thanks to the special shape of the chrome plates;
- possibility of changing the thickness of the dough discs easily.



► Fig.5

In the ovens, products cook thanks to the combined action of:

- **radiation:** the heat and infrared rays produced by the top elements make products crunchy and golden
 - this parameter is controlled by the TOP percentage.
- **convection:** the hot air that circulates in the chamber cooks the product evenly
 - this parameter is controlled by the temperature setting in the chamber
- **conduction:** the bottom elements heat the refractory surfaces on which the products lie
 - this parameter is controlled by the temperature and the BOTTOM percentage.

UNSATISFACTORY COOKING RESULTS

If the cooking results are not as expected, try and check the following:

- **incorrect oven parameters:**
 - temperature in the chamber either too high or too low
 - power (percentage) of the BOTTOM or TOP either too high or too low
- **incorrect preheating:**
 - preheating is vital to get superb results right from the first pizza
 - during preheating, the BOTTOM percentage has been set too high: the refractory surfaces (without pizzas) have become too hot and burnt the first pizzas.
- **incorrect use of the venting chimney:**
 - in the upper part of the cooking chamber there is a venting chimney that must be opened or closed depending on the type of product to be cooked: for example, if it is not opened, there may be too much humidity in the chamber that prevents the infrared rays of the top elements from browning the surface of the products.

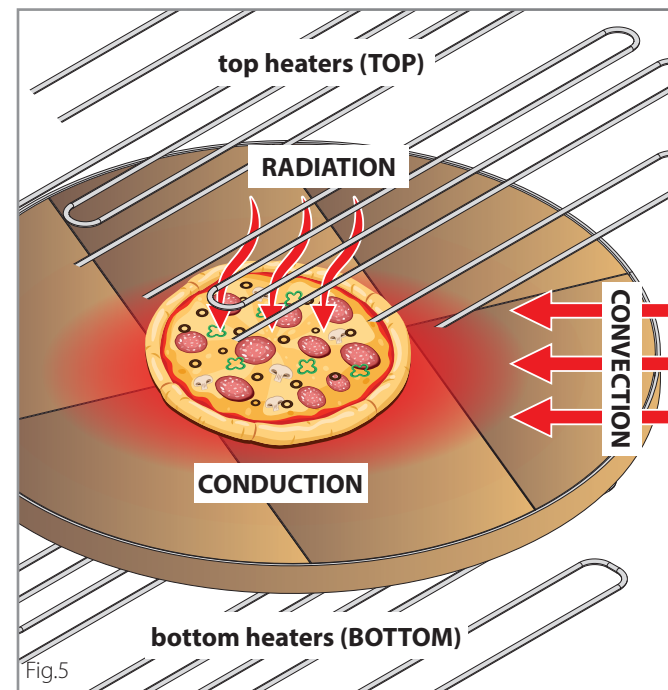

Fig.5

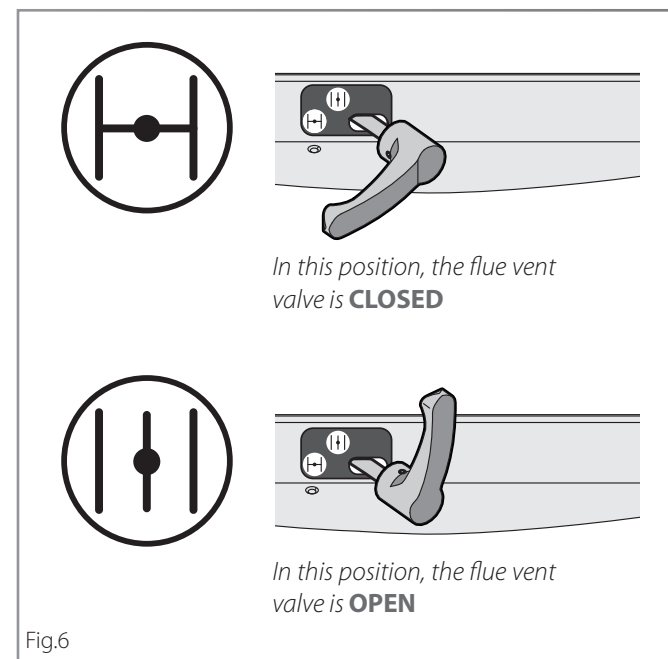

Fig.6

The turntable

The refractory turntable allows cooking pizzas evenly without having to turn them over manually.

To control the turntable, see page [13](#)

Productivity

GIOTTO 110: 60 pizzas/hour

GIOTTO 140: 110 pizzas/hour

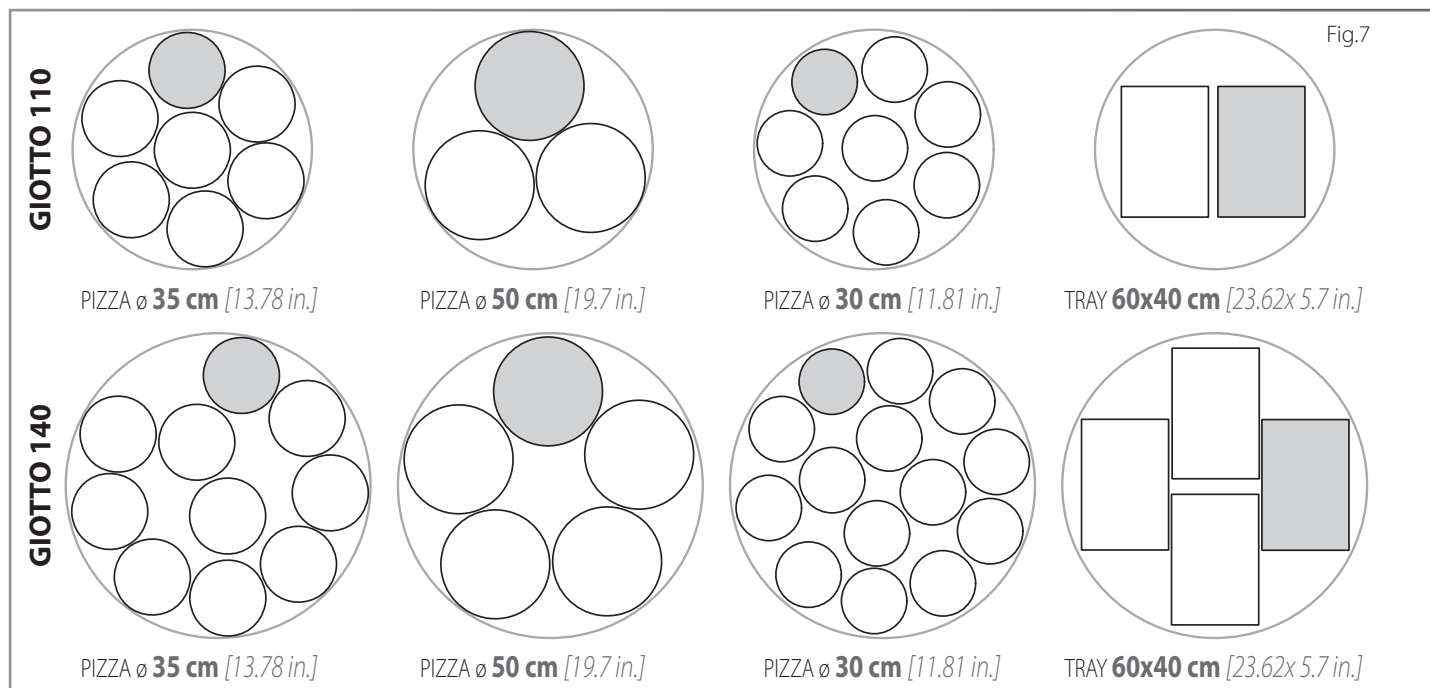
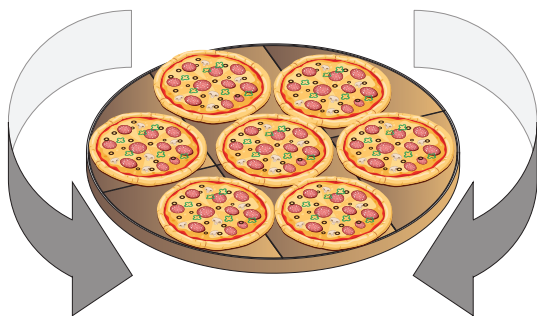

COOKING TABLES

The parameters in the tables are just indicative, since they can vary according to the quantity of work and type of dough to bake (e.g. type of flour, hydration, etc.).

TYPE	Manual stretching					Stretching with Pizzaform					Preheating for both types (Manual stretching or stretching with Pizzaform)
	COOKING					COOKING					
	TIME	TEMP. chamber	% TOP	bottom TEMP.	% BOTTOM	TIME	TEMP. chamber	% TOP	bottom TEMP.	% BOTTOM	
CLASSIC	3 min	320 °C - 608 °F	90%	270 °C - 518 °F	5%	3 min	320 °C - 608 °F	80%	270 °C - 518 °F	0%	time: 1 hour (it may vary according to the percentages set and according to the temperature of the room where the oven is installed) temperature or percentage: the same as the type of pizza During preheating, the flue gas discharge valve must always be kept closed to prevent heat escaping from the chamber and the heating elements being turned on with the consequent overheating of the refractory surfaces which would cause the products to burn.
NEAPOLITAN	90 sec.	360 °C - 680 °F	90%	300 °C - 572 °F	5%	90 sec.	350 °C - 662 °F	90%	300 °C - 572 °F	0%	
DIRECT BAKING TIN	7 min	300 °C - 572 °F	50%	300 °C - 572 °F	60%						
PRE-COOKING TIN	5 min	280 °C - 536 °F	60%	310 °C - 590 °F	40%						
FINISHING TIN	4 min	280 °C - 536 °F	40%	300 °C - 572 °F	60%						
DIRECT PADDLE	6 min	270 °C - 518 °F	70%	285 °C - 545 °F	20%						
PRE-COOKING PADDLE	5 min	280 °C - 536 °F	70%	280 °C - 536 °F	20%						
FINISHING SHOVEL	5 min	270 °C - 518 °F	60%	270 °C - 518 °F	20%						

Contents

Knowing the control panel.....	10
Turntable controls	12
Baking.....	14
Turning the oven on manually.....	14
Setting the preheating.....	14
Entering the recipe parameters manually.....	15
Saving the set parameters.....	16
Using an already stored recipe	17
Special functions: multiselection.....	18
Starting cooking.....	19
Switching the light on (optional)	19
Activating timers	20
Using the recipes.....	22
Using an already stored recipe	22
Creating/saving a new recipe	22
Modifying a stored recipe.....	24
Eliminating a stored recipe.....	24
Duplicating a stored recipe.....	24
Special programs.....	26
MAX program	26
ECO program	27
Programmed switch-on.....	28
Setting an event.....	28
Cancelling a weekly program.....	29
Cancelling an event	30
Modifying an event.....	30
Setting the Note list.....	31
Setting a Holiday	32
Settings.....	33

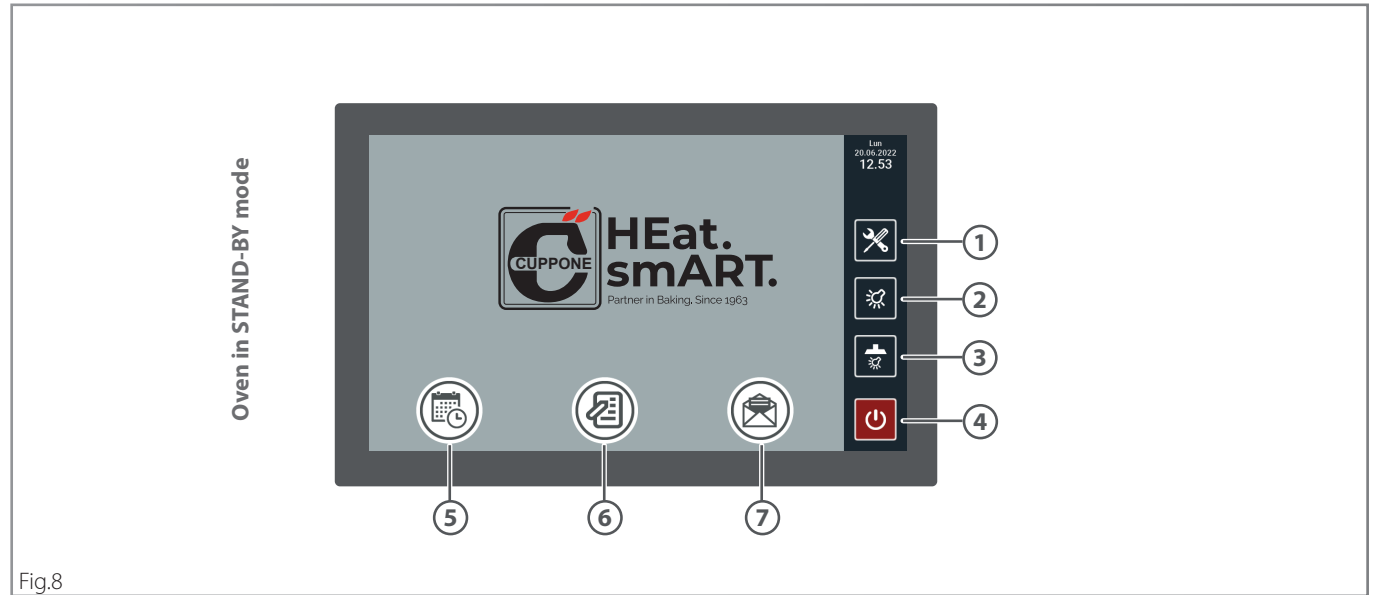

Fig.8

► **Fig.8**
OVEN IN STAND-BY MODE

- SERVICE key (settings)**
Gives access to the user's settings
- Key to switch the CHAMBER LIGHT ON**
switches the light in the cooking chamber on and off
- Hood control key**
allows setting the hood speed and switching its light on
- ON/OFF switch**
Powering the oven on and off
- PROGRAMMED SWITCH-ON key**
Allows accessing the **WEEKLY PROGRAMMED SWITCH-ON** page: it is possible to program the automatic switch-on and -off of the oven for the whole week, up to 4 switch-ons/switch-offs every day
- NOTE LIST setting key**
Gives access to the Note list page, where it is possible to set up to 10 notes that will be displayed at the set time on the set days. Every note can also be repeated cyclically.
- HOLIDAY key**
Gives access to the Holiday page: this function allows interrupting for a certain period of time the oven switching on and off every week, without having to cancel it.

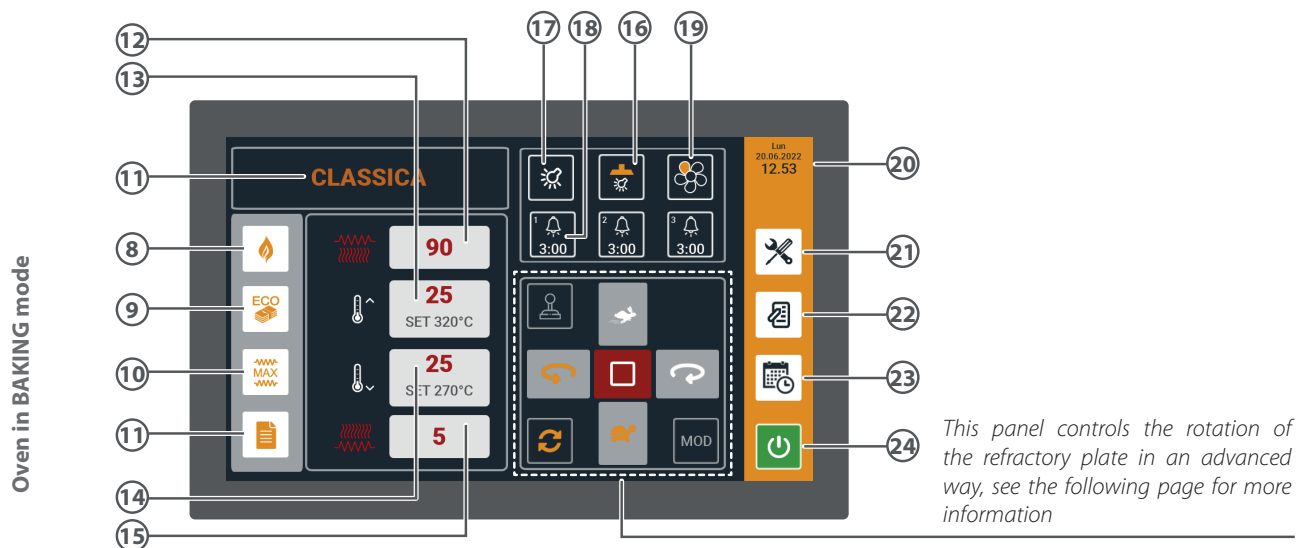

Fig.9

► **Fig.9**
OVEN IN BAKING MODE

- 8 **PYROLYSIS program key**
Starts the pyrolysis program to clean the oven
- 9 **ECO program key**
Starts the ECO program (page 27)
- 10 **MAX program key**
Starts the MAX program (page 26)
- 11 **PROGRAM key**
Allows viewing and using the saved programs
- 12 **Power setting key as a percentage of the TOP heating elements**
- 13 **COOKING CHAMBER temperature setting key**
- 14 **BOTTOM temperature setting key**
- 15 **Power setting key as a percentage of the BOTTOM heating elements**
- 16 **Key TO SWITCH THE HOOD LIGHT ON**
- 17 **Key TO SWITCH THE CHAMBER LIGHT ON**
- 18 **BUZZER key**
Activates an end-of-cooking acoustic signal
- 19 **HOOD SPEED setting key**
- 20 Shows the time and date
- 21 **SERVICE key (settings)**
Gives access to the user's settings
- 22 **NOTE LIST setting key**
Gives access to the **Note list** page, where it is possible to set up to 10 notes that will be displayed at the set time on the set days. Every note can also be repeated cyclically.
- 23 **PROGRAMMED SWITCH-ON key**
Allows accessing the **Weekly programmed switch-on** page: it is possible to program the automatic switch-on and -off of the oven for the whole week, up to 4 switch-ons/switch-offs every day
- 24 **ON/OFF switch**
Powering the oven on and off



! The control panel must be used only with dry and clean fingers.





Controlling the turntable

the turntable can be controlled in two ways: using either the **joystick** or the **control panel**.

► **Fig.10**

To switch the control from one to the other, it is necessary to press the “joystick” button  on the control panel and touch the icon  on the appearing screen.

If the colour of the “joystick” is:

- green  ► **Fig.11** the rotation speed is controlled with the joystick that, moved left or right, makes the plate rotate slowly (turtle mode) or quickly (hare mode). The joystick allows controlling the plate **speed rotation** only.
- white  ► **Fig.12** the rotation of the plate is controlled using the control panel; it allows several advanced settings, listed in the table on the following page.

CONTROLLING THE TURNTABLE WITH THE JOYSTICK

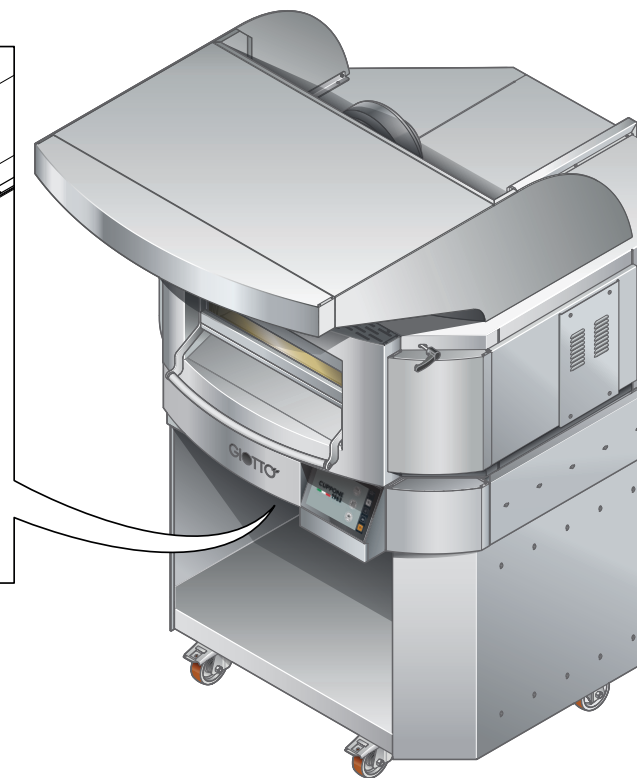
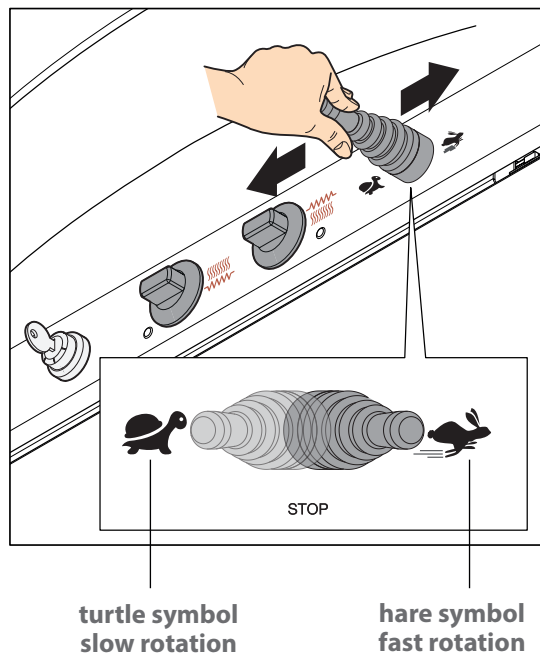
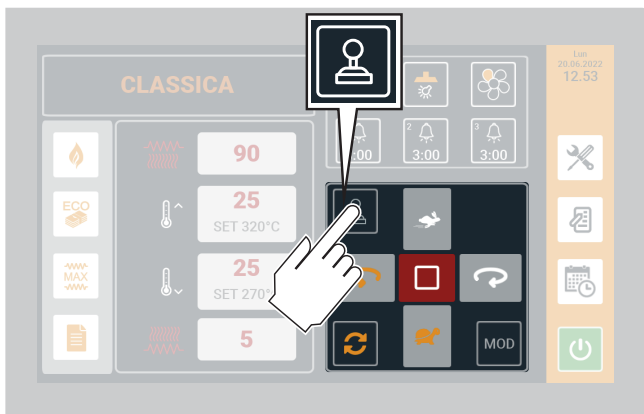
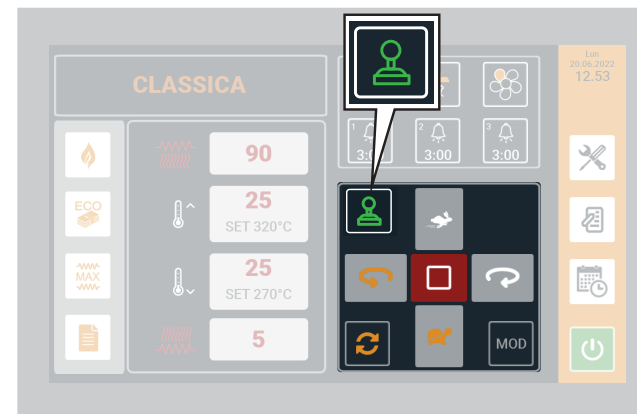

Fig.11

Fig.10 **SWITCHING CONTROL BETWEEN THE JOYSTICK AND THE PANEL**



the rotation of the turntable is controlled using the control panel









the rotation of the turntable is controlled using the joystick

CONTROLLING THE TURNTABLE WITH THE CONTROL PANEL

Fig.12



 	<p>STOP: Stops the plate rotation. Use it only in case of real need; during preheating or cooking, the turntable should rotate continuously to ensure uniform cooking and to preserve the functionality of the oven itself.</p> <p>START: Allows the turntable to rotate with the set settings.</p>	<p>KEY SWITCHING BETWEEN JOYSTICK AND CONTROL PANEL</p> <p>Pressing the key, the control of the rotation of the plate passes from the joystick to the control panel and vice versa.</p> <p>If active (green colour) the plate rotation is controlled with the joystick.</p> <p>If deactivated (white colour) the rotation of the plate is controlled with the control panel.</p>
	<p>CLOCKWISE direction of rotation</p> <p>If active (orange colour), the turntable rotates in a clockwise direction</p>	<p>ROTATION DIRECTION REVERSAL KEY</p> <p>If active (orange colour), the plate rotation direction is automatically reversed based on the time set (to know it, touch the ROTATION DIRECTION REVERSAL key). <i>For example, if the set value is 120s, every 120 seconds the plate reverses rotation from clockwise to anticlockwise.</i></p>
	<p>ANTI-CLOCKWISE direction of rotation</p> <p>If active (orange colour), the turntable rotates in an anti-clockwise direction</p>	<p>The reversal time can be different for each recipe (e.g. for "Classic" it could change every 120 seconds, for Neapolitan every 100 seconds).</p> <p>During a cooking session the reversal time can be set as desired by pressing the ROTATION DIRECTION REVERSAL key. Note however that the change is only temporary, i.e. it only applies to the current session. To make it permanent:</p> <ul style="list-style-type: none"> • save the recipe with the new time setting ► see chapter Saving the set parameters on page 16; or, alternatively • change the recipe settings ► see Fig.25 on page 23).
	<p>HARE MODE fast rotation</p> <p>If active (orange colour), the turntable rotates in fast mode (one complete revolution every 6 seconds)</p>	<p>"MOD" symbol: touching the key displays a numeric keypad that allows changing the rotation times of the mode currently active changing the defaults times. The changes are temporary; the values revert to the default values when the rotation stops. To modify the values permanently, act as explained on page 16 and page 23</p>
	<p>TURTLE MODE slow rotation</p> <p>If active (orange colour), the turntable rotates in slow mode (one complete revolution every 13 seconds)</p>	

Use guided procedure

MANUAL	switching the oven on when it must be used; it is necessary to wait at least an hour for the oven to preheat and reach the right temperature	check the following use procedure (points A , B , C , etc.)
PROGRAMMED	programming the oven switching on and off automatically for the whole	see page 28
AUTOMATIC	with a clock or SMS (with external modules not supplied by the Manufacturer).	check the documentation accompanying the purchased product

A TURNING ON OR OFF THE OVEN MANUALLY

► Fig.13

After powering the oven, the display lights up and shows the **STAND-BY** page.

Pressing the **ON/OFF**  key the display shows the **COOKING** page (the oven always starts with the last recipe used before switching off).

To bring the oven back to stand-by, press the **ON/OFF**  key again.



Careful, when the oven is in stand-by it is still live!

B SETTING THE PREHEATING

Preheating must have the same cooking parameters as the recipe to be used. It must be carried out without products in the cooking chamber and takes about an hour for the oven to be ready for cooking.

IT IS possible to set the preheating in two ways:

- **Fig.14** entering **manually** the desired **chamber and bottom temperature as well as the top and bottom power** (see table **COOKING INFORMATION** on page **9**).
- The entered parameters cannot be stored, so they need to be reset every time. To avoid this operation it is necessary to **save** the manually set recipe (page **16**) or **create** one (page **22**).
- **Fig.16** **starting an already stored recipe**, previously saved by the user.





During preheating, the flue gas discharge valve must always be kept closed to prevent heat escaping from the chamber and the heating elements being turned on with the consequent overheating of the refractory surfaces which would cause the products to burn.



Fig.13

ENTERING THE RECIPE PARAMETERS MANUALLY ▶ Fig.14

- ① Touching the corresponding field, set:
 - the **top power (percentage)**;
 - the **temperature in the cooking chamber**;
 - the **bottom temperature**;
 - the **bottom power (percentage)**;
 - and, if necessary, the **turntable rotation settings**.
- ② An alphanumeric keypad will appear on which the desired valued can be set (see table **COOKING INFORMATION** on page 9).
- ③ Confirm with  or cancel with . After setting these parameters, the oven starts heating straight away in compliance with the set parameters.

During cooking or preheating, if the current temperature in the chamber is:

- **lower** than the one set (so the elements are active), ▶ the icons identifying the top and bottom are **red**.
- **equal to** or **higher** than the set one (so the elements are off), ▶ the icons identifying the top and bottom are **white**.



If the displayed bottom temperature (e.g. 210 °C) is higher than the set temperature (e.g. 150 °C) but the icons are white (elements off), it means that the probe that detects the bottom temperature is affected by the accumulation of heat due to the oven heating. In this case, normally there are no cooking problems.

top power (percentage)

temperature in the cooking chamber

bottom temperature

bottom power (percentage)

plate rotation settings (more information on page 11)

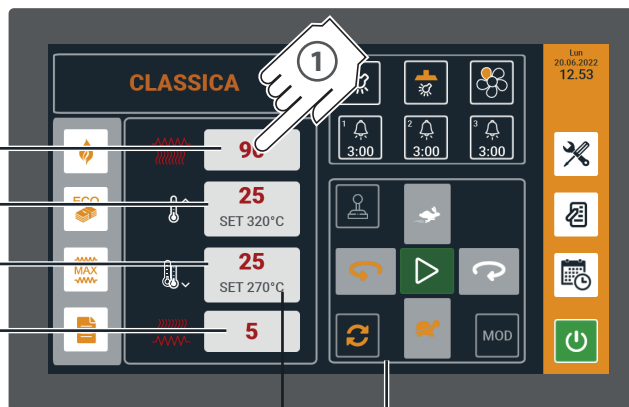

"MANUAL" (at the top) means you are working with parameters set manually.

Fig.14

SAVING THE SET PARAMETERS

► Fig.15

If you wish to save the settings made:

- ① Press the **DISC**  key.
- ② Select whether to **overwrite** the recipe or **save** a copy. If your choice was:

2A OVERWRITE	the recipe <u>Program01</u> will be saved with the set parameters
2B SAVE A COPY	the recipe <u>Program01</u> will keep the original default parameters and a copy will be created, <u>Program01*</u> which will be saved with the new set parameters

- ③ Enter the name of the new recipe.
- ④ Confirm with .

To view and start the saved recipes, follow the explanations in ► **Fig.16**.

Fig.15



WHY SAVING A RECIPE?

To have available a real customized recipe book, easy to access and use. Using an already stored recipe means being able to start cooking with just a few actions, without having to reset the cooking parameters every time: this guarantees maximum functionality and consistent results.

USING AN ALREADY STORED RECIPE

► Fig.16

- 1 Press the **PROGRAM** **1A** key in the display or touch the writing **1B**
- 2 The list of the available recipes is displayed: touch the **NAME OF THE RECIPE** you wish to use (e.g. Napoletana): the oven starts to heat with the relative parameters.
- 3...5 If you wish, you can change the parameters of the selected recipe (e.g. the temperature) as explained in the previous chapter: the changes will affect **only the cooking/preheating in progress** and will not affect the original recipe (temporary effect).

If you wish to modify the recipe permanently, you can do it in two ways:

► See page 22 to change the recipe from the **PROGRAM MANAGEMENT** menu.

► Carry out the operations described in ► Fig.17

- 1 press the **DISC**  key.
- 2 Select whether to **overwrite** the recipe or **save a copy**. If your choice was:

2A OVERWRITE	the recipe <u>Neapolitan</u> will be saved with the set parameters
2B SAVE A COPY	the recipe <u>Neapolitan</u> will keep the original default parameters and a copy will be created, <u>Neapolitan*</u> which will be saved with the new set parameters

- 3 Enter the name of the new recipe.
- 4 Confirm with .

Fig.16



The name of the programs in the figure are just an example (they depend on the names given by the user to his/her recipes)

The name shows which recipe you are using (e.g. Neapolitan). If you change a parameter manually (e.g. the temperature), the wording becomes Neapolitan to show the user's intervention.*

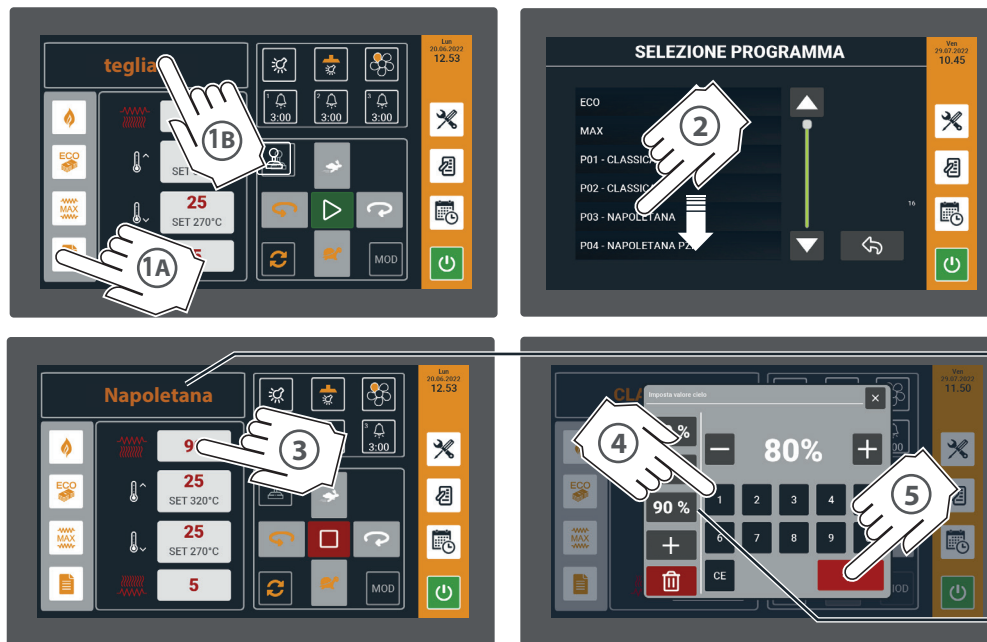
MULTISELECTION: for further details, see page 18

Fig.17

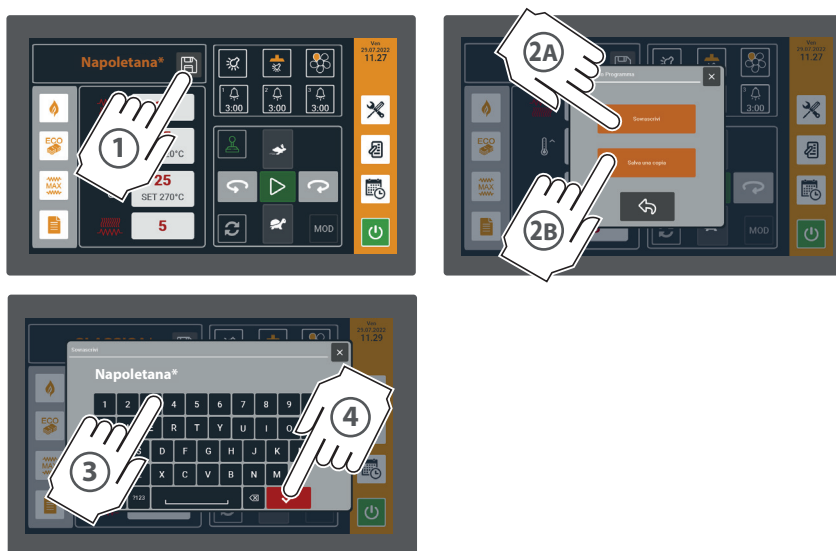

SPECIAL FUNCTIONS: MULTI SELECTION

 The **MULTI SELECTION** function allows creating secondary values so that the recipe setting is quicker and more practical.

In the example of **Fig.18** the left image shows the setting screen if the **MULTISELECTION** function is used, while the right one shows the screen with the traditional view.

In the first case, to set a value, just touch it, in the second the value must be entered using the keypad.

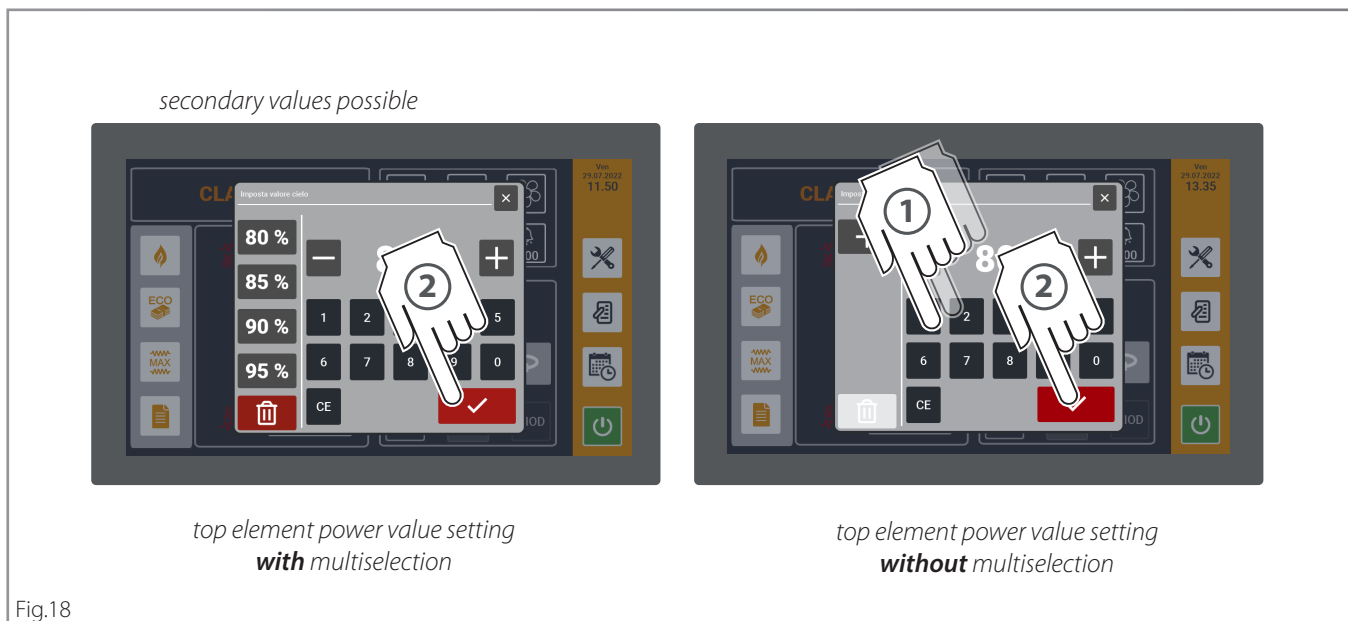



Fig.18

How to set a multi selection **▶ Fig.19**

- ① Touch the desired field.
- ② Touch the + key.
- ③ Enter the desired value; we recommend you set the values you use more frequently.
- ④ Confirm with . It is possible to enter up to 4 secondary values repeating the procedure in paragraph ②.

Not to lose the values entered at the end of the procedure it is necessary to save the changes (see **▶ Fig.15**).

After entering all the values for multi-selection, setting up a recipe will be faster.

You will just need:

- ① To touch the desired field.
- ⑤ Select the desired value among the set ones, touching it will start automatically.



Fig.19

C STARTING COOKING

► Fig.20

Once preheating is complete, you can start cooking and bake the products using personal protection equipment (e.g. gloves) and tools suitable for contact with food and made of material resistant to high temperatures (e.g. steel).

 For optimal results, always adhere to the oven capacity declared by the Manufacturer and position the products to be cooked evenly in the cooking chamber.

During cooking, it is always possible to change any value by (e.g. The temperature) acting as usual.

► Fig.21

The hood can also be checked and set from the cooking window (light on/off and suction speed setting):







	suction off light off		suction on light off
	suction on light on		suction off light on
	minimum suction speed		
	maximum suction speed		

Fig.20

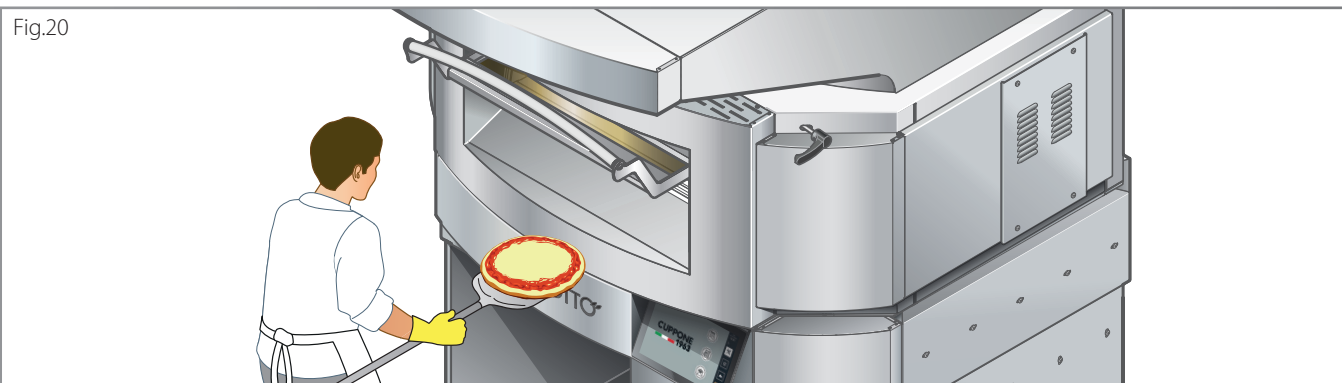
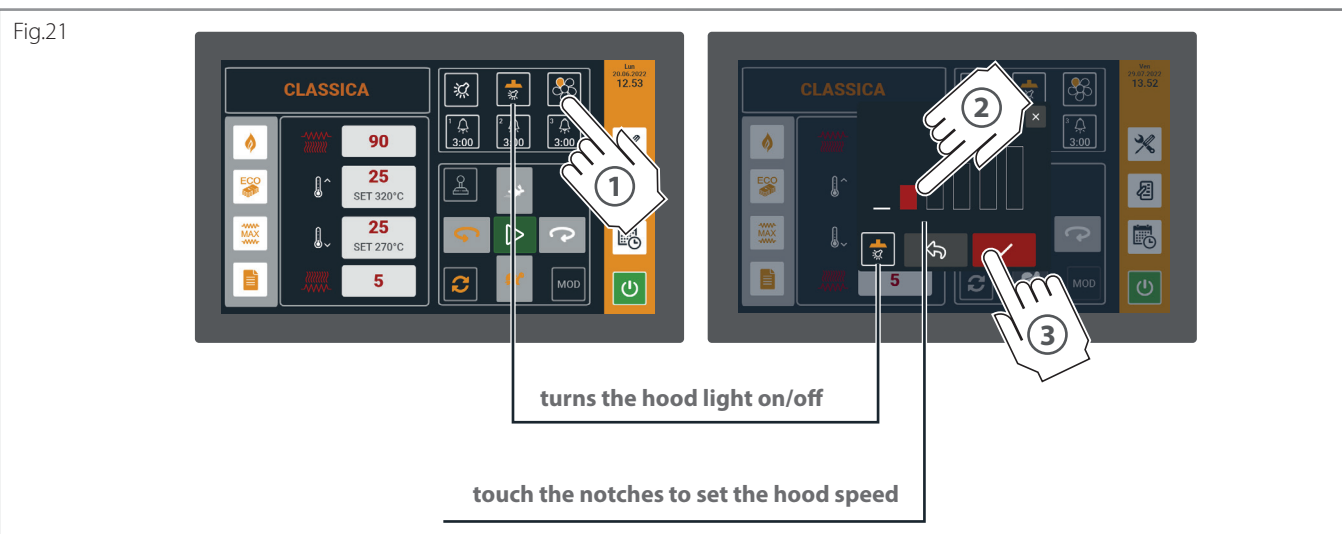

Fig.21



D SWITCHING THE LIGHT ON (OPTIONAL)

► Fig.22

If necessary, the cooking chamber light can be switched on. Touch the same key to switch it off.

Fig.22

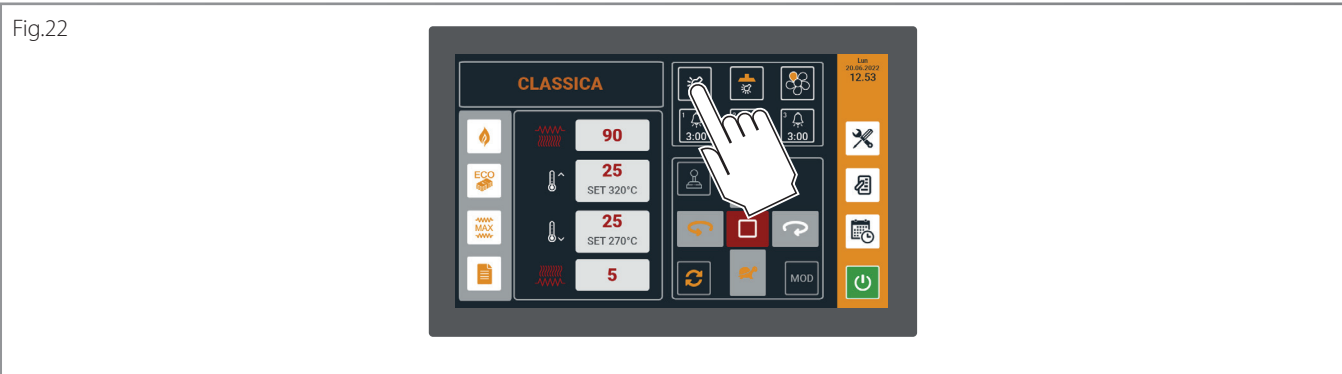



E ACTIVATING TIMERS

If you wish, you can enable up to three timers that will go off when the set time expires. This corresponds to the time you reckon the pizzas will need to cook.

TIMER SETTING

► Fig.23 - setting from display

- 1 Touch the **TIMER**  icon you wish to set (in the example timer 1).
- 2 An alphanumeric keypad will appear on which the desired value can be entered (in minutes: seconds).
- 3 Confirm with  or cancel with .

Repeat points from 1 to 3 to set timers 2 and 3.

TIMER IN PROGRESS

After setting a timer, the countdown starts.

At the end of the time set for each timer:

- the expired timer flashes;
- a buzzer starts (to stop it press the corresponding timer key).

 **Warning: the oven continues heating when the buzzer goes off!**

STOPPING A TIMER IN PROGRESS

Press the icon of the timer  you wish to cancel.

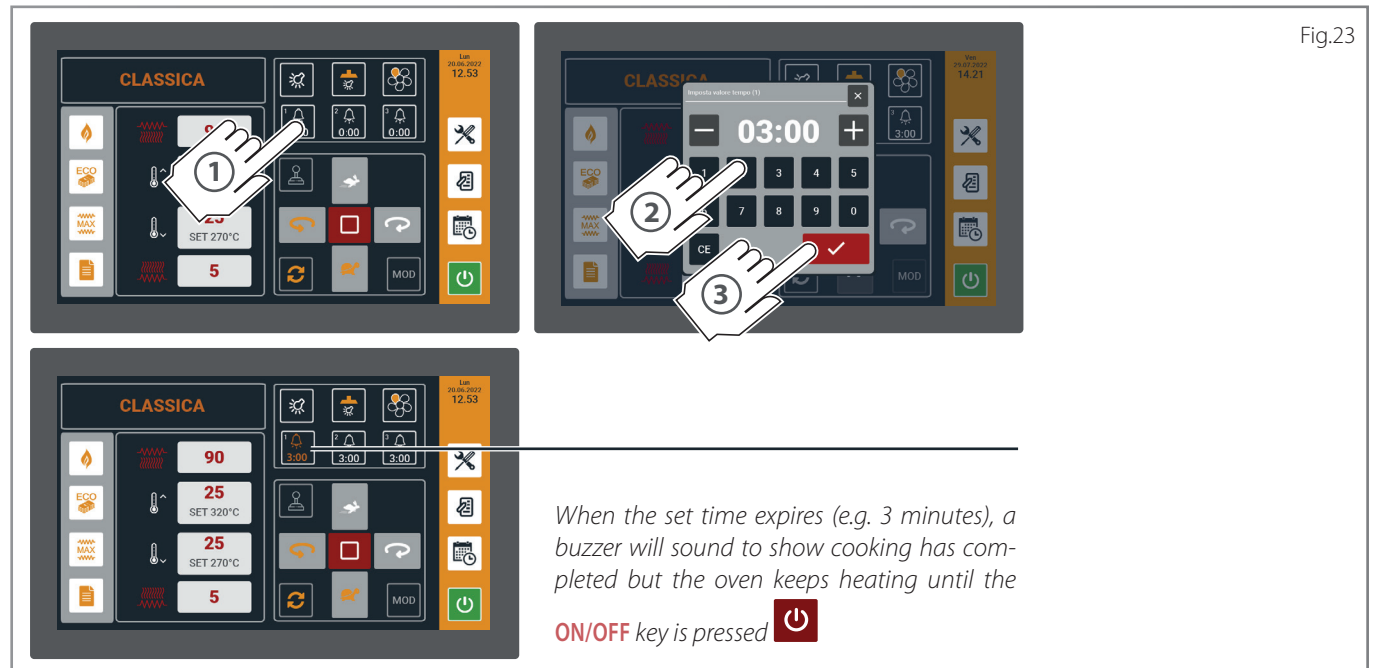



Fig.23

When the set time expires (e.g. 3 minutes), a buzzer will sound to show cooking has completed but the oven keeps heating until the

ON/OFF key is pressed 

IS THE OVEN TIME OR DATE WRONG?

On first switch-on or after a sudden or prolonged switch-off period, the oven date or time may be wrong: go to the "SERVICE/DATE AND TIME" section to enter the correct values.

 See page [33](#)

Using the recipes

Saving a recipe means you can reuse it without having to reset its cooking parameters.

Moreover, by giving it a name (e.g. Neapolitan), it can be easily found and quickly started.

USING AN ALREADY STORED RECIPE

► Fig.24

To use an already stored recipe, just:

- 1 Press the **PROGRAM** key in the 1A display or touch the writing 1B.
- 2 The list of the available recipes is displayed: touch the **NAME OF THE RECIPE** you wish to use (e.g. Neapolitan): the oven starts to heat with the relative parameters.
- 3...5 If you wish, you can change the parameters of the selected recipe (e.g. top percentage) as explained in the previous chapter: the changes will affect **only the cooking in progress** and will not affect the original recipe (temporary effect).

CREATING/SAVING A RECIPE

► Fig.25

A recipe can be **saved** while cooking is in progress (see ► Fig.15 chap. **Saving the set parameters**) or **created** from the **PROGRAM MANAGEMENT** menu, following the instructions below:

- 1 Touch the **SERVICE** icon (with the oven in stand-by).
- 2 Touch the **PROGRAM MANAGEMENT** icon.
- 3 Touch the **NEW PROGRAM** key.
- 4 Assign **a name to the recipe** (in the example "Classic"): in this way it will be easy to recognize the one you need; Confirm with **✓** or cancel with **CE**.
- 5 Setting the cooking parameters:
 - the cooking **parameters**:
 - the turntable rotation **parameters** 6

The name of the programs in the figure are just an example (they depend on the names given by the user to his/her recipes)

The name shows which recipe you are using (e.g. Neapolitan). If you change a parameter manually (e.g. the temperature), the wording becomes Neapolitan* to show the user's intervention.

If **secondary values** have been set during the creation of the recipe, they appear as possible alternative shortcuts (e.g. 20%, 30%, 40%). Pressing the + key allows you to set them even before using the recipe, in this case, however, they will only affect the cooking in progress and will not modify the original recipe (temporary effect).

Clears secondary values selectively

Fig.24

- For correct filling out it is necessary to enter:
- the **main value** ► default value with which the recipe starts;
- **secondary values** ► values that, while cooking, can be quickly selected as an alternative to the main default one (for instance see ► Fig.21).

Confirm with **✓** or cancel with **CE** the entries made.

- 7 If necessary, you can set up to 3 **timers** which will be activated at the end of the set time (optional). The procedure for entering the time is the usual one. Confirm with **✓** or cancel with **CE**.
- 8 Save the recipe with the **DISC**  symbol.

 To modify the original recipe permanently, see page 24.



RECIPE NAME

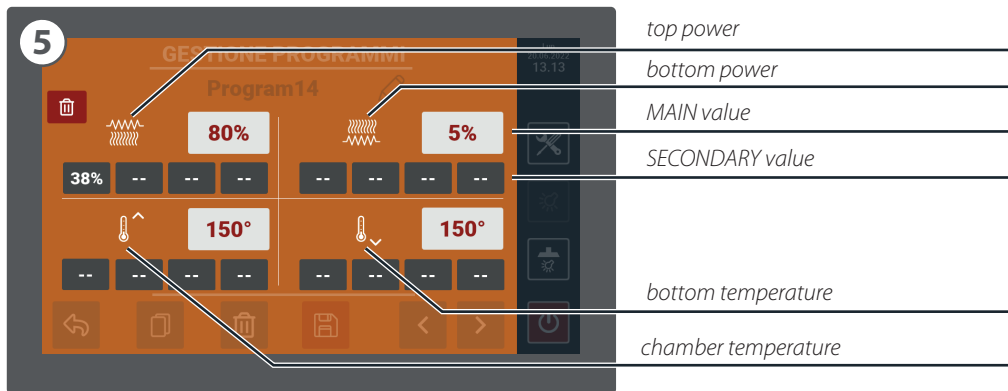

top power
bottom power
MAIN value
SECONDARY value
bottom temperature
chamber temperature

SETTING PARAMETERS



TIMER SETTING

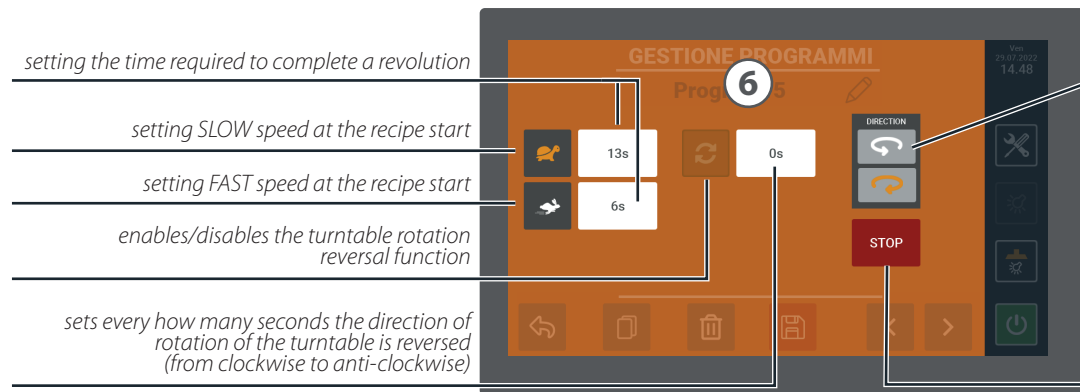

Anticlockwise or clockwise rotation of the turntable at the start of the recipe

STOP: the recipe includes the turntable rotation

START: the recipe does NOT include the turntable rotation. Block the turntable only in case of real need; during preheating or cooking, the turntable should rotate continuously to ensure uniform cooking and to preserve the functionality of the oven itself.

In the example on the side when the recipe starts:



- the turntable will turn at SLOW speed (15 seconds to make a complete turn),
- the rotation will be anticlockwise
- turntable rotation is enabled (STOP)
- the function of automatic reversal of the direction of rotation is enabled and occurs every 30 seconds

WHITE ICON: function disabled
ORANGE ICON: function enabled

TURNTABLE SETTINGS

MODIFYING A STORED RECIPE

► Fig.26

- ① Touch the **SERVICE** icon (with the oven in stand-by).
- ② Touch the **PROGRAM MANAGEMENT** icon.
- ③ Touch the **NAME** of the recipe you wish to modify (in the example "Classic").
- ④ Change the values as usual. Confirm with  or cancel with  the entries made.
- ⑤ Save the recipe with the **DISC**  symbol.

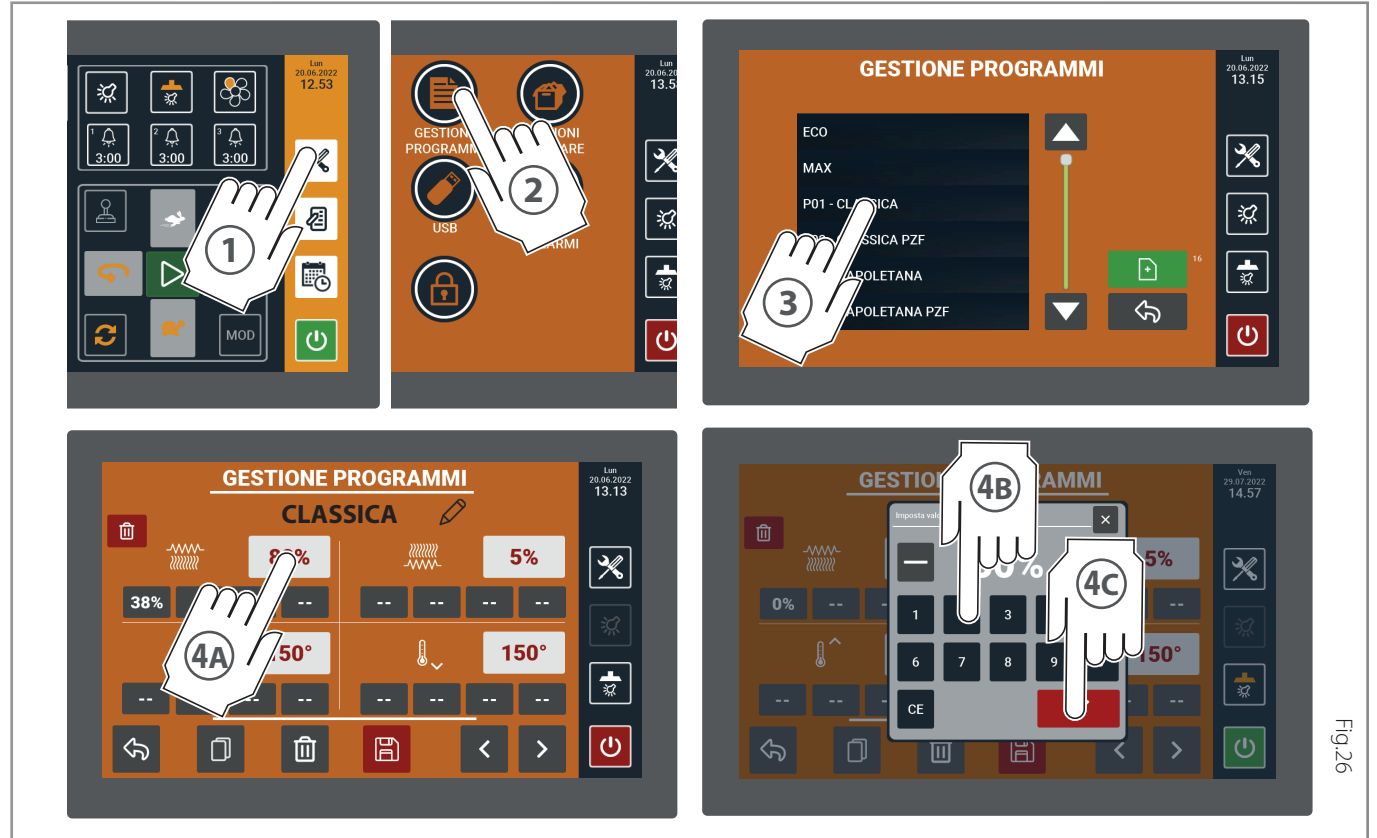

ELIMINATING A STORED RECIPE

► Fig.27

- ① Touch the **SERVICE** icon (with the oven in stand-by).
- ② Touch the **PROGRAM MANAGEMENT** icon.
- ③ Touch the **NAME** of the recipe you wish to delete (in the example "Classic").
- ④ Touch the **BASKET**  symbol:
 - the basket **4A** allows to delete the parameter values selectively;
 - the basket **4B** deletes the recipe after the decision has been confirmed **4C**.



DUPLICATING A STORED RECIPE

- ① Touch the **SERVICE** icon (with the oven in stand-by).
- ② Touch the **PROGRAM MANAGEMENT** icon.
- ③ Touch the **NAME** of the recipe you wish to duplicate, for instance **CLASSIC**.
- ④ Touch the  key; a new recipe is created with the name of the starting recipe and a final (01), for instance **CLASSIC (01)**; it can be changed as you wish, while the starting recipe **CLASSIC** will keep its original parameters.

Fig.26

Fig.27



MAX program

The **MAX** program is used to quickly raise the temperature of the cooking chamber and the refractory surface when the user realizes that they are too low for his needs.

Default values of the MAX program

- **duration:** 1 minute
- **temperature:** increase of 30 °C - 86 °F over the chamber temperature (offset)
- **power:** top and bottom at 100%

STARTING THE PROGRAM

- 1 To start the program, touch its symbol .
- 2 A screen appears that allows you to:
 - 2A **start the program** by pressing the  key: in this case the program will last 1 minute (default duration)
 - 2B **set the duration of the program** by entering the desired time (e.g. 4:30 minutes) and then 2C start it by pressing the  key.
- 3 A summary screen appears: touching the **TOP** or **BOTTOM** field it is possible to set the power at **100%** or at **0%** (it is not possible to set powers other than these two values). The entered values are **temporary**, that is they apply only to the **MAX** program in progress; to modify its values **permanently** act as explained on page 23.

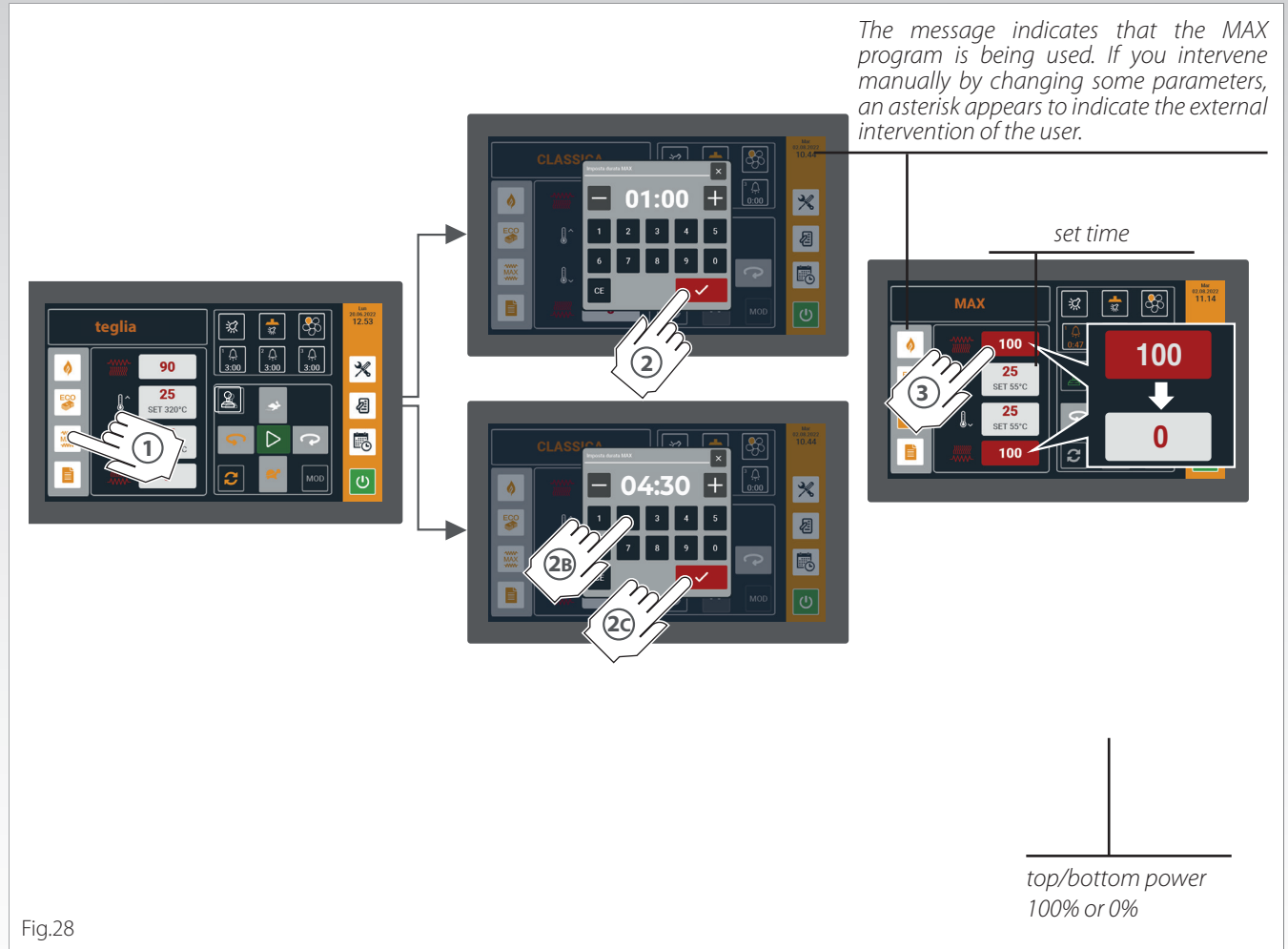



Fig.28

PROGRAM END

The program ends:

- When the  key is pressed.
- When a different program is selected.
- When the oven is switched off.
- At the end of the default time (1 minute) or that set by the user (for example 4:30 minutes) the buzzer sounds and you return to the program that was active before starting the **MAX** program.

ECO program

The **ECO** program is used to preserve the functionality of the oven when it is NOT working.

Default values of the ECO program

- **temperature:** 280 °C -536 °F
- **power:** top 45% and bottom 0%

STARTING THE PROGRAM

- 1 To start the program, touch the  symbol.
- 2 Open the chimney to avoid overheating the stone.
- 3 The program set by the manufacturer will start automatically, allowing constant maintenance of the temperature in the chamber, energy-saving and no overheating of the bottom.

PROGRAM END

The program ends:

- When the  key is pressed.
- When a different program is selected: the oven will return to the previous settings and will return to the set temperature in a short time.
- When the oven is switched off.

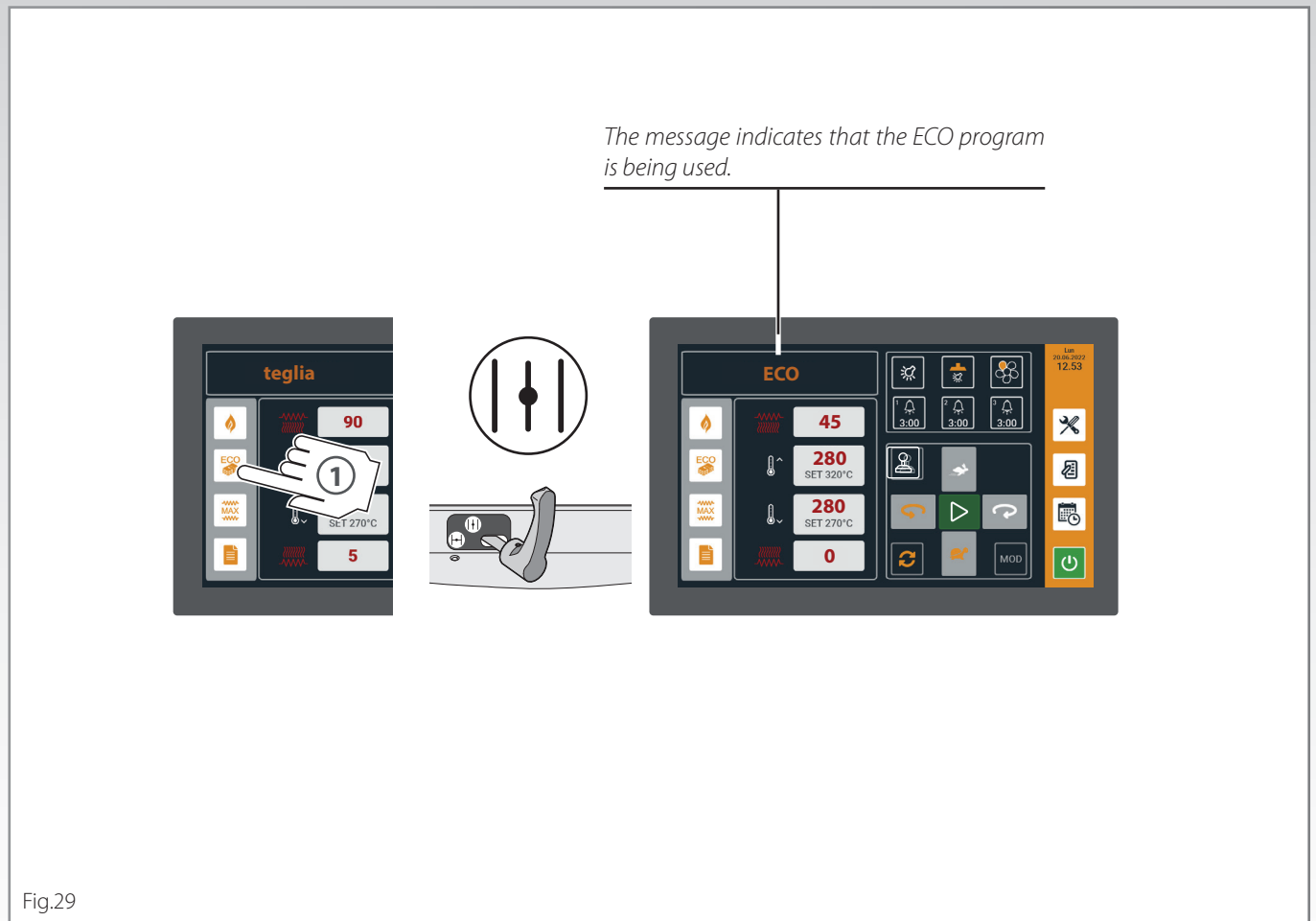

Fig.29

Programmed switch-on



The programmed switch-on function is very useful because the oven can be already hot, and therefore ready to bake, when the restaurant is opened.

With this function, you can program **the oven switching on and off automatically** for the whole week.

IT IS possible to program up to a maximum of **4 events** a day (that is 4 daily switch-ons and switch-offs).

SETTING AN EVENT

► Fig.30

1 Touch the **PROGRAMMED SWITCH-ON** icon.

2 touch a white rectangle

3 4 set the details, choosing:

the oven **switch-on** time

the oven **switch-off** time

the **programme** the oven has to start with

the **days** the programmed event must take place
orange day = an event is planned (programmed switch-on or switch-off)
grey day = no event is programmed

5 Confirm with

6.....13 If necessary, program the following events repeating the same procedure.

Fig.30



Event 1: on Mondays, Tuesday and Fridays, the oven will switch on at 11:00 in the morning and switch off at 14:00 with the "NEAPOLITAN" recipe.

Event 1: on Saturdays and Sundays the oven will switch on at 11:00 in the morning and switch off at 15:00 with the "CLASSIC" recipe

Event 2: the oven will switch on every evening at 18:00 in and switch off at 23:30 with the "NEAPOLITAN" recipe.

► Fig.31



- At the end of the settings it is necessary to make the weekly function operational by moving the cursor to the right so that it turns green and the number **1**  is displayed.

 0 grey icon	<ul style="list-style-type: none"> ▶ the weekly programmed switch-on mode is inactive (which remains set anyway); ▶ the user's manual (non-automated) switch-on mode is active;
 1 green icon	<ul style="list-style-type: none"> ▶ the weekly programmed switch-on mode (based on the details set) is active

- Confirm the entered details with .

CANCELLING A WEEKLY PROGRAM

► Fig.32

- Touch the **PROGRAMMED SWITCH-ON** icon.
- Disable the programming by moving the slider to the left so that it turns grey and **0**  is displayed.
- Confirm your selection with .

From now on, the oven must be switched on/off manually by the user.

The previous programming however remains in the memory; to reactivate it, simply move the cursor back to the right so that it turns green and **1**  is displayed.

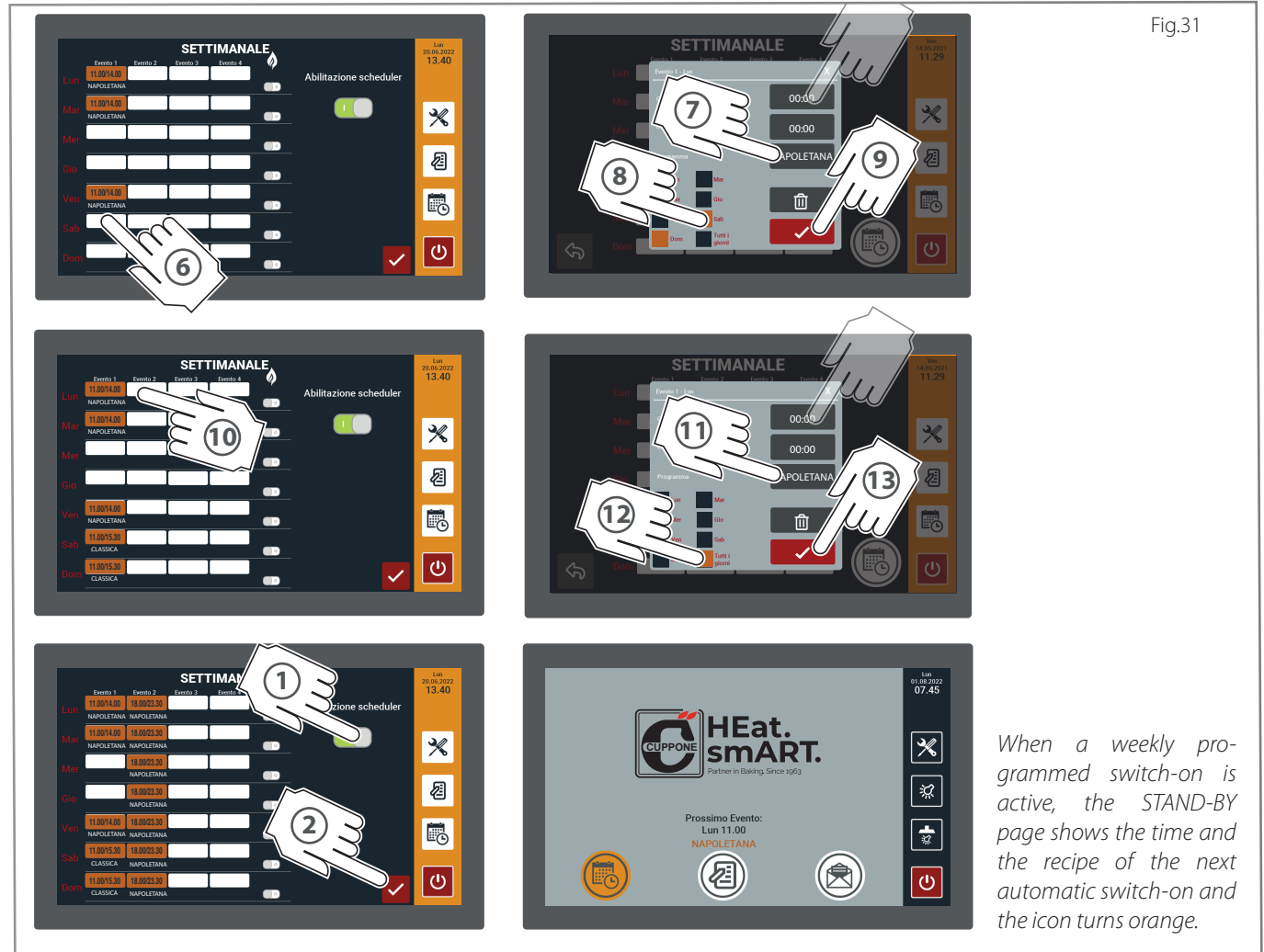

Fig.31

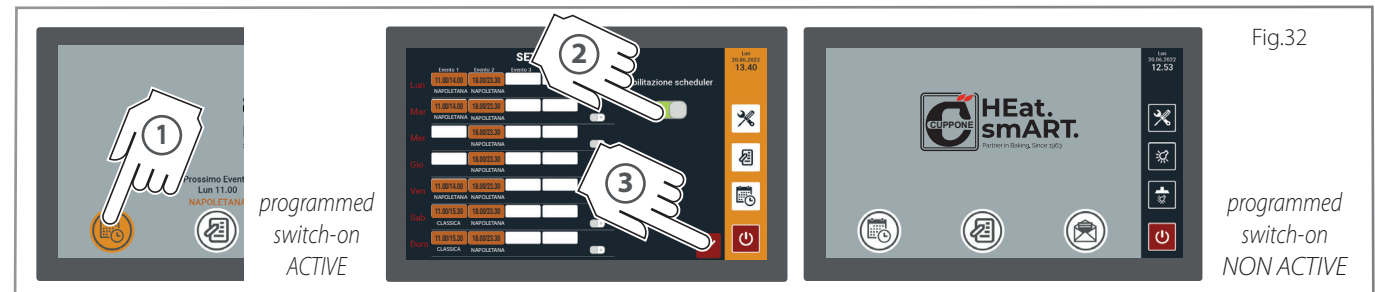

Fig.32

When a weekly programmed switch-on is active, the STAND-BY page shows the time and the recipe of the next automatic switch-on and the icon turns orange.

programmed switch-on ACTIVE

programmed switch-on NON ACTIVE

CANCELLING AN EVENT

► Fig.33



- 1 Touch the **PROGRAMMED SWITCH-ON** icon.
- 2 Touch the event you wish to delete.
- 3 Touch the **BASKET**.
- 4 Confirm your choice with .
- 5 Exit the programmed function with .

Fig.33



In this example, the event that provided for switching on at 18:00 and switching off at 23:30 on Wednesday has been cancelled.

All other events remain active and scheduled.

MODIFYING AN EVENT

► Fig.34





- 1 Touch the **PROGRAMMED SWITCH-ON** icon.
- 2 Touch the event you wish to modify.
- 3 Touch the parameter you wish to modify (event start or end time, recipe with which the oven must switch on).
- 4 Enter the desired values.
- 5 Confirm your choice with .
- 6 7 Exit the programmed function with .

Fig.34

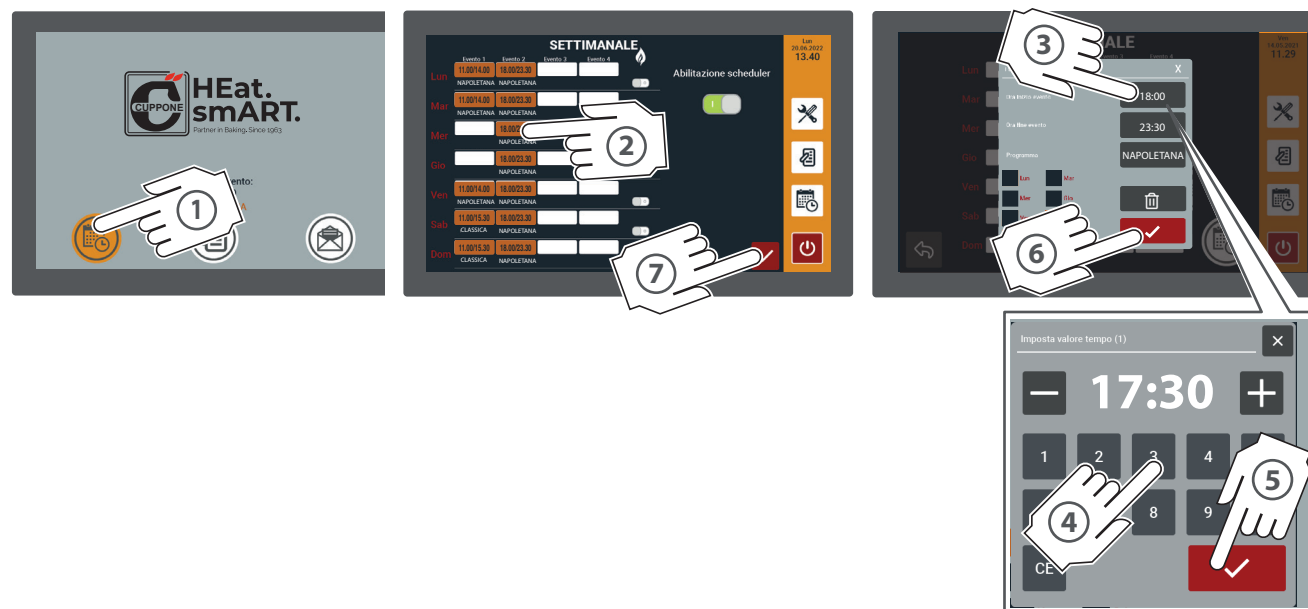

Setting the Note list

 The note list function allows setting up up to 10 notes that will be displayed at the set time and on the set days. Each note can have up to 200 text characters and it is possible to program when the note will expire or has to be repeated (e.g. "Buy mozzarella" to be repeated every month).

► Fig.35

To create a new note (or modify an existing one):

- enter the **text** (that is what must be displayed)
- enter its **expiry date** (that is when it must be displayed)
- enter when it has to be **repeated** (that is how often it must be displayed):
 - **do not repeat:** the note is displayed on the expiry date and not repeated,
 - **every day:** the note is displayed and then repeated the following day,
 - **every month:** the note is displayed and then repeated the following month. If the following day of the month does not exist (e.g. 29 February), it is reproposed the first month when that day exists (e.g. the note is reproposed on 29 March),
 - **every year:** the note is displayed and then repeated the following year.

If the oven is not powered, when it is switched back on all the expired notes will be displayed.

By selecting a note, you can modify it or delete it with the two keys shown.

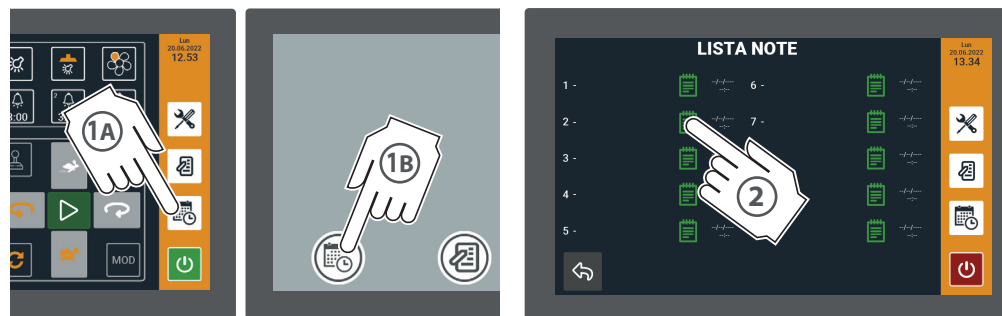
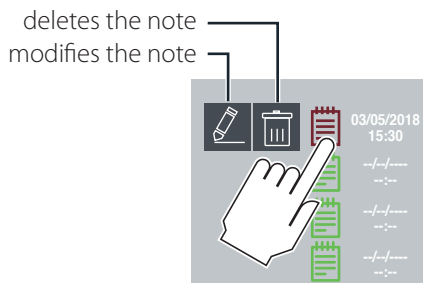

Entering the note text

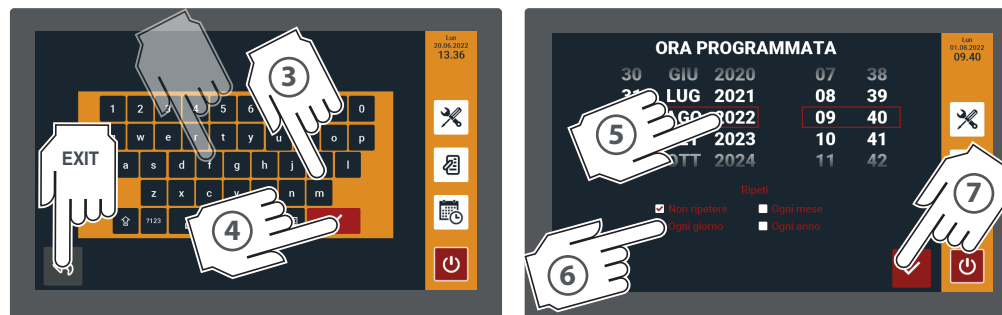

Entering the expiry (date and time) and note repetition

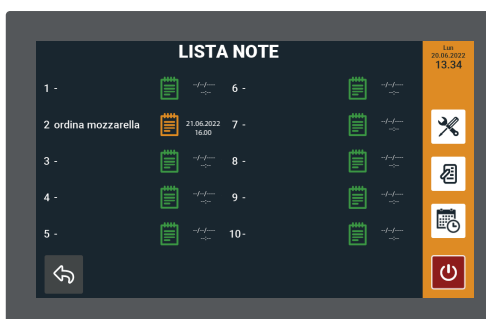

To make the pop-up warning disappear, just touch it.

The colour of the icon shows the note status:





-  note not programmed, therefore free
-  Note programmed and not yet expired (still to be displayed)
-  Note programmed and expired (already displayed)

Fig.35

Setting a Holiday

If enabled, the function:

- **stops the weekly switch-on and -off program** (page 26), if present, until the set time and date, without having to delete it: this is useful if the restaurant is closed for holidays and therefore the oven must not switch on during that period;
- **displays** a message if you try and switch the oven on manu-

ally with the **ON/OFF**  key: this prevents accidental switch-ons, for instance during cleaning carried out during the closure period.

► Fig.36

- 1 Touch the **HOLIDAY** icon.
- 2 Set the details, choosing:
 - the **end date** of the holiday (e.g. 29/07/2021)
 - the **end time** of the holiday (e.g. 03:45).
- 3 At the end, make the weekly function operational touching the icon in the bottom RH corner.

If it is:

white = the holiday function **is not active** but is programmed

orange = the holiday function is **active** (oven in stand-by until the set time/date). The main screen displays the message “Holiday mode active until” with the set time/date.

From that moment until the set time/date the weekly switch on/off function is disabled.

In this situation (orange icon = active function) it is not possible

to switch on the oven with the **ON/OFF**  key; to be able to switch it on manually, it is necessary to disable the Holiday function (see ► [Fig.37](#)).

Fig.36



Insertion of date and time of the **end** of the holiday and **activation** of the function

Fig.37

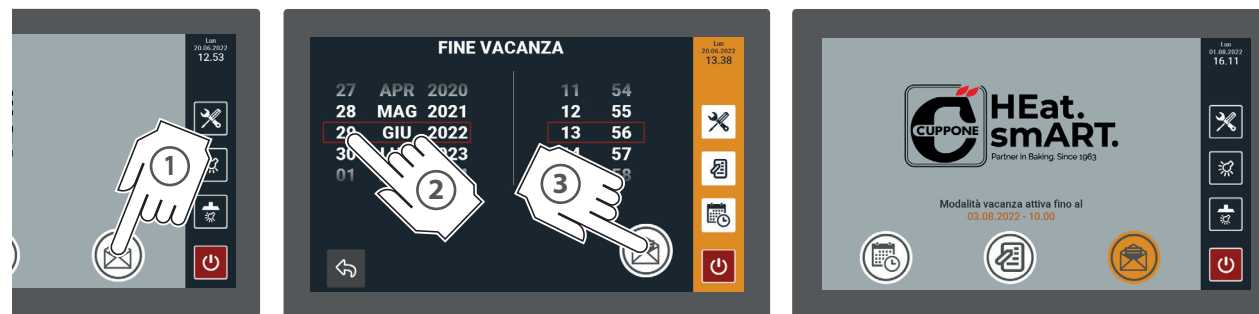

Settings



The **SETTINGS** section is dedicated to three different persons: the user, installer and maintenance technician.

! To prevent unauthorized people from accessing the programming of the parameters that, if incorrectly set, may affect the use of the oven, some menus are protected with a password supplied specially by the Manufacturer.

DATE AND TIME

► Fig.38

In this section, the current date and time can be set.

- 1 Touch the **SERVICE** icon.
- 2 Touch the **DATE AND TIME** icon.
- 3 Set the current date touching the arrows
- 4 Set the current time touching the arrows
- 5A Set the **automatic passage to summer time** (DST - daylight saving time)
 - **Europe:** summer time starts the last Sunday in March at 2:00, winter time starts the last Sunday in October at 3:00;
 - **United States:** summer time starts the second Sunday in March at 2:00 a.m.; winter time starts the first Sunday in November at 2:00 a.m.
- 5B Set the **GMT (Greenwich Mean Time)** choosing the geographical area your country belongs to (e.g. for Italy: GMT +1 Central Europe).
- 6 At the end of the settings, confirm with  or cancel with .

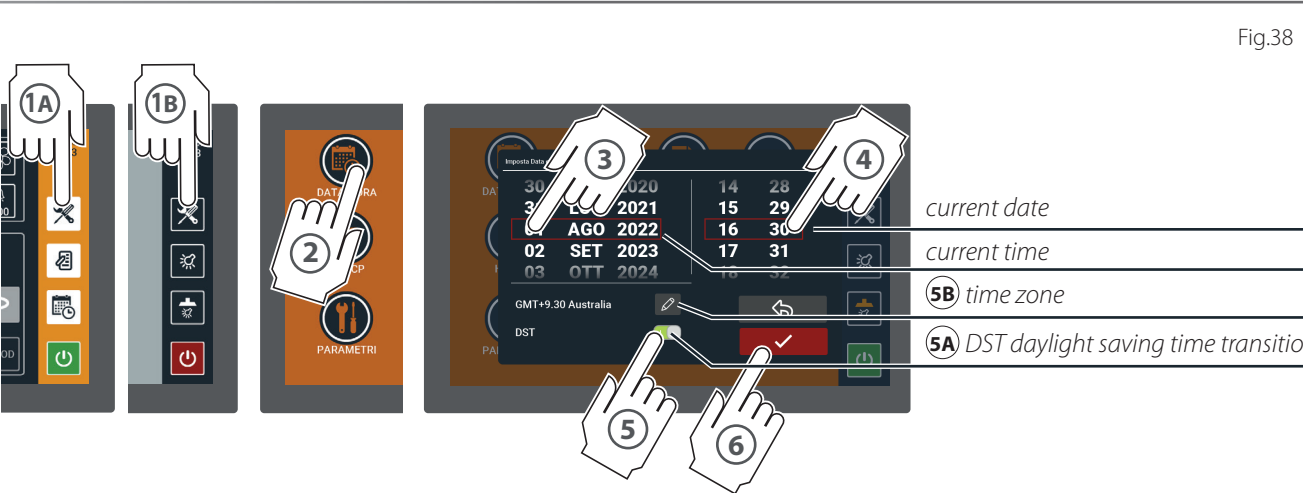

Fig.38

current date

current time

5B) time zone

5A) DST daylight saving time transition

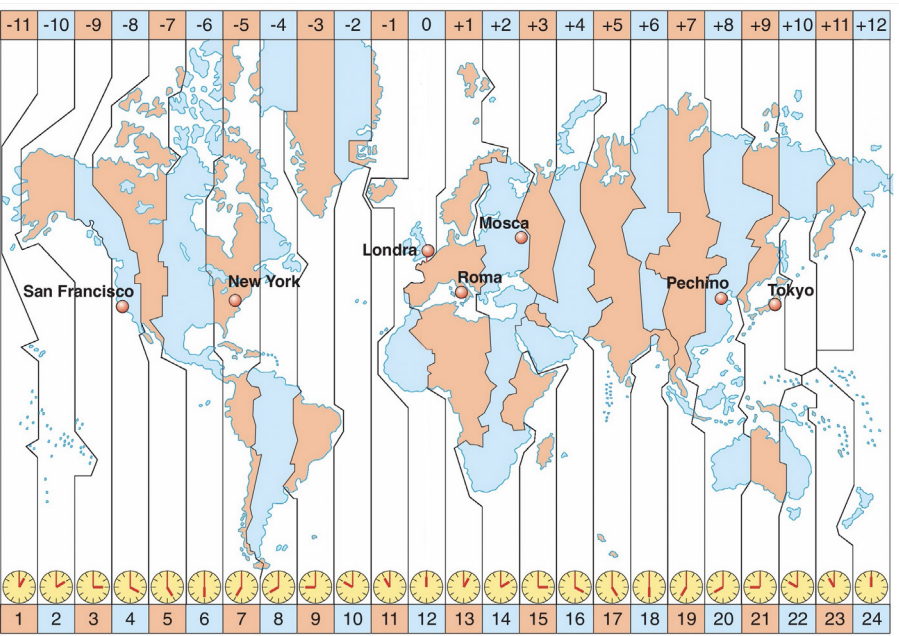

◀ GMT



Time variation based on the geographic area the country belongs to

Time zones in the world divided into geographical areas

LANGUAGE

► Fig.39

In this section you can set the language used in the menu displays: the active language is highlighted in red.

- 1 Touch the **SERVICE** icon.
- 2 Touch the **LANGUAGE** icon.
- 3 Touch the desired language; the languages currently available are: English, Italian, French, Spanish, German, Russian and you can scroll through them with the arrows
- 4 At the end of the settings, confirm with  or cancel with .

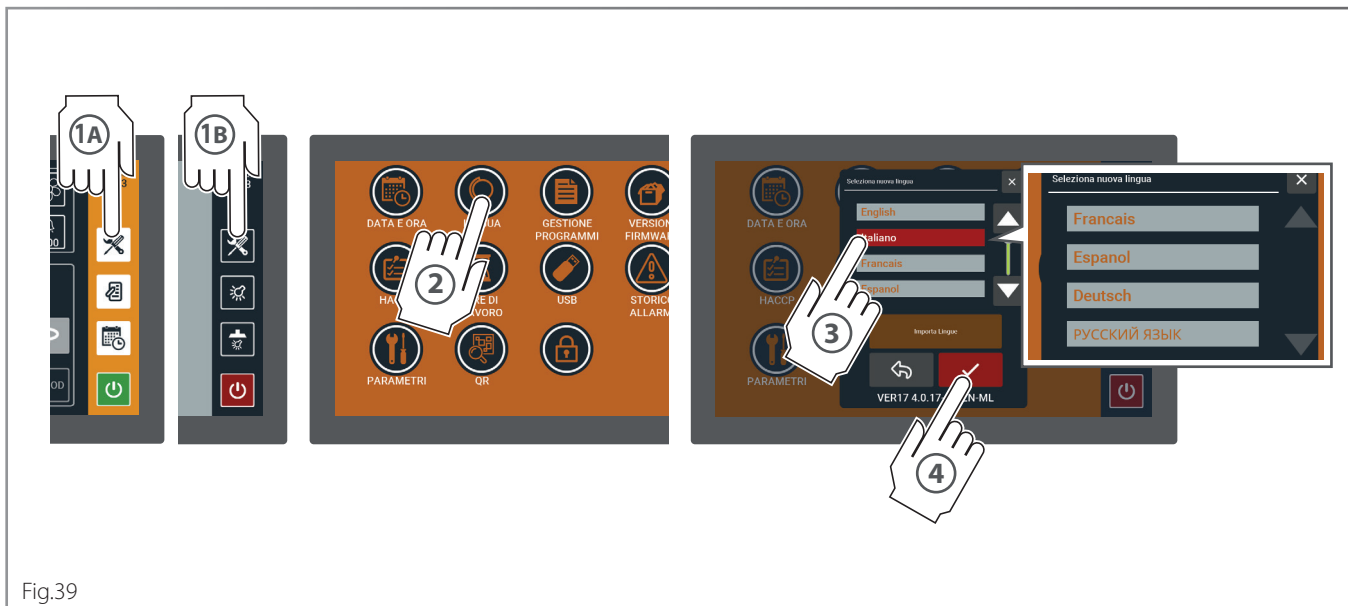



Fig.39

Program management

In this section you can save a recipe: this means you can reuse it without having to reset its cooking parameters. Moreover, by giving it a name, it can be easily found and quickly started.

 See page [22](#)

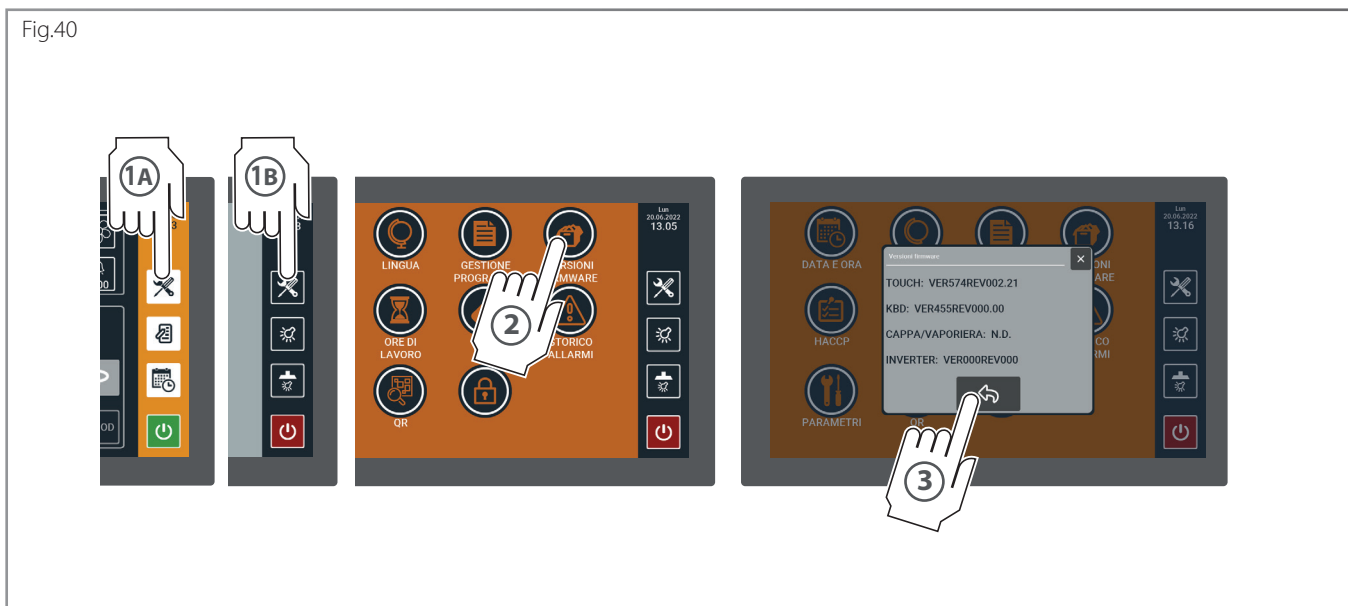



Fig.40

FIRMWARE VERSIONS

► Fig.40

In this section you can come to know the firmware version installed on the oven and other data about it.

- 1 Touch the **SERVICE** icon.
- 2 Touch the **FIRMWARE VERSION** icon.
- 3 At the end of the display, exit the screen with .

HACCP

Section not accessible to the user, reserved to qualified personnel.

WORKING HOURS: RESETTING THE MAINTENANCE HOURS (COUNTER RESET)

A counter inside the oven counts the work hours carried out; after a certain number of hours, a pop-up appears on the display that warns about the need to carry out maintenance on the oven. After carrying out the required operation (for example cleaning under the stones), it is necessary to restart the working hours count from zero, resetting the counter.



1

Touch the warning screen to continue with the operation.

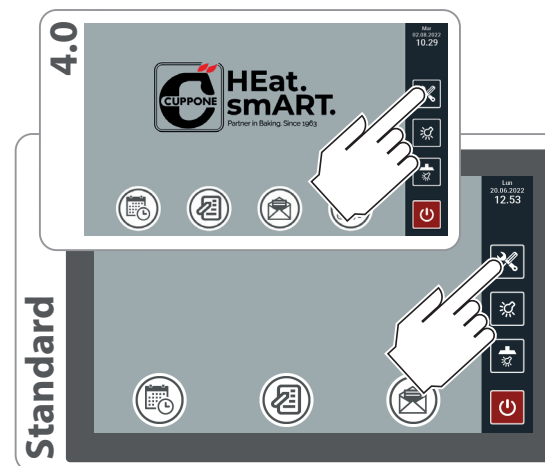

2

With the oven in stand-by, touch the **SERVICE** icon.

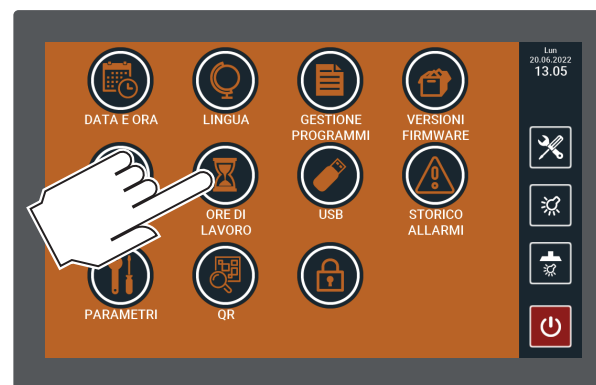

3

Touch the **WORK HOURS** icon.



4

Touch the **BASKET** icon next to "Hours since last maintenance: 5* (h)"

* the shown number is just an example

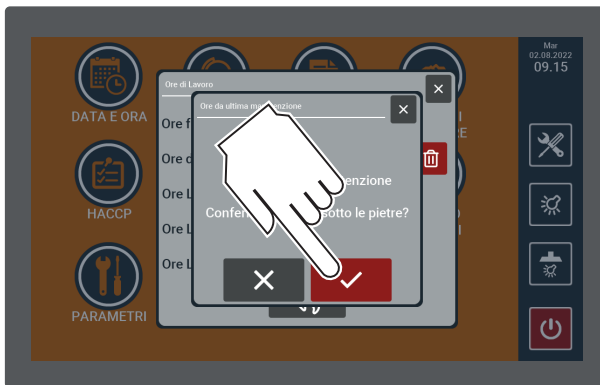

5 Touch the  key to confirm the reset of the maintenance hours (hour counter reset).

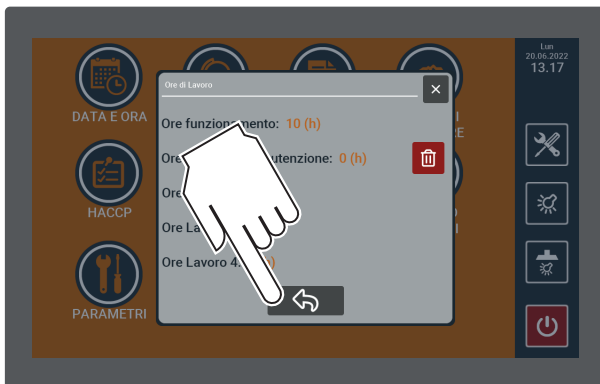

6 Touch the **BACK ARROW** icon or wait a few seconds to exit the screen.



7 Touch the **SERVICE** icon to return to the stand-by screen.

5 MAINTENANCE AND CLEANING

Warnings

! Before any cleaning, it is necessary to **switch off the power** to the appliance (acting on the system switch) and wear suitable personal protection equipment (e.g. gloves, etc.). The user must carry out only routine maintenance, for extraordinary maintenance, contact a Service Centre requesting service from an authorised technician. The Manufacturer warranty does not cover damages due to negligent or incorrect maintenance or cleaning (e.g. use of unsuitable detergents).

! **Any cleaning must be carried out with the oven completely cold and wearing adequate personal protection devices (e.g. gloves, etc.).**

When cleaning any part or accessory do NOT use:

- abrasive or powder detergents;
- aggressive or corrosive detergents (e.g. hydrochloric or sulphuric acid, caustic soda, etc.). Caution! Never use these substances also when cleaning the substructure/floor under the appliance or its base;
- abrasive or sharp tools (e.g. abrasive sponges, scrapers, steel brushes, etc.);
- steamed or pressurised water jets.

! *It is best to have a Service Centre perform maintenance and inspection on the appliance at least once a year to ensure top working and safety conditions.*

Keep the vents of the electrical compartment clean and clear.



Oven cleaning

CLEANING THE EXTERNAL STEEL PARTS

Use a cloth dampened with hot soapy water and end with rinsing and drying.

CLEANING THE GLASS

Clean any glass with a soft cloth and special glass detergent.

CLEANING THE DISPLAY

Clean the display with a soft cloth and a little detergent for delicate surfaces. Avoid using considerable quantities of product since any infiltration may damage the display. Avoid also using very aggressive detergents that may damage the material the display is made of.

CLEANING THE REFRACTORY SURFACE

► Fig.45

On the refractory surface, there are normally some food residues (e.g. fat, food residues, etc.) that must be removed frequently for health and safety reasons.

Remove the coarser food residues with a natural fibre brush; then, if necessary, remove the refractory bricks of the cooking surface as shown in the figure and suck the carbonized residues accumulated under them on the bottom of the oven with an ash extraction bin.

Never use liquids to clean the refractory surface.

! **While reinserting the bricks, be careful not to pinch your fingers.**

! *Replacement refractory bricks can be obtained from the Manufacturer.*

If manual cleaning is not enough, use the PYROLYSIS function
► see page [39](#)

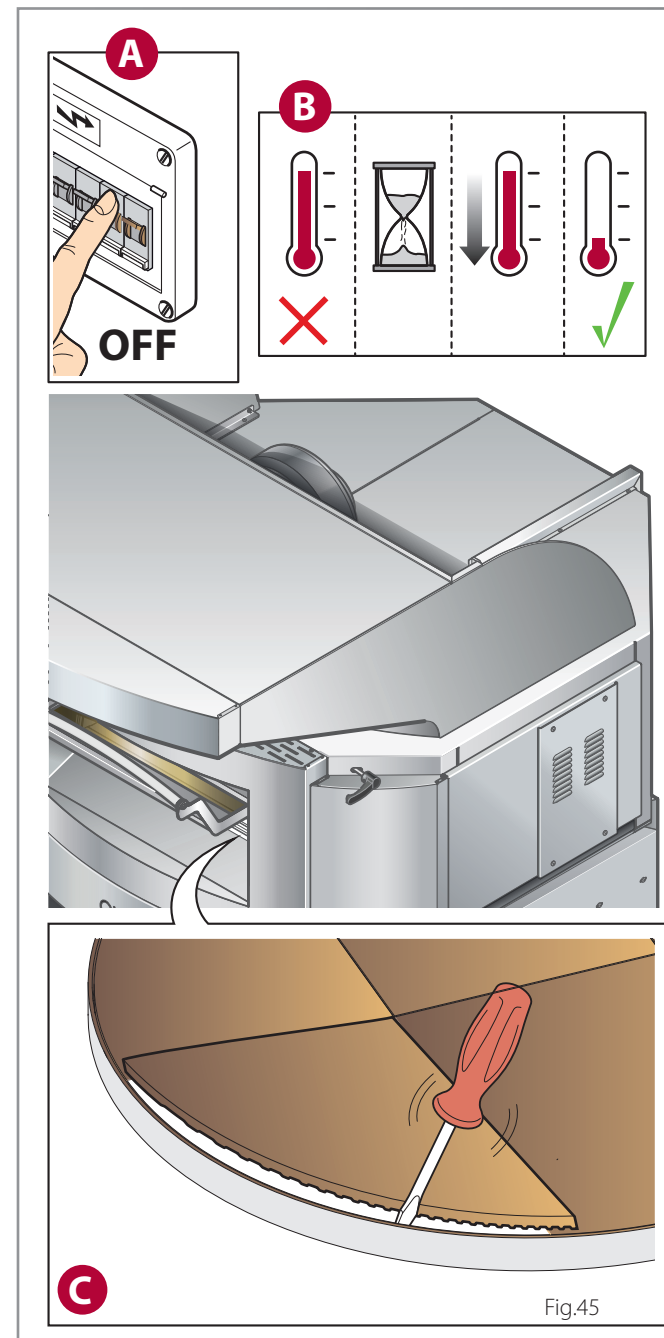



CLEANING THE CHAMBER WITH THE PYROLYSIS FUNCTION

Pyrolysis is a thermochemical crystallization process of food residues that have deposited in the cooking chamber, which takes place by bringing the oven up to 400 °C - 725 °F.

! Before starting the pyrolysis, remove the coarser food residues with a natural fibre brush.

► Fig.46

- 1 Touch the **ON/OFF**  key (if the oven is off);
- 2 touch the pyrolysis key;
- 3 confirm pressing the  key: the heating of the cooking chamber starts until the temperature of 400 °C - 752 °F is reached, when the function stops and the oven switches off automatically without you needing to do anything. To block the function in advance, press the pyrolysis key again or turn the oven off with the ON/OFF key;
- 4 in a cold oven, clean the chamber from the crystallized food residues using a natural fibre brush and then vacuum with an ash extraction bin. ► Fig.47

! When the pyrolysis function starts, the room lights are turned off to preserve them.

CHAMBER CLEANING WITH PYROLYSIS IN "WEEKLY PROGRAMMING" MODE

It is possible to clean the chamber with pyrolysis as a programmed event accessing the **programmed switch-on** menu (see page 28) and indicating the time when you want pyrolysis to be performed.



Fig.47

! Attention, if you program the start of the function:
 - at 11:59 pm on Monday, the function will start that day and at that time;
 - at 00:00 the function will always start on Monday, at midnight.

Therefore, if you want to start it at midnight on Tuesday, you must select the key relating to that day.

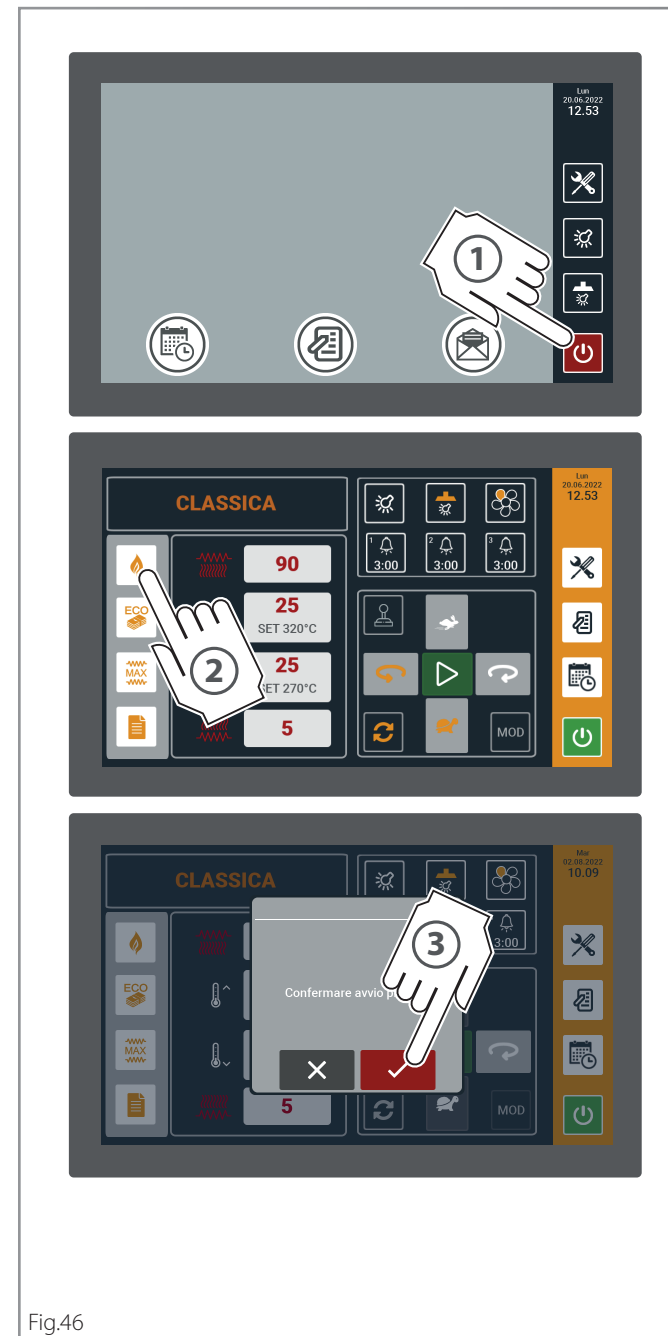





Fig.46

Replacing components

 **The user must replace only the stated components:** in case of a fault or for extraordinary maintenance, contact the Dealer, requesting service from an authorised technician.

 **For replacements, always use original spare parts to be requested from the Manufacturer:** using non-original spare parts could cause suboptimal performance of the equipment and serious damage to people and the equipment itself not recognized under warranty.

 **Before carrying out any replacement work, it is necessary to disconnect the power supply of the appliance (by acting on the system switch).**

 **Any replacement must be carried out with the oven completely cold and wearing adequate personal protection devices (e.g. gloves, etc.).**

REPLACING THE DOOR GLASS

► Fig.48

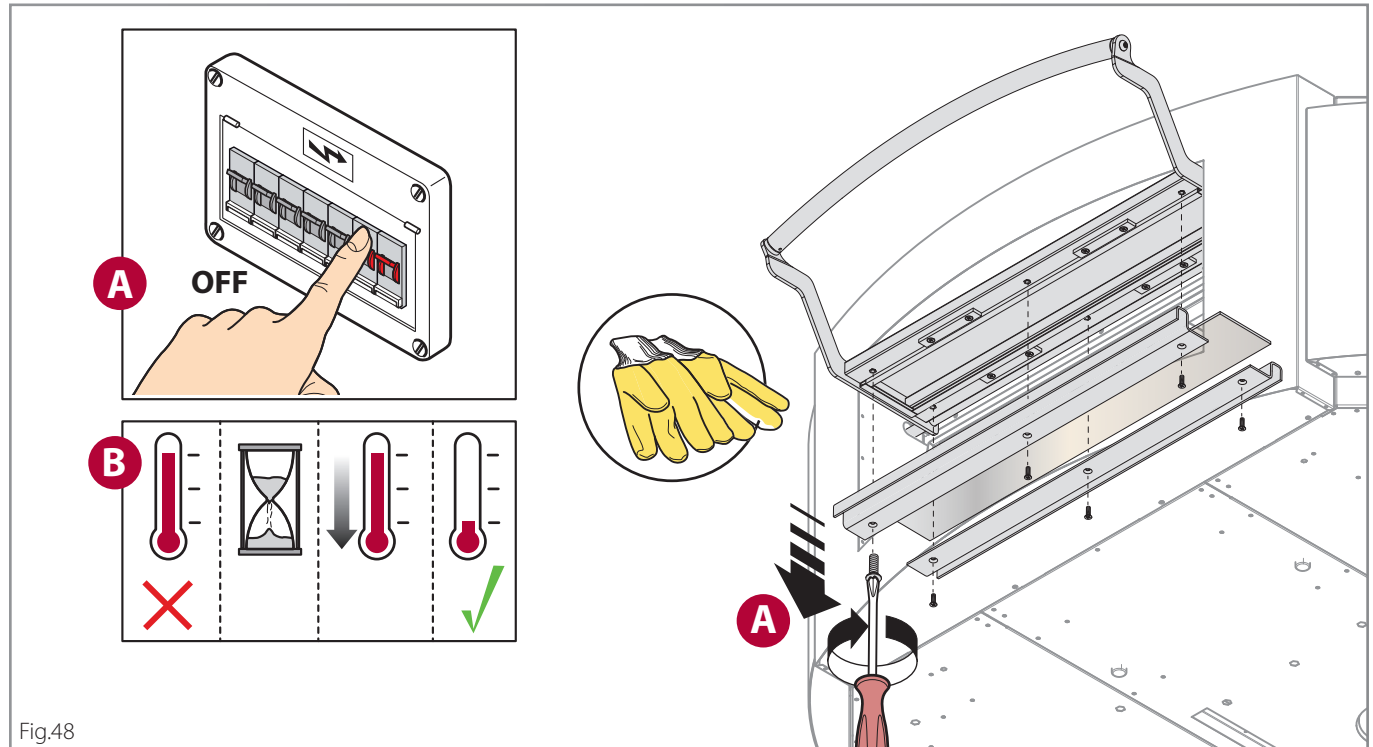

Fig.48

Oven downtime for prolonged periods

During any downtime, switch the power off. Protect the steel outside surfaces passing over them with a soft cloth slightly damp with Vaseline oil.

Leave the door ajar to guarantee correct ventilation.

Before resuming operations:

- accurately clean the equipment and accessories;
- reconnect the equipment to the power;
- inspect the equipment before using it.

Disposal at end of life

 **Before disposing of the equipment, cut or remove the power cord, with the appliance disconnected from the power supply, to avoid any unauthorized use and the risks associated with it.**

 **Block the door opening (for example with adhesive tape or clips) so that no child can accidentally be trapped inside the cooking chamber while playing.**

 Pursuant to art. 13 of Legislative Decree no. 49 of 2014 "Implementation of WEEE directive 2012/19/EU on electric and electronic waste", the barred bin symbol specifies that the product was introduced on the market after August 13, 2005 and that it must not be discarded with other waste at the end of its working life but disposed of separately. All the equipment has been made with recyclable metal materials (stainless steel, iron, aluminium, zinc plate, copper, etc.) that as a percentage make up more than 90% of the weight. Attention must be paid to the management of this product at the end of its life, reducing any negative impact on the environment and improving the efficiency of resources, applying the principles of "who pollutes pays", prevention, preparation for re-use, recycling and recovery. Please remember that illicit or incorrect product disposal is punishable by law.

Information on disposal in Italy

WEEE equipment in Italy must be delivered to:

- to Collection Centres (also named eco-islands or eco-platforms);
- the dealer where new equipment is purchased who must withdraw it free of charge ("one to one" withdrawal).

Information on disposal in European Union countries

The EU Directives on WEEE equipment has been adopted in different ways by different countries, therefore in order to dispose of this equipment correctly we suggest that you contact your local authority or your dealer in order to ask the correct method of disposal.

Disposing of ashes and food residues

 **The ash and food residues removed with cleaning must be disposed of according to the regulations in force in the country where the oven is used.**

If in doubt, we suggest contacting the local authorities to ask for the correct method of disposal.

While waiting for disposal, the ash and food residues must be stored in fireproof metal cans, resistant to high temperatures and provided with a lid that must always remain closed.

Keep the latter away from the elements and in a place inaccessible to children and animals.

Do not approach materials that can be flammable, explosive or heat-sensitive.

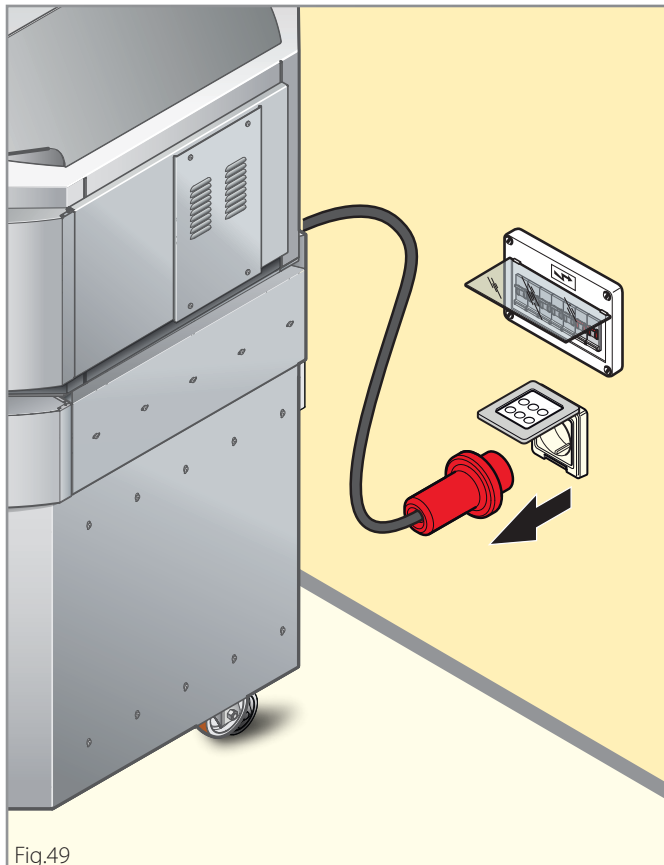

Fig.49

Warranty conditions

- 8.1 Each product sold is to be considered compliant when delivered in the quantity, quality and type indicated in the written Confirmation, please refer to the provisions of art. 1.2.
- 8.2 The Seller guarantees:
 - (a) that the Products are free from defects in materials or workmanship, and
 - (b) that (excluding the case of known defects or which should have been known by the Buyer) the Products are of marketable quality.
- 8.3 Any hidden defects in the Products must be reported in writing by the Buyer within 8 days of discovery, under penalty of forfeiture. Packaging defects - even if they have caused defects or damage to the internal product - which had to be reported at the time of delivery, are excluded pursuant to art. 5.8.
- The defect report must contain the specific indication of the defective Products, a detailed description of the type of defect that the Product has, as well as the delivery date and that of discovery.
- The warranty is excluded if the defect derives from the Purchaser's actions such as, by way of example, incorrect installation of the Product, use of the Product in a manner that does not comply with the normal method of use, failure to comply with the instructions contained in the use and installation manual, tampering with the Product. The warranty does not cover normal wear and tear of the Product due to use.
- The Seller is responsible for defects that occur within one year from the activation of the warranty as provided for in point 8.12.
- 8.4 the Seller will have the right to examine, or have a representative examine, the Product and, if this shows the existence of the defect, the Buyer will be entitled to a repair or replacement, at the Seller's sole discretion.
- It is understood that, once the defect has been reported, the Buyer must not use the Product until it is viewed by the Seller or its representative. In the event that the Seller realizes that the Product has been used after the complaint, the Buyer loses the right to obtain a replacement or repair.
- 8.5 Replacement or repair will take place under the following terms:
 - a) The Seller may repair the defective Products by going - or sending a representative - to the place where such Products are located;

- b) Alternatively, the Seller may repair the defective Product at its own factory, or other place chosen by the Seller,
- c) Alternatively, the Seller may opt for the replacement of the defective Products;
- In the event that the repair / replacement is not possible, the Seller will pay the Buyer a refund to be quantified, a refund which, however, must not exceed the price paid. Compensation for damage is excluded.
- 8.6. In case of repair of the Product at a place chosen by the Seller or in case of replacement of the defective Product, the shipment of the Product will be borne by the Buyer who must send it, at its own expense and risk, to the place stated by the Seller.
- 8.7 In no case will the Seller be liable for indirect or consequential damages and/or for loss of profits that the Buyer may suffer as a result of defects in the products such as (but not limited to) cancellation of orders by customers, penalties for delayed deliveries, penalties or refunds of any kind.
- 8.8 The Seller shall indemnify the Buyer from any liability or damage arising from defective Products, unless such liability derives from the Buyer's negligent acts or omissions or from the latter's non-fulfilment of its obligations.
- 8.9 The Seller is not liable for damage to persons and/or property that may derive from the improper use of the Products and/or from any use, processing or transformation of the Products that do not comply with their intended use and/or the instructions provided by the Seller. Save the hypothesis of gross negligence or wilful misconduct by the Seller.
- The Seller will also not be liable in the event of damage to property or injury to people or in the case of malfunction or damage or deterioration of the Product deriving from the fact that the Product has been connected to a non-compliant electrical system.
- 8.10 The Buyer will not be able to raise any claim for injury to people or damage to property other than those which are the subject of the contract, or for loss of profit, unless it results from the circumstances of the case that the Seller has committed "gross negligence".
- 8.11 "Gross negligence" does not include any and all lack of adequate care and expertise, but means an act or omission by the Seller which implies either a failure to take into consideration those serious consequences that a conscientious supplier would normally have foreseen as probably occurring, or a deliberate neglect of any consequence deriving from such act or omission.

- 8.12 The effect of the warranty referred to in this article is subject to its activation to be carried out through the website www.cuppone.com within 48 hours after the time the Product is installed.

Spare parts

- 9.1 For 10 years from delivery of the Product, the Seller undertakes, at the request of the Buyer, to assist him in identifying spare parts for product maintenance. In any case, the Seller is in no way responsible for the failure to identify such sources.

Applicable law and multi-step clause

- 11.1 Italian law, as the Seller's law, will govern sales made on the basis of these General Conditions.
- 11.2 The Parties exclude the application of the Vienna Convention.
- 11.3 The parties will submit any disputes arising from sales made on the basis of these General Conditions to the conciliation attempt provided for by the Conciliation Service of the Milan Arbitration Chamber. In the event that the attempt fails, any disputes, even of a non-contractual nature, deriving from sales made on the basis of these General Conditions, will be resolved by arbitration according to the Rules of the Milan Arbitration Chamber, by a single arbitrator/three arbitrators, appointed in compliance with this Regulation. The Arbitration Tribunal will judge according to Italian law. The seat of the arbitration will be in Milan (Italy). The language of the arbitration will be Italian.

6 SOMETHING IS NOT WORKING...

What to do in case of any malfunction

- Try and check the table on this page. If none of the proposed solutions solves the problem, continue reading the following procedure.

- Note the oven data (rating plate) and the date and number of the appliance purchase invoice.

Serial number.....

Model.....

Invoice date.....

Invoice number.....

- Read the chapter on warranty carefully.

 **WARRANTY** - page 42.

- Call an authorised Service Centre or call the dealer directly stating the appliance data. While waiting for Technical service, disconnect the appliance from the mains.

CUPPONE since 1963
 CUPPONE S.R.L.
 Via Sile, 36
 31057 Silea (TV) - ITALY
 T +39 0422 361143
 F +39 0422 360993
 info@cuppone.com - www.cuppone.com

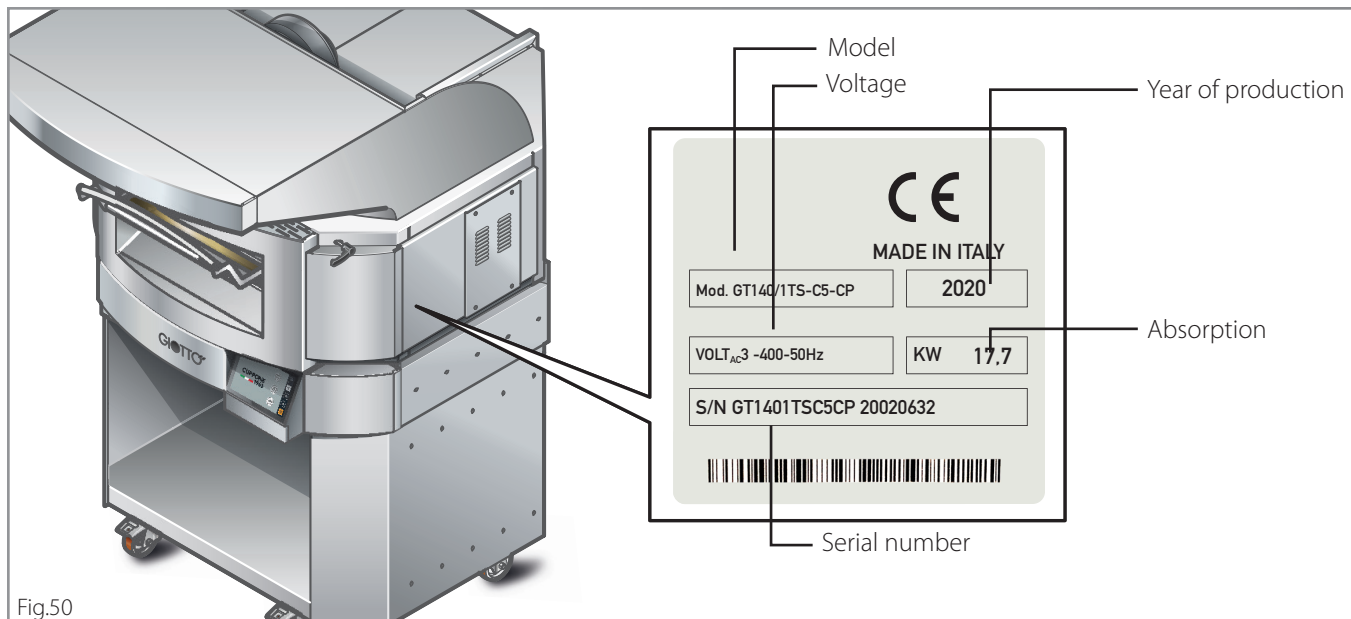

Fig.50

Problem	Solution
The oven does not turn on	<ul style="list-style-type: none"> • Make sure the oven is correctly connected to the mains (plug correctly inserted into the socket) and that the mains are working. • Make sure the main switch is ON.
The oven turns on but cooking does not start	<ul style="list-style-type: none"> • Make sure you set the cooking parameters correctly.
The oven does not cook evenly	<ul style="list-style-type: none"> • Make sure you set the cooking parameters correctly. • In case of incomplete baking cycles, change the positions of the pizzas.
The first pizzas are burnt	<ul style="list-style-type: none"> • During preheating, the BOTTOM power (percentage) has been set too high: the refractory surfaces (without pizzas) have become too hot and burnt the first pizzas.



CUPPONE since 1963

CUPPONE S.R.L.

Via Sile, 36

31057 Silea (TV) - ITALY

T +39 0422 361143

F +39 0422 360993

info@cuppone.com - www.cuppone.com

