



Instruction Manual & Documentation

Version: 25.01.2018

Citrocasa Fantastic F/D Advance
Citrocasa Fantastic F/SB Advance

Art.No.: 40.000 Version 10 ADV
Art.No.: 40.500 Version 10 ADV



Fantastic F/D Advance



Fantastic F/SB Advance

When ordering spare parts, be sure to mention machine type, article and serial number.

Industriezeile 47, 4020 Linz, Austria
Tel.: +43-732-75 01 73-0
Fax: +43-732-75 01 73-24
E-mail: office@citrocasa.com

Contents

1. IMPORTANT GENERAL INFORMATION	3
1.1. IMPORTANT INFORMATION.....	5
2. TECHNICAL SPECIFICATIONS.....	5
3. GUARANTEE.....	6
4. OPERATING INSTRUCTIONS.....	7
4.2. FIRST STEPS.....	7
4.3. CHOICE OF THE DISPLAY LANGUAGE.....	9
4.4. OPERATING THE MACHINE	10
4.4.1. Operation of Citrocasa Fantastic F/SB.....	11
4.4.2. Operation of Citrocasa Fantastic F/Digi.....	13
4.5. CLEANING INSTRUCTION.....	21
5. TROUBLESHOOTING.....	31
6. CERTIFICATE.....	33
7. MOST IMPORTANT SPARE PARTS.....	44

1. IMPORTANT GENERAL INFORMATION

This manual refers to the following model from Citrocasas:

Art.No.: 40.000

Fantastic F/D Advance Version 10 ADV

Art.No.: 40.500

Fantastic F/SB Advance Version 10 ADV

The technical data of the Citrocasas commercial Orange juicers (tension, frequency and other data) is located on the identification plate, which is both on the back page of this operating/instruction manual as well as on the equipment itself.

- For all technical questions, please refer to your official dealer or official customer service representative and mention the article and serial number of your machine which can be found on the rear side of the machine.
- Clean all areas and parts of the machine which come into contact with fruit or juice **before initial operation** as shown in the cleaning instruction.
- Before cleaning the machine, making any repairs or maintenance, it is obligatory to follow these instructions:
 1. Operate machine until no more fruits are left in the pressing area.
 2. Switch off machine according to specification of the instruction manual (depending on the machine type: by automatically stop, by pushing ON/OFF button of the machine or by releasing SB tap) and remove all remaining fruits or parts of the fruits manually of the pressing area and/or machine.
 3. Finally switch off main power of the machine and unplug machine from power supply.
- Citrocasas meets the necessary measures for a selective disposal of the devices brought on the market and provides for an environmentally friendly subsequent treatment. Please dispose of your machine in a proper way by contacting your official dealer/supplier.
- Our machines are certified and in accordance with the **CE, GS, NSF** and **TUV** safety standards.
- Before operating the machine for the first time, we ask you to please read the instruction manual carefully.
- For safety reasons, only authorized personal are allowed to make any repairs or changes on the machine. Also, no protection or safety equipment is to be changed, removed or tampered with.
- Due to the fact that no adjustments on the machine are necessary, we ask you to not open the inside of the machine at any time.
- Only authorized service technicians are permitted to make any repairs to the inside of the machine.

- In case of damage to the machine, we ask you to either contact CITROCASA directly or contact your dealer who supplied you with the machine.
- Before cleaning the machine, always unplug the machine from its power supply
- Only use original spare parts and accessories from Citrocasa.
- We give our best effort to provide you with a maximum amount of information in this document. Should you need further information, we ask you to contact us or your dealer. We will be glad to answer any questions you may have.
- In our constant efforts to better our products, we reserve the right to make any changes to this instruction manual without prior notice.
- Should you have any suggestions to improvement, questions or comments, please feel free to contact us with the contact information provided below:



Industriezeile 47, 4020 Linz, Austria
Tel.: +43-732-75 01 73-0
Fax: +43-732-75 01 73-24
E-mail: office@tmp.at

This unit can be used by children aged 8 years and above and persons with reduced physical, sensory or mental capabilities or lack of experience and knowledge when they have been given supervision or instruction concerning the safe use of the device and understand the resulting risks. Do not let children play with this device. Cleaning and user maintenance must not be carried out by children without supervision.

If the supply cord is damaged, it must be replaced by the manufacturer, its service agent or similarly qualified persons in order to avoid a hazard.

Care is needed when handling cutting blade during cleaning.

The machine does not be cleaned with a water jet.



Correct Disposal of this product:

This marking indicates that this product should not be disposed with other household wastes throughout the EU. To prevent possible harm to the environment or human health from uncontrolled waste disposal, recycle it responsibly to promote the sustainable reuse of material resources. To return your used device, please use the return and collection systems or contact the retailer where the product was purchased. They can take this product for environmental safe recycling.

1.1. IMPORTANT INFORMATION

In order to ensure a proper functioning of the machine and in order to avoid injury, we ask you to please follow the following points:

1. The fastening screws of the cross holder cannot be loose or missing.
2. Do not place any foreign objects in the machine as this may cause unnecessary damage.
3. Should machine blockage occur, it is important to disconnect the machine from its power supply, only then is the front cover to be removed in order to remove orange peels.
4. Never try to remove blockages while the machine is operating. This could lead to serious injury.
5. Due to the fact that the peel removers and the knife are important functional parts of the machine, ensure that these parts are mounted carefully and correctly.

2. TECHNICAL SPECIFICATIONS

MODEL	Fantastic F/SB Advance	Fantastic F Advance
Oranges per minute	30 pieces	30 pieces
Measurements	94,5x50x65,5	94,5x50x65,5
Net weight (in kg)	55,5 kg	55 kg
Gross weight (in kg)	59 kg	58,5 kg
Power supply	230V/50-60Hz	230V/50-60Hz
Power	0,20 kW	0,20 kW
Fuse Protection	IPx1	IPx1
Optimum fruit size	65 to 78 mm	65 to 78 mm

3. GUARANTEE

- Our quality and examination controls ensure that the machine was supplied in perfect condition.
- The guarantee covers all complaints caused by construction or material defects which influence the optimal operation of the machine.
- The guarantee does not cover any damages caused by improper usage of the machine.
- Any changes to the identification plate nullify all possibilities of any guarantee claims.
- Only qualified service personal are allowed to make any repairs or changes on the machine, should a 3rd person work on the machine, this will make any guarantee claims invalid.
- Should you need service or spare parts, always mention the correct article number or serial number of the machine.

GUARANTY DURATION: One (1) year from the time of installation.

EXCEPTIONS: LABOR COSTS, DRIVING COSTS, DELIVERY COSTS AND PARTS WHICH ARE USED BY NATURAL WEAR AND TEAR.

4. OPERATING INSTRUCTIONS

4.1. FIRST STEPS

In order to achieve an optimum operation of the machine, please follow the below-mentioned steps carefully.

- After unpacking and positioning the machine on a level surface, remove the front cover by unscrewing the 2 fastening screws shown in **Picture 1**. Lift the front cover out of its anchoring to expose the pressing system.

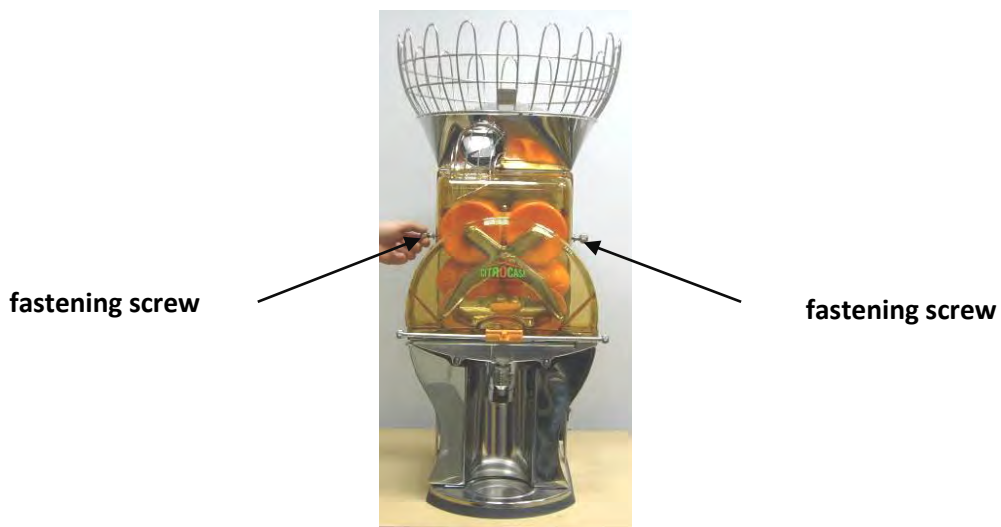

Picture 1

- Check that the supply tunnel is mounted properly and that the fixation lever is fixed (see **Picture 2**).



Picture 2

- Place the peel basket and the drip cup as shown in **Picture 3** & **Picture 4**.

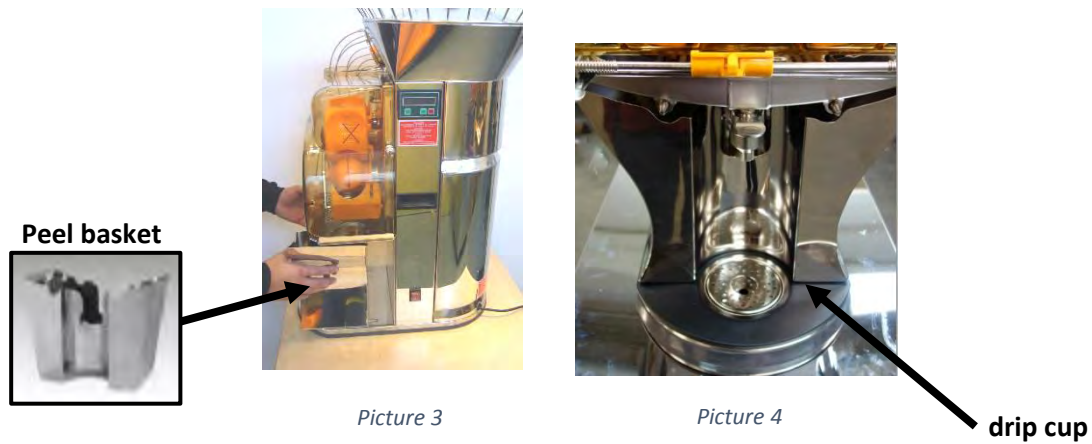

- Make sure that the MTS-System is in its proper position and that the front cover is closed (see **Picture 5**).

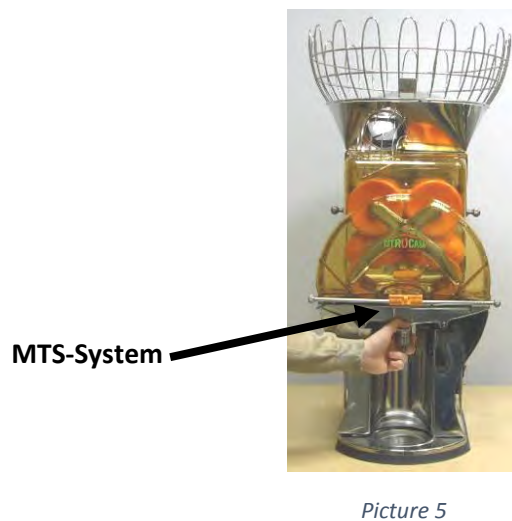

- Ensure that the voltage is identical with that shown on the identification plate.
- Plug the machine into a standardized and grounded power supply socket. Switch on the main power switch located at the side of the machine. (Red control lamp lights up, see **Picture 6**)



Picture 6

4.2. CHOICE OF THE DISPLAY LANGUAGE

It is possible to choose between 5 different display languages:

- English
- German
- Spanish
- French
- Italian

Please follow the points below, to choose your required display language:

- **Picture 7:** Switch on the main power switch located at the side of the machine. The control lamp lights up.

- **Picture 8:** No. 1: Select with the -button the menu item “Choose language”

- **Picture 8:** Nr. 2 & 3: Select your required language by pressing the ON and OFF-button / ▼ and ▲ Orange button together.

- **Picture 8:** Nr. 1: Afterwards select with the -button the required menu item. Due to this fact the display language is stored.



Picture 7

Fantastic F/SB

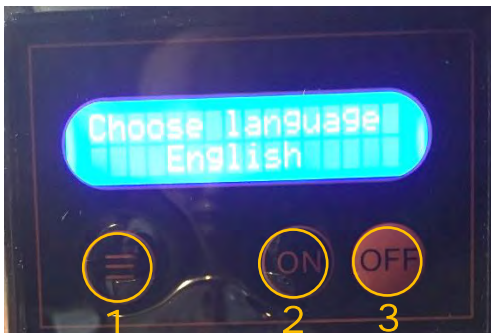

Fantastic F/D



Picture 8

4.3. OPERATING THE MACHINE

- Fill the fruit basket with oranges. Do not use fruits larger than 80mm in size. **To make sure that the machine works properly, use fruits between 65 – 78 mm in diameter.** (Picture 9)



Picture 9

4.3.1. Operation of Citrocasas Fantastic F/SB

Place a glass or another container under the juice outlet. To begin the pressing procedure, follow the instructions mentioned below:

Self-Service Mode:

- **Picture 10:** Switch on the main power switch located at the side of the machine. The red control lamp lights up.
- **Picture 11:** No. 1  button: Select the self-service mode by pressing this button. "Self service" Push "Press" is indicated on the display.
- **Picture 12:** Stop and start the machine by pressing the self-service button. (SB-tap)



Picture 10



Picture 11



Picture 12

Continuous Mode:

- **Picture 13:** Switch on the main power switch located at the side of the machine. The red control lamp lights up.
- **Picture 14:** No. 1  button: Select the continuous mode by pressing this button. „Continuous Push “ON” is indicated on the display.
- **Picture 14:** No. 2 ON button: Start pressing (continuous mode)
- **Picture 14:** No. 3 OFF button: Stop pressing (continuous mode)



Picture 13

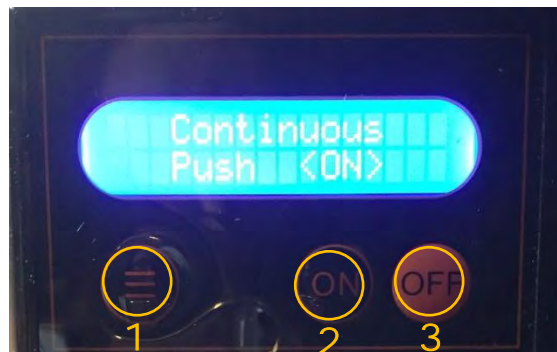

Picture 14

4.3.2. Operation of Citrocasa Fantastic F/Digi

Place a glass or another container under the juice outlet. To begin the pressing procedure, follow the instructions mentioned below:

Digi-Mode

- **Picture 15:** Switch on the main power switch located at the side of the machine. The red control lamp lights up.
- **Picture 17:** No. 1  - button: Select the Digi mode by pressing this button. push "ON" is indicated on the display.
- **Picture 17:** No. 3/4/5: Select with the ▲/▼ button the amount of oranges which should be pressed. (0-99 oranges)
- **Picture 16 & 17:** No. 6: Start the machine with the ON/OFF-button. The machine stops automatically a soon the indicated amount of oranges was pressed. The current amount of pressed oranges is shown at the display (no. 6).
- **Picture 17:** No. 2: With the +1 button one more orange will be pressed.



Picture 15



Picture 16



Picture 17

Continuous Mode:

- **Picture 18:** Switch on the main power switch located at the side of the machine. The red control lamp lights up.
- **Picture 20:** No. 1  - button: Select the continuous mode by pressing this button. „Continuous Push “ON” is indicated on the display.
- **Picture 19:** Start and stop pressing with the ON/OFF button.



Picture 19



Picture 18



Picture 20

Intelligent stop function

It is possible to adjust the machine that it stops after a certain amount of oranges → Peel bucket full! Please find the description below:

- **Picture 21:** Switch on the main power switch located at the side/rear of the machine. The control lamp lights up.
- **Picture 22:** No.1: Select the function “Empty bucket after “xx” oranges” with the -button - button
- **Picture 22:** No.2/3: Adjust the amount of oranges after the machine should stop with the ON-button/ ▲-button and OFF-button/ ▼-button.
- Start the machine in the desired mode.
- As soon as the machine has reached the adjusted amount of oranges, it stops, peeps 5 times and will be locked!
- **Picture 22:** No.3: To unlock the machine empty the peel bucket and press the OFF-button / ▼-button for 5 sec.
- Afterwards the machine can be started again.



Picture 21

Fantastic F/SB

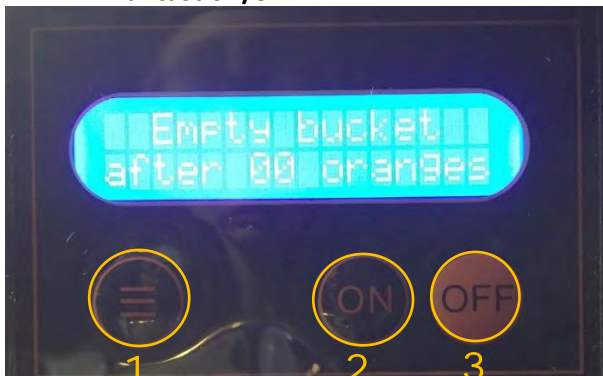

Fantastic F/D

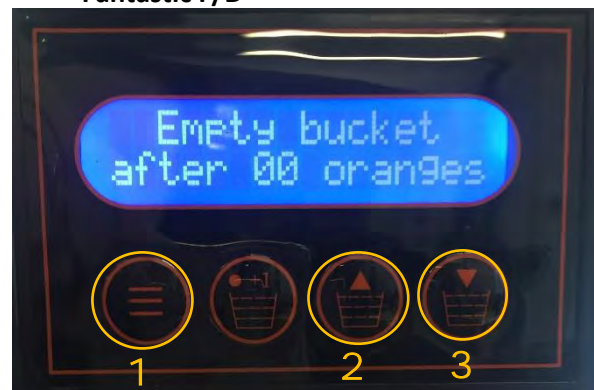

Picture 22

 **Attention**

- **Switch off intelligent stop function**
To switch off the intelligent stop function please adjust to 00 oranges!
- **Switch on intelligent stop function (adjusted orange changed from 00 – XX)**
Adjust the amount of pressed oranges – start the machine and press one orange – Machine stops automatically – Press OFF-button 5 sec – amount of oranges is saved!

Recommended adjustment regarding the intelligent stop function:

Fantastic series

Peel bucket	Recommended adjustments
Peel bucket waisted	25 oranges
Peel bucket straight	30 oranges
Cabinet/Countertop installation kit	150 oranges

Lock/Unlock function of the display

It is possible to lock the display that the adjusted mode cannot be changed unintentionally. Please find the description below:

- **Picture 23:** Switch on the main power switch located at the side/rear of the machine. The control lamp lights up.



Picture 23

Lock display

- **Picture 24:** No.2: Adjust the desired display function

- Fantastic F/SB:

Picture 24: No.1+2: Press the OFF-button + -button → Display locked

- Fantastic F/Digi:

- **Picture 24:** No.1+2: Press the -button + +1-button → Display locked



Fantastic F/SB

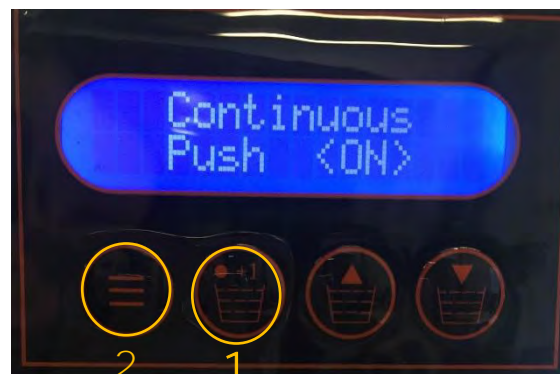

Fantastic F/D



Picture 24

The display is locked and the adjusted mode cannot be changed unintentionally. If the -button is pressed the display shows how to unlock the display - “Unlock key panel Push OFF & ” or “Unlock key panel Push  & <+1>”!!

Fantastic F/SB

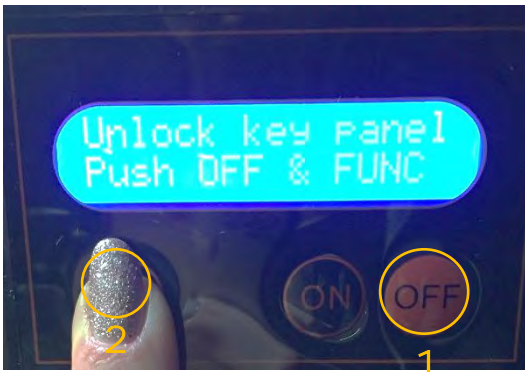

Fantastic F/D



Picture 25

Unlock display

- Fantastic F/SB:

Picture 25: No.1+2: Press the -button + OFF-button → Display unlocked

- Fantastic F/Digi:

Picture 25: No.1+2: Press the -button + +1-button → Display unlocked

Display Function – Amount of pressed oranges

- **Picture 26:** No. 1  button: Press this function button to indicate the total number of pressed fruits.

Fantastic F/SB

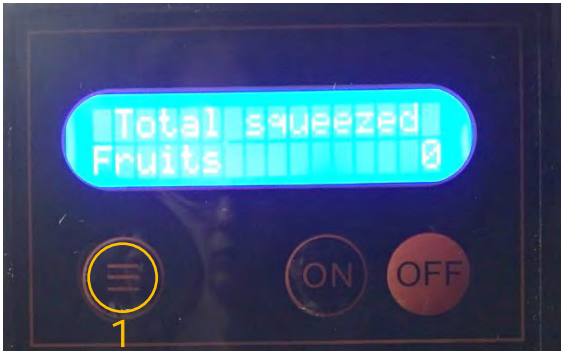

Fantastic F/D



Picture 26

Display Function – Operation time

- **Picture 27:** No. 1  button: Press this function button to indicate the total operating time.

Fantastic F/SB

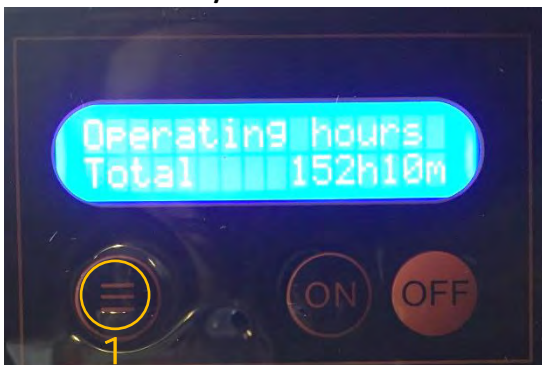

Fantastic F/D

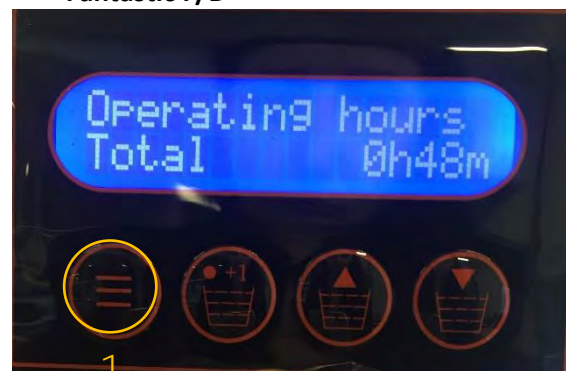

Picture 27

Factory mode (Only for technician)

The factory mode is used to adjust different parameters of the machine. This function should only be used from technician and is locked with a password.

- **Picture 28:** No.1: To skip the factory mode press the -button

Fantastic F/SB



Fantastic F/D



Picture 28

4.4. CLEANING INSTRUCTION

In order to clean the machine properly, please follow the instructions below:

The below-mentioned cleaning steps are to be completed at least twice every 24 hours.

IMPORTANT: Before cleaning the machine, ensure that the machine is disconnected from power (unplug the machine).



1. Either press the oranges remaining in the fruit basket or remove them by hand.



2. Open the fixation of the fruit basket by turning to the left and remove it



3. Remove the rotation plate.



4. Loosen the fixation screw of the orange deflector plate and remove it.



5. Remove the orange deflector plate.



6. Remove the front cover screws.



7. Remove the front cover:
Pull the lower part of the front cover slightly towards the front. Then lift the cover away from the retaining bolts.

Clean the hood with water (30 – 50°C) and a cleaning cloth to remove any juice and fruit pulp residues. Rinse thoroughly with water (30 – 50°C). Dry with disposable tissues.

CAUTION: Do not clean in a dishwasher!



8. Unscrew the cross holder screw.



9. Pull out the cross holder.



10. Separate the knife guide from the cross holder by pulling out the cross holder screw.
(3 individual parts: cross holder, knife guide, screw)

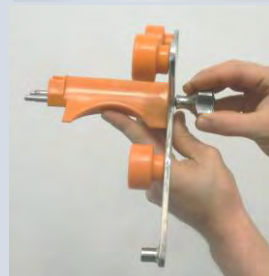

Caution: When reinstalling the knife make sure that it rests in the correct position and that the screw is properly tightened by hand.

In case of disregard, either the blade system or the upper pressing units of the machine might get damaged.





11. Remove the peel removers (right and left).



12. Remove the upper pressing units (right and left).

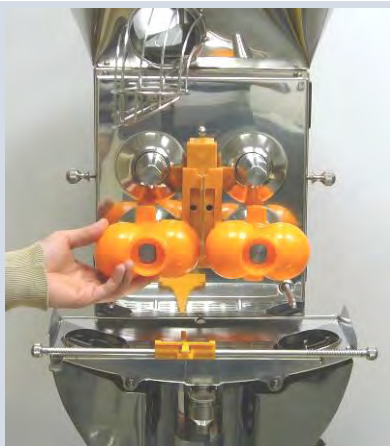

13. Remove the lower pressing units (right and left).



14. Lift the knife and pull it out.



11. Unclamp the fixation lever of the feeder and remove the supply tunnel.



15. Remove the front plate / double cover.



16. Pull out the MTS-System.

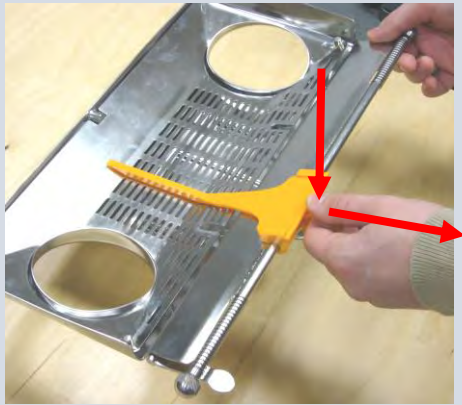

17. Remove the MTS-Pusher. Press the fixation clip and pull out the pusher.

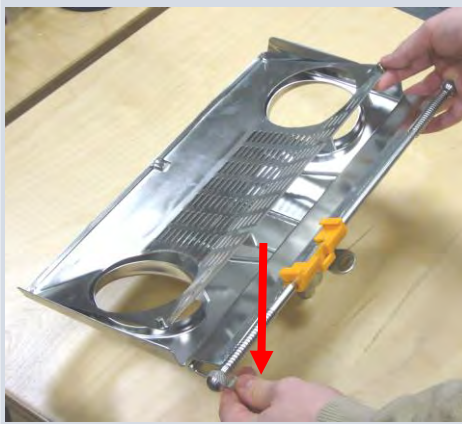

18. Press the lifting lever to Remove the fruit sieve from the fruit sieve supporter.

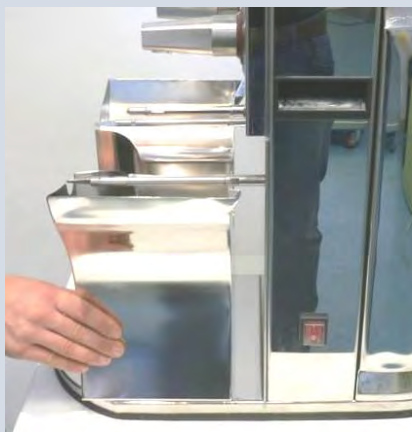

19. Remove the peel basket.



20. Remove the drip cup.



21. Remove the sieve from the cup.

Place all mentioned parts (with the exception of the acrylic front cover) in a dishwasher or clean them thoroughly by hand!



22. Clean the fruit tub.
The machine must not be cleaned by means of a water jet but with a wet cloth and clear water only. Wipe clean with a cleaning cloth and dry with a disposable tissue.



23. Clean the housing.
The machine must not be cleaned by means of a water jet but with a wet cloth and clear water only. Wipe clean with a cleaning cloth and dry with a disposable tissue.

Re-Mount all parts after cleaning in the opposite order of removal.

Ensure that all parts are correctly mounted and tightened!

We recommend to clean the machine twice within 24 hours.

PLEASE NOTE:

- **DO NOT clean the acrylic front cover in the dishwasher. Cleaning the front cover is to be done by hand with warm water and disposable drying tissues.**
- **DO NOT use any abrasive materials or decalcifying agents.**

Cleaning the Self-Service Tap

Disassembly of the self-service tap

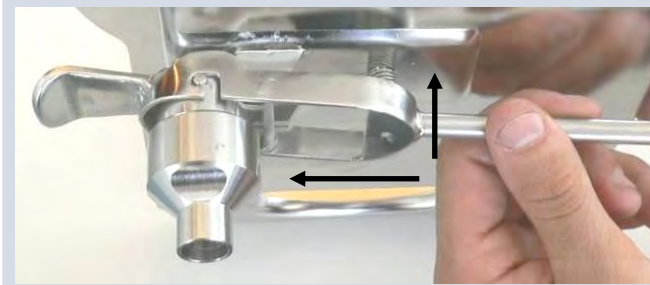

1. Press the supporter of the tap upwards, accordingly push it towards the front



2. Pull the tap bottom downwards.



3. Press the supporter upwards, accordingly push the supporter towards the back to disassemble the supporter.



4. Clean the fruit juice passage of the fruit sieve and the tap bottom properly.
5. Clean the complete tap (upper part removed from the bottom part) in a dishwasher or, alternatively, thoroughly rinse the tap in a sink.

Assembly of the self-service tap



Guide bolt

6. Re-Mount all parts after cleaning in the opposite order of removal.

Ensure that all parts are correctly mounted and tightened!

Caution:

Make sure that the guide bolt of the tap bottom faces the rear when assembling the tap.

5. TROUBLESHOOTING

PROBLEM	POSSIBLE CAUSE	SOLUTION
The machine is not working	Check if machine is plugged into power outlet	Connect to power source
	No electricity from power outlet	Check the power outlet for electricity
	Main switch off	Check if main switch on the side of machine is switched on.
	ON/OFF switch damaged	Contact your customer service representative.
	The press elements are blocked	Unplug the machine from its electricity source and remove the object which is blocking the machine in the press elements.
	Safety detectors are damaged.	Contact your customer service representative.
	Switching circuit is damaged	Contact your customer service representative.
Display shows "End position"	Magnet switch for the end position is damaged	Contact your customer service representative
Display shows "Feeder tube"	Feeder tube/Inlet tunnel mounted incorrectly	Mount the Feeder tube/Inlet basket according to the instruction manual.
Display shows "Cross holder"	Cross holder mounted incorrectly.	Mount the Cross holder according to the instruction manual.
Display shows "Fruit sieve supporter"	Fruit sieve supporter mounted incorrectly.	Mount the fruit sieve supporter according to the instruction manual.
Display shows "Front cover right"	Front cover mounted incorrectly.	Mount the front cover according to the instruction manual.
Display shows "Front cover left"	Front cover mounted incorrectly.	Mount the front cover according to the instruction manual.
Display show a error message, although all parts are mounted according to the instruction manual.	Security-Magnet is loosen or the magnet switch is damaged.	Contact your customer service representative.

PROBLEM	POSSIBLE CAUSE	SOLUTION
The machine has blocked often during the pressing process.	Power supply voltage is insufficient.	Check if the power supply coincides with that which is mentioned in the instruction manual.
	Switching circuit damaged	Contact your customer service representative.
Press elements are not synchronized	Gear wheel or axle is damaged	Contact your customer service representative.
You can hear the motor but the press elements are not turning.	Malfunction inside the machine	Contact your customer service representative.
The machine stops running periodically	Overload	Contact your customer service representative.
The machine stops often DISPLAY: OVER	Overload	Contact your customer service representative.

6. CERTIFICATE

NSF International

789 N. Dixboro Road, Ann Arbor, MI 48105 USA

RECOGNIZES

Technic Marketing Products GmbH DBA CitroCasa
Austria

AS COMPLYING WITH NSF/ANSI 8 AND ALL APPLICABLE REQUIREMENTS.
PRODUCTS APPEARING IN THE NSF OFFICIAL LISTING ARE
AUTHORIZED TO BEAR THE NSF MARK.

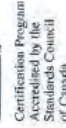

This certificate is the property of NSF International and must be returned upon request. This certificate remains valid as long as this client has products in Listing for the referenced standards. For the most current and complete Listing information, please access NSF's website (www.nsf.org).

Sarah Krol
Global Managing Director, Food Safety Product Certification

April 10, 2017
Certificate# C0034229 - 02



EG-Konformitätserklärung EC Declaration of Conformity

Hiermit erklären wir,

TMP, Technic Marketing Products GmbH
Industriezeile 47, A-4020 Linz, Austria

We herewith declare,

daß die nachfolgend bezeichnete Maschine aufgrund ihrer Konzipierung und Bauart sowie in der von uns in Verkehr gebrachten Ausführung den einschlägigen grundlegenden Sicherheits- und Gesundheitsanforderungen der EG-Richtlinien entspricht.

that the following machine complies with the appropriate basic safety and health requirements of the EC Directive based on its design and type, as brought into circulation by us.

Bei einer nicht mit uns abgestimmten Änderung der Maschine verliert diese Erklärung ihre Gültigkeit.

In case of alteration of the machine, not agreed upon by us, this declaration will lose its validity

Bezeichnung der Maschine:

Elektrische Saftpresse

Machine Description:

Maschinentyp:

8000XB, 8000SB, 7000XB, 7000SB, 6000XB, 6000XB AS,
8000SB Advance, 8000XB Advance, 8000SB-ATS Advance,
Fantastic M/AS, Fantastic M/SB, Fantastic F/Digi, Fantastic F/SB,
Fantastic M/SB Advance, Fantastic M/AS Advance, Fantastic F/SB Advance,
Fantastic F/Digi Advance

Machine Type:

Handelsmarke:

CITROCASA

Trade name

Maschinen-Nr.:

N/A

Serial Number

Einschlägige EG-Richtlinien:

EG-Maschinenrichtlinie 2006/42/EG

Applicable EC Directives:

EC Machinery Directive: 2006/42/EC

EG-Niederspannungsrichtlinie 2014/35/EG

EC Low Voltage Directive: 2014/35/EC

EG-Richtlinie über elektromagnetische Verträglichkeit (EMV) 2014/30/EG

EC Directive of Electromagnetic Compatibility 2014/30/EC

RoHS Richtlinie: 2011/65/EU

RoHS Directive: 2011/65/EU

Angewandte harmonisierte

EN 60335-1/A11:2014

Normen:

EN 60335-2-64/A1:2002

Applicable Harmonized Standards:

EN 62233:2008

EN 55014-1/A2:2011

EN 55014-2:2015

EN 61000-3-2:2014

EN 61000-3-3:2013

Dokumentationsbevollmächtigter :

*Authorized person for the
compilation of the technical
documentation :*

Herstellerunterschrift/Datum:

Authorized Signature/Date/ Place:

Angaben zum Unterzeichner:

Title of Signatory:



2017-08-11

Product Manager



America

CERTIFICATE

No. U8U 15 04 67352 027

Holder of Certificate: **TMP, Technic Marketing Products GmbH**

Industriezeile 47
4020 Linz
AUSTRIA

Production Facility(ies):

74146

Certification Mark:



Product:

Citrus juicer
Commercial Orange Juicer

Model(s):

8000SBCL, 8000SB, 8000XB, 7000SBCL,
7000SB, 7000XB, 6000XB, 6000XB AS,
8000SB Advance, 8000XB Advance,
8000SB-ATS Advance,
Fantastic M/AS, Fantastic M/SB,
Fantastic F/Digi, Fantastic F/SB,
Fantastic M/SB Advance, Fantastic M/AS Advance,
Fantastic F/SB Advance, Fantastic F/Digi Advance

Parameters:

Rated voltage:	115VAC-120VAC
Rated frequency:	60Hz
Rated input power:	370W, 260W, 280W, 300W, 160W, 160W, 180W, 180W, 200W, 260W, 280W, 180W, 180W, 180W, 180W, 140W, 160W, 180W, 180W
Protection class:	I
Degree of protection:	IPX1

Tested according to:

UL 753-2012/R-2012-10

The product was voluntarily tested according to the relevant safety requirements noted above. It can be marked with the certification mark above. The mark must not be altered in anyway. This product certification system operated by TÜV SÜD America Inc. most closely resembles system 3 as defined in ISO/IEC Guide 67. Certification is based on the TÜV SÜD "Testing and Certification Regulations". TÜV SÜD America Inc. is an OSHA recognized NRTL and a Standards Council of Canada accredited certification body.

Test report no.: 704010955002-04

Date: 2015-04-15

Page 1 of 1

William P. Meller





Product Service

CERTIFICATE

No. Z1A 16 09 67352 037

Holder of Certificate: **TMP, Technic Marketing Products GmbH**

Industriezeile 47
4020 Linz
AUSTRIA

Factory(ies):

74146

Certification Mark:



Product:

**Citrus juicer
Commercial Orange Juicer**

Model(s):

8000XB, 8000SB, 7000XB, 7000SB, 6000XB, 6000XB AS,
8000SB Advance, 8000XB Advance, 8000SB-ATS Advance,
Fantastic M/AS, Fantastic M/SB, Fantastic F/Digi,
Fantastic F/SB, Fantastic M/SB Advance,
Fantastic M/AS Advance, Fantastic F/SB Advance,
Fantastic F/Digi Advance

Parameters:

Rated voltage:	230VAC
Rated frequency:	50/60Hz
Rated input power:	280W, 280W, 150W, 150W, 150W, 150W, 260W, 280W, 280W, 200W, 200W, 200W, 200W, 200W, 200W, 200W, 200W
Protection class:	I
Degree of protection:	IPX1

Tested according to:

EN 60335-2-64:2000/A1:2002
EN 60335-1:2012/A11:2014
EN 62233:2008
AIPS GS 2014:01 PAK

The product meets the safety and health requirements of the German Product Safety Act section 20 to 22 ProdSG. The certification marks shown above can be affixed on the product. It is not permitted to alter the certification marks in any way. In addition the certificate holder must not transfer the certificate to third parties. This certificate is valid until the listed date, unless it is cancelled earlier. See also notes overleaf.

Test report no.:

704010834204-07

Valid until:

2021-09-25

Date, 2016-09-26

(Binwen Zhang)

Page 1 of 1





Product Service

Attestation of Conformity

No. M8A 16 09 67352 038

Holder of Certificate: **TMP, Technic Marketing Products GmbH**

Industriezeile 47
4020 Linz
AUSTRIA

Product: **Citrus juicer
Commercial Orange Juicer**

Model(s): **8000XB, 8000SB, 7000XB, 7000SB, 6000XB, 6000XB AS,
8000SB Advance, 8000XB Advance, 8000SB-ATS Advance,
Fantastic M/AS, Fantastic M/SB, Fantastic F/Digi,
Fantastic F/SB, Fantastic M/SB Advance,
Fantastic M/AS Advance, Fantastic F/SB Advance,
Fantastic F/Digi Advance**

Parameters:

Rated voltage:	230VAC
Rated frequency:	50/60Hz
Rated input power:	280W, 280W, 150W, 150W, 150W, 150W, 280W, 280W, 280W, 200W, 200W, 200W, 200W, 200W, 200W, 200W, 200W
Protection class:	I
Degree of protection:	IPX1

Tested according to: EN 60335-2-64:2000/A1:2002
EN 60335-1:2012/A11:2014
EN 62233:2008

This Attestation of Conformity is issued on a voluntary basis according to Council Directive 2006/42/EC relating to machinery. It confirms that the listed equipment (not Annex IV equipment) complies with the principal protection requirements of the directive. It refers only to the sample submitted to TÜV SÜD Product Service GmbH for testing and certification. See also notes overleaf.

Test report no.: 704010834204-07



Date, 2016-09-26

(Birwen Zhang)

CE After preparation of the necessary technical documentation as well as the EC declaration of conformity the required CE marking can be affixed on the product. Other relevant directives have to be observed.

Page 1 of 1



Product Service

Attestation of Conformity

No. N8A 16 09 67352 039

Holder of Certificate: **TMP, Technic Marketing Products GmbH**

Industriezeile 47
4020 Linz
AUSTRIA

Product: **Citrus juicer
Commercial Orange Juicer**

Model(s): **8000XB, 8000SB, 7000XB, 7000SB, 6000XB, 6000XB AS,
8000SB Advance, 8000XB Advance, 8000SB-ATS Advance,
Fantastic M/AS, Fantastic M/SB, Fantastic F/Digi,
Fantastic F/SB, Fantastic M/SB Advance,
Fantastic M/AS Advance, Fantastic F/SB Advance,
Fantastic F/Digi Advance**

Parameters:

Rated voltage:	230VAC
Rated frequency:	50/60Hz
Rated input power:	280W, 280W, 150W, 150W, 150W, 150W, 280W, 280W, 280W, 200W, 200W, 200W, 200W, 200W, 200W, 200W, 200W
Protection class:	I
Degree of protection:	IPX1

Tested according to:

EN 60335-2-64:2000/A1:2002
EN 60335-1:2012/A11:2014
EN 62233:2008

This Attestation of Conformity is issued on a voluntary basis according to the Low Voltage Directive 2014/35/EU relating to electrical equipment designed for use within certain voltage limits. It confirms that the listed equipment complies with the principal protection requirements of the directive and is based on the technical specifications applicable at the time of issuance. It refers only to the particular sample submitted for testing and certification. See also notes overleaf.

Test report no.: 704010834204-07



Date, 2016-09-26

(Binwen Zhang)



After preparation of the necessary technical documentation as well as the EU declaration of conformity the required CE marking can be affixed on the product. The declaration of conformity is issued under the sole responsibility of the manufacturer. Other relevant EU-directives have to be observed.

Page 1 of 1



Product Service

Attestation of Conformity

No. E8A 17 05 67352 045

Holder of Certificate: **TMP, Technic Marketing Products GmbH**

Industriezeile 47
4020 Linz
AUSTRIA

Name of Object: **Citrus juicer**
Commercial orange juicer

Model(s): 6000XB, 6000XB AS, 7000SB, 7000XB,
8000SB, 8000XB, 7000SBCL, 8000SBCL,
8000 SB Advance, 8000 XB Advance, 8000 SB-ATS Advance
Fantastic M/AS, Fantastic M/SB,
Fantastic F/Digi, Fantastic F/SB,
Fantastic M/SB Advance, Fantastic M/AS Advance
Fantastic F/SB Advance, Fantastic F/Digi Advance

Description of Object:

Rated input voltage:	AC 230V
Rated input frequency:	50/60Hz
Rated input power:	150W (6000XB, 6000XB AS, 7000SB, 7000XB) 280W(8000SB, 8000XB, 8000 SB Advance, 8000 XB Advance, 8000 SB-ATS Advance) 250W(7000SBCL) 380W(8000SBCL) 200W(Fantastic M/AS, Fantastic M/SB, Fantastic F/Digi, Fantastic F/SB, Fantastic M/SB Advance, Fantastic M/AS Advance, Fantastic F/SB Advance, Fantastic F/Digi Advance)

Protection class:
I
EN 55014-1:2006/A2:2011
EN 55014-2:2015
EN 61000-3-2:2014
EN 61000-3-3:2013

Tested according to:

This Attestation of Conformity is issued on a voluntary basis according to the Directive 2014/30/EU relating to electromagnetic compatibility. It confirms that the listed apparatus complies with all essential requirements of the directive and is based on the technical specifications applicable at the time of issuance. It refers only to the particular sample submitted for testing and certification. See also notes overleaf.

Test report no.: 708880834203-05

Date, 2017-05-16

(Hui Tong)



After preparation of the necessary technical documentation as well as the EU declaration of conformity the required CE marking can be affixed on the product. That declaration of conformity is issued under the sole responsibility of the manufacturer. Other relevant EU-directives have to be observed.



Page 1 of 1

ISEGA

Forschungs- und Untersuchungs-
Gesellschaft mbH Aschaffenburg

Dr. Ralph Derra
Öffentlich bestellter und vereidigter Sachverständiger für
Verpackungsmaterialien, Boden- und Luftanalysen;
Sachverständiger in der Wasseranalytik

7. September 2017
Dr. Dr/Be-pf

UNBEDENKLICHKEITSERKLÄRUNG
CERTIFICATE OF COMPLIANCE
CERTIFICAT DE CONFORMITE

eingetragen registered no registré	45521 U 17
für for pour	TMP - Technic Marketing Products GmbH Industriezeile 47 4020 Linz Austria
Produkt Product Produit	Orange juicer Citrocasa 6000 Citrocasa 7000 Citrocasa 8000 Citrocasa Fantastic Citrocasa 8000 Advance Citrocasa Fantastic Advance

The orange juicers manufactured by the company mentioned above are used for the preparation of orange juice.

They were examined by us according to the

Methoden zur Untersuchung von Kunststoffen, soweit sie als Bedarfsgegenstände im Sinne des Lebensmittel- und Bedarfsgegenständegesetzes verwendet werden, einschließlich der 62. Mitteilung des BfR zur Untersuchung von Hochpolymeren, Bundesgesundheitsblatt 50, 524 (2007), Stand vom April 2007,

(Methods for testing plastics as far as they are used as consumer goods as defined by the Foodstuffs and Consumer Goods Act, including the 62nd memorandum of the BfR on the examination of high polymers, Bundesgesundheitsblatt 50, 524 (2007), state of April 2007),

- 2 -

45521 U 17

for the composition as well as for the release of substances which might endanger health and to the

"Methoden zur Untersuchung von Bedarfsgegenständen, Grundregeln für die Ermittlung der Migration in Prüflebensmittel", entsprechend der Vorschrift Nr. 80.30, 1 - 3 (EG) in der Amtlichen Sammlung von Untersuchungsverfahren nach § 64 des Lebensmittel- und Futtermittelgesetzbuchs - LFGB, Stand vom April 2008,

("Methods for the examination of consumer goods, basic rules for the determination of the migration into food simulants", according to the standard no. 80.30, 1 - 3 (EC) within the Official Collection of Testing Methods according to § 64 of the Foodstuffs and Animal Feed Code - LFGB, state of April 2008),

as well as to the

Series of standards EN 1186, EN 13130 and CEN/TS 14234 "Materials and Articles in Contact with Foodstuffs – Plastics", current state,

for the migration behaviour.

The orange juicers are in compliance with the rules of the

Regulation (EC) No 1935/2004 of the European Parliament and of the Council of 27 October 2004 on materials and articles intended to come into contact with food and repealing Directives 80/590/EEC and 89/109/EEC, Official Journal of the European Union L 338/4 of 13.11.2004, modified by app. no. 5.17 of the regulation (EC) No 596/2009 of 18 June 2009, Official Journal of the European Union L 188 of 18 July 2009, article 3,

as well as of the

Lebensmittel-, Bedarfsgegenstände- und Futtermittelgesetzbuch (Lebensmittel- und Futtermittelgesetzbuch - LFGB) in der Fassung der Bekanntmachung vom 3. Juni 2013 (BGBl. I S. 1426), zuletzt geändert durch Artikel 1 des Gesetzes vom 30. Juni 2017 (BGBl. I S. 2147), §§ 30 und 31,

(Foodstuffs, Consumer Goods and Animal Feed Code (Foodstuffs and Animal Feed Code - LFGB) in the version of the notification of 3 June 2013 (BGBl. p. 1426), last amendment by article 1 of the act of 30 June 2017 (BGBl. I p. 2147), §§ 30 and 31),

and meet the demands of the

Commission Regulation (EU) No 10/2011 of 14 January 2011 on plastic materials and articles intended to come into contact with food, Official Journal of the European Union L 12/1 of 15 January 2011, last amendment by Commission Regulation (EU) No 2017/752 of 28 April 2017, Official Journal of the European Union L 113/18 of 29 April 2017,

as well as of the

Bedarfsgegenständeverordnung in der Fassung der Bekanntmachung vom 23. Dezember 1997 (BGBl. 1998 I S. 5), zuletzt geändert durch Artikel 2 Absatz 1 des Gesetzes vom 15. Februar 2016 (BGBl. I S. 198),

45521 U 17

(Decree on Consumer Goods in the version of the communication of 23 December 1997 (BGBl. 1998 I p. 5), last modification by Article 2 section 1 of the Law of 15 February 2016 (BGBl. I p. 198)),

with regard to the migration behaviour.

Thus, the orange juicers of the series Citrocasa 6000, Citrocasa 7000, Citrocasa 8000, Citrocasa Fantastic, Citrocasa 8000 Advance and Citrocasa Fantastic Advance according to the sample device submitted may be used safely for the intended purpose.

This certificate of compliance represents the latest technical standard and is based on the certificate of compliance no. 35981 U 13 of 25 July 2013 in connection with a new partial examination of the products.

This certificate of compliance has a validity of 2 years and consists of 4 pages.

Certification decision



(Behrendt)
Officially certified
and authorized food
chemist

The translation of the above stamps is given on page 4.
La traduction des estampilles est donnée en page 4.

- 4 -



Staatlich anerkannter Sachverständiger zur Untersuchung der Gegenproben von Verpackungsmitteln aus Papier, Pappe, Kunststoffen, Glas, Weißblech und sonstigen Metallverpackungen auf ihre lebensmittelrechtliche Unbedenklichkeit

Dr. Ralph Derra

Authorized expert for the analyses of packaging materials, attested by the Aschaffenburg Chamber of Industry and Commerce.

Expert autorisé pour l'analyse des matériaux d'emballage, assermenté par la Chambre d'Industrie et de Commerce d'Aschaffenburg.

State registered expert for the analysis of contrasting samples of packaging materials of paper, board, plastics, glass, tin plate and other metallic packaging materials as to their suitability for use with foodstuffs.

Expert public pour l'étude du contrôle des contre-échantillons d'emballages de papier, cartons, plastiques, verre, fer-blanc et d'autres emballages métalliques concernant leur conformité alimentaire.



Dr. Ralph Derra

Authorized expert for the analyses of soil and air, attested by the Aschaffenburg Chamber of Industry and Commerce.

Expert autorisé pour l'analyse du sol et de l'air, assermenté par la Chambre d'Industrie et de Commerce d'Aschaffenburg.

Die Rücklagen des untersuchten Materials werden bei der Gutachterstelle verwahrt.
Dieses Dokument ist eine Übersetzung einer deutschen Originalversion. In Streitfällen ist das Originaldokument die rechtlich bindende Version.
A file sample of the tested material is kept at the expert's office.
This document is a translation of an original in German. In case of dispute, the original document should be taken as authoritative.

7. MOST IMPORTANT SPARE PARTS



 <p>500.104.100</p>	<p>Peel remover left</p> <p>Art. No.: 500.104.100</p>
 <p>500.105.100 12</p>	<p>Peel remover right</p> <p>Art. No.: 500.105.100</p>
 <p>500108032</p>	<p>Knife SCS Up&Down</p> <p>Art. No.: 500.108.032</p>
 <p>500109002</p>	<p>Knife guide</p> <p>Art. No.: 500.109.002</p>



 <p>500.111.022</p>	<p>Plastic knob of the cross holder</p> <p>Art. No.: 500.111.022</p>
 <p>500211003</p>	<p>Cross holder</p> <p>Art. No.: 500.211.003</p>
	<p>Bolt with magnet of the cross holder</p> <p>Art. No.: 500.212.023</p>
 <p>500213023</p>	<p>Screw of the cross holder</p> <p>Art. No.: 500.213.023</p>

 <p>500223033 500223023 500113020</p> <p>500223040</p>	<p>Double cover / Double plate complete</p> <p>Art. No.: 500.223.040</p>
 <p>500225003</p>	<p>Front cover screw</p> <p>Art. No.: 500.225.003</p>
	<p>Electronic box / Main electronics</p> <p>Art. No.: 500.280.000-V2</p>
 <p>500113002 600651007 600665007 500112002</p> <p>500113020</p>	<p>Knife holder and guide on the front plate complete</p> <p>Art. No.: 500.113.020</p>

 <p>60065300</p>	<p>Magnet and magnet cover of the front cover</p> <p>Art. No. 600.653.000</p>
 <p>500.110.010</p>	<p>Front cover Fantastic</p> <p>Art. No.: 500.110.010</p>
 <p>800160022</p>	<p>Upper pressing unit</p> <p>Art. No.: 800.160.022</p>
 <p>500106012</p>	<p>Lower pressing unit</p> <p>Art. No. 500.106.012</p>

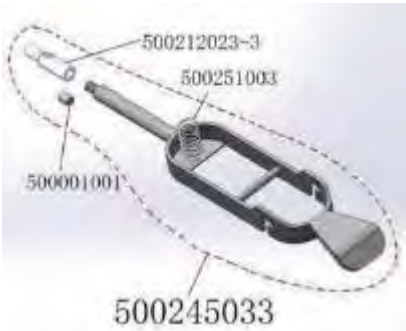
 <p>500288050</p>	<p>MTS-System Fantastic SB</p> <p>Art. No.: 500.288.050</p>
 <p>500289030</p>	<p>MTS-System Fantastic AS + Digi</p> <p>Art. No.: 500.289.030</p>
 <p>500286003</p>	<p>Pusher MTS-System Fantastic</p> <p>Art. Nr.: 500.286.003</p>
 <p>800131002</p>	<p>Pusher support MTS-System Fantastic</p> <p>Art. Nr.: 800.131.002</p>

 <p>500299003</p>	<p>Schraube MTS-System</p> <p>Art. Nr.: 500.299.003</p>
 <p>500287003</p>	<p>Spring MTS-System (Pusher)</p> <p>Art. No.: 500.287.003</p>
 <p>500268050</p>	<p>Lower part SB-Tap</p> <p>Art. Nr.: 500268050</p>
 <p>500245033</p>	<p>SB-Tap lever</p> <p>Art. Nr.: 500245033</p>

 <p>500216073</p>	<p>Peel basket waisted</p> <p>Art. No.:500.216.073</p>
 <p>500120052</p>	<p>Ground plate inlet</p> <p>Art. No.:500.120.052</p>