



## PRODUCT LIST 2017

1. PROFESSIONAL KITCHEN WORKTABLES
2. OTHER TABLES AND STANDS
3. DISHWASHING EQUIPMENT
4. SHELVES AND CUPBOARDS
- 5. TROLLEYS**
6. EXHAUST HOODS
7. BAR EQUIPMENT
8. SERVING LINE EQUIPMENT
9. COOLING COUNTERS AND HEATED EQUIPMENT
10. MODULAR TABLES

**YOUR RELIABLE PARTNER**

*Novameta is the largest and most advanced manufacturer of stainless steel commercial kitchen equipment in Baltic and Scandinavian countries. Extensive 16-year experience, attention to details along with an innovative mindset are the key factors which have enabled Novameta to establish trust in 18 markets throughout Europe.*

*A wide range of hot, cold and neutral standard equipment, precisely engineered and crafted non-standard products combined with a short, typically 2-4 week lead time is what makes us stand out of the crowd. What is more, our experienced team is all set to provide professional support and technical advice, enabling our clients to turn their ideas to tailor made turnkey solutions.*

*All of our products are marketed through a professional network of distributors throughout Europe. We are proud to provide an all-round assistance to our dealers, helping them to excel in the things they do best - planning, taking care of supply, installation and service to fulfil the needs of catering, bakery and retail industries.*

*Our main objectives are to maintain solid positions in Europe through sustaining partnership relationships with our clients, whilst at the same time expanding into new markets worldwide. Experienced and ambitious sales team, application of up-to-date 3D CAD software in our in-house design department, employment of latest production technologies and LEAN quality management based on ISO 9001:2000 standard, have determined the rapid expansion of our sales markets and therefore the consequent quick growth of the company.*

*Currently, over 165 employees work in the enterprise and the production area covers 5000 m<sup>2</sup>. Novameta manufactures over 180 different items every day, more than 1000 projects yearly!*



**Novameta**  
 Draugystės g. 15D, LT-51227 Kaunas, Lithuania  
 + 370 37 30 23 30  
 novameta@novameta.lt  
 www.novameta.lt

**Novameta UK**  
 1210 Parkview, Arfington Business Park, Theale, Reading, Berkshire RG7 4TY, UK  
 +44 118 965 4098  
 +44 791 874 0027  
 sales@novameta.co.uk  
 www.novameta.co.uk

© 2017 Novameta. All rights reserved.  
 Novameta respects the intellectual property rights of others and expects its clients and the users of its services to do the same.  
 All information in this publication is property of Novameta and you do not have right to disclose it to any third party without permission.  
 Technical specifications and prices are subject to change.

**CONTENTS**

	<b>VTGN/VTGD</b>	TROLLEY FOR GASTRONORM CONTAINERS.....	5.4
	<b>VTGN/VTGD</b>	DOUBLE TROLLEY FOR GASTRONORM CONTAINERS.....	5.6
	<b>VTGZ</b>	Z-INSERT TROLLEY FOR GASTRONORM CONTAINERS.....	5.8
	<b>VTT</b>	TROLLEY FOR BAKERY TRAYS.....	5.10
	<b>VTB</b>	TROLLEY FOR DISHWASHER BASKETS.....	5.12
	<b>VTBL7</b>	TROLLEY FOR DISHWASHER BASKETS WITH PLATE SHELF.....	5.14
	<b>VTBL4</b>	TROLLEY FOR DISHWASHER BASKETS WITH 2 PLATE SHELVES.....	5.14
	<b>VTTM1</b>	TROLLEY FOR TRAYS.....	5.16
	<b>VTTM2</b>	DOUBLE TROLLEY FOR TRAYS.....	5.16
	<b>VTR</b>	SERVICE TROLLEY ASSEMBLED.....	5.18
	<b>VTS2</b>	SERVICE TROLLEY WELDED WITH 2 SHELVES.....	5.20
	<b>VTS3</b>	SERVICE TROLLEY WELDED WITH 3 SHELVES.....	5.22
	<b>VTS4</b>	SERVICE TROLLEY WELDED WITH 4 SHELVES.....	5.24
	<b>VTL2</b>	TROLLEY FOR PLATES.....	5.26
	<b>VTP1</b>	TRANSPORTATION TROLLEY - PLATFORM.....	5.26
	<b>VTSM1</b>	TROLLEY FOR PLASTIC BAGS.....	5.28
	<b>VTI1</b>	TROLLEY FOR CUTLERY WITH VALVE.....	5.28
	<b>VTBD1</b>	DISPENSER TROLLEY FOR DISHWASHER BASKETS.....	5.30
	<b>VTTD1</b>	DISPENSER TROLLEY FOR TRAYS.....	5.30
	<b>VTLD2</b>	NEUTRAL DISPENSER TROLLEY FOR PLATES.....	5.32
	<b>VTLW2</b>	HEATED DISPENSER TROLLEY FOR PLATES.....	5.32
		TERMS AND CONDITIONS.....	5.36
		REFERENCES AND EXAMPLES OF CUSTOMISED EQUIPMENT.....	5.38

## TROLLEY FOR GASTRONORM CONTAINERS

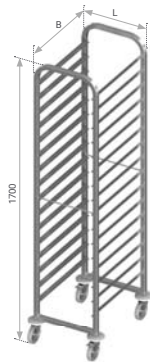

*f* Different dimensions and configurations are available on request. Examples on page 5.30.

Length L, mm	Width B, mm		Amount of guides	Distance between guides, mm	Dimensions of container, mm
	530	Model			
380	VTGN12-38/53/170	12	117	1/1 GN 325 x 530	
380	VTGN14-38/53/170	14	100	1/1 GN 325 x 530	
380	VTGN16-38/53/170	16	88	1/1 GN 325 x 530	
380	VTGN18-38/53/170	18	78	1/1 GN 325 x 530	
380	VTGN20-38/53/170	20	70	1/1 GN 325 x 530	

Length L, mm	Width B, mm		Amount of guides	Distance between guides, mm	Dimensions of container, mm
	650	Model			
585	VTGD12-58/65/170	12	117	2/1 GN 530 x 650	
585	VTGD14-58/65/170	14	100	2/1 GN 530 x 650	
585	VTGD16-58/65/170	16	88	2/1 GN 530 x 650	
585	VTGD18-58/65/170	18	78	2/1 GN 530 x 650	
585	VTGD20-58/65/170	20	70	2/1 GN 530 x 650	

### STANDARD FEATURES

#### HYGIENIC TYPE OF WELDING



Set of galvanized wheels Ø100 mm (4 pcs), 2 pcs with brakes, plastic protecting bumpers

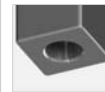

Heavy duty welded steel hub for mounting the wheels

### OPTIONAL FEATURES



#### Swing lock on one side

Code: A-VFU1



#### Swing lock on both sides

Code: A-VFU2



#### Set of galvanized wheels Ø125 mm (4 pcs), 2 pcs with brakes

Code: K-RAX125-157NCG



#### Set of stainless steel wheels Ø125mm (4 pcs), 2 pcs with brakes

Code: K-RAX125-157NNG

## DOUBLE TROLLEY FOR GASTRONORM CONTAINERS

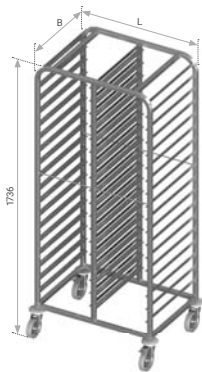

*i* Different dimensions and configurations are available on request. Examples on page 5.30.

Length L, mm	Width B, mm		Amount of guides	Distance between guides, mm	Dimensions of container, mm
	530	Model			
735	VTGN24-74/53/174	24	117	1/1 GN 325 x 530	
735	VTGN28-74/53/174	28	100	1/1 GN 325 x 530	
735	VTGN32-74/53/174	32	88	1/1 GN 325 x 530	
735	VTGN36-74/53/174	36	78	1/1 GN 325 x 530	

Length L, mm	Width B, mm		Amount of guides	Distance between guides, mm	Dimensions of container, mm
	650	Model			
1145	VTGD24-115/65/174	24	117	2/1 GN 530 x 650	
1145	VTGD28-115/65/174	28	100	2/1 GN 530 x 650	
1145	VTGD32-115/65/174	32	88	2/1 GN 530 x 650	
1145	VTGD36-115/65/174	36	78	2/1 GN 530 x 650	

### STANDARD FEATURES

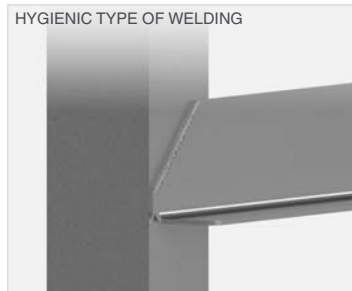

HYGIENIC TYPE OF WELDING



Set of galvanized wheels Ø125 mm (4 pcs), 2 pcs with brakes, plastic protecting bumpers

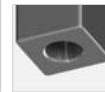

Heavy duty welded steel hub for mounting the wheels

### OPTIONAL FEATURES



Swing lock on one side

Code: A-VFU1



Swing lock on both sides

Code: A-VFU2



Set of stainless steel wheels Ø125mm (4 pcs), 2 pcs with brakes

Code: K-RAX125-157NNG

## Z-INSERT TROLLEY FOR GASTRONORM CONTAINERS

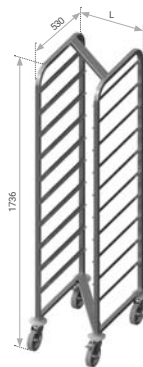

*f* Different dimensions and configurations are available on request. Examples on page 5.30.

Length L, mm	Width B, mm		Amount of guides	Distance between guides, mm	Dimensions of container, mm
	530	Model			
380	VTG210-36/53/174	10	140	1/1 GN 325 x 530	
380	VTG212-36/53/174	12	117	1/1 GN 325 x 530	
380	VTG214-36/53/174	14	100	1/1 GN 325 x 530	
380	VTG216-36/53/174	16	88	1/1 GN 325 x 530	
380	VTG218-36/53/174	18	78	1/1 GN 325 x 530	
380	VTG220-36/53/174	20	70	1/1 GN 325 x 530	

### STANDARD FEATURES

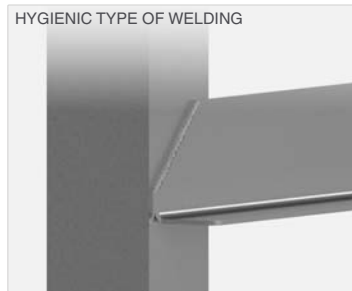

Set of galvanized wheels Ø125 mm (4 pcs), 2 pcs with brakes, plastic protecting bumpers

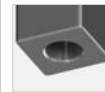

Heavy duty welded steel hub for mounting the wheels

### OPTIONAL FEATURES



Swing lock on one side

Code: A-VFU1



Swing lock on both sides

Code: A-VFU2



Set of stainless steel wheels Ø125mm (4 pcs), 2 pcs with brakes

Code: K-RAX125-157NNG

Trolleys may be inserted together, saving up to 80% of space.

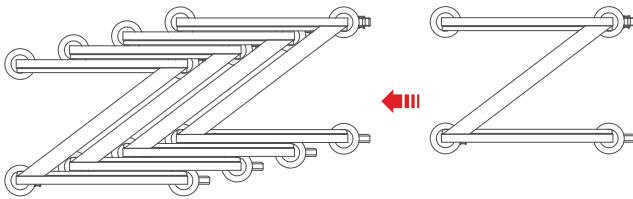

## TROLLEY FOR BAKERY TRAYS

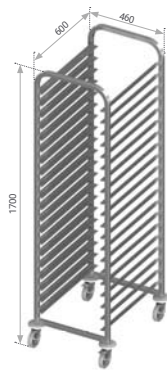

*f* Different dimensions and configurations are available on request. Examples on page 5.30.

Length L, mm	Width B, mm		Amount of guides	Distance between guides, mm	Dimensions of tray, mm
	600	Model			
460		VTT10-46/60/170	10	148	Baking tray 600 x 400
460		VTT12-46/60/170	12	123	Baking tray 600 x 400
460		VTT14-46/60/170	14	106	Baking tray 600 x 400
460		VTT16-46/60/170	16	92	Baking tray 600 x 400
460		VTT18-46/60/170	18	80	Baking tray 600 x 400
460		VTT20-46/60/170	20	72	Baking tray 600 x 400

### STANDARD FEATURES

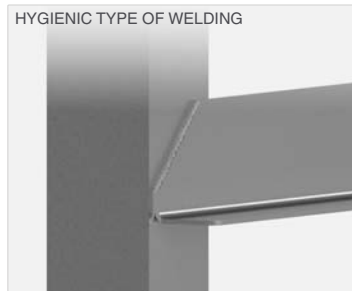

Set of galvanized wheels Ø100 mm (4 pcs), 2 pcs with brakes, plastic protecting bumpers

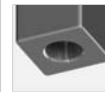

Heavy duty welded steel hub for mounting the wheels

### OPTIONAL FEATURES



Swing lock on one side

Code: A-VF-U1



Swing lock on both sides

Code: A-VF-U2



Set of galvanized wheels Ø125 mm (4 pcs), 2 pcs with brakes

Code: K-RAX125-157NCG



Set of stainless steel wheels Ø125mm (4 pcs), 2 pcs with brakes

Code: K-RAX125-157NNG

## TROLLEY FOR DISHWASHER BASKETS

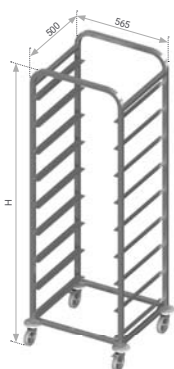

*f* Different dimensions and configurations are available on request. Examples on page 5.30.

Length L, mm	Width B, mm		Amount of guides	Distance between guides, mm	Dimensions of basket, mm
	500	Model			
565		VTB3-57/50/78	3	185	500 x 500
565		VTB4-57/50/78	4	130	500 x 500
565		VTB6-57/50/170	6	250	500 x 500
565		VTB7-57/50/170	7	210	500 x 500
565		VTB8-57/50/170	8	185	500 x 500
565		VTB9-57/50/170	9	165	500 x 500
565		VTB10-57/50/170	10	145	500 x 500

### STANDARD FEATURES



Set of galvanized wheels Ø100 mm (4 pcs), 2 pcs with brakes, plastic protecting bumpers

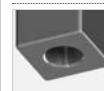

Heavy duty welded steel hub for mounting the wheels

### OPTIONAL FEATURES



Swing lock on one side

Code: A-VF-U1



Swing lock on both sides

Code: A-VF-U2



Set of galvanized wheels Ø125 mm (4 pcs), 2 pcs with brakes

Code: K-RAX125-157NCG



Set of stainless steel wheels Ø125mm (4 pcs), 2 pcs with brakes

Code: K-RAX125-157NNG

## TROLLEY FOR DISHWASHER BASKETS WITH PLATE SHELF

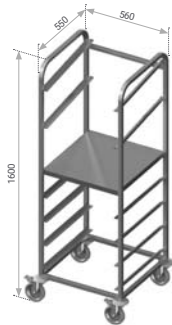

*f* Different dimensions and configurations are available on request. Examples on page 5.30.

Length L, mm	Width B, mm		Dimensions of basket, mm
	550	Model	
560		VTBL7-56/55/160	500 x 500

### STANDARD FEATURES



Set of galvanized wheels Ø125 mm (4 pcs), 2 pcs with brakes, plastic protecting bumpers

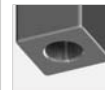

Heavy duty welded steel hub for mounting the wheels

### OPTIONAL FEATURES



Set of stainless steel wheels Ø125mm (4 pcs), 2 pcs with brakes

Code: K-RAX125-157NNG

## TROLLEY FOR DISHWASHER BASKETS WITH 2 PLATE SHELVES



*f* Different dimensions and configurations are available on request. Examples on page 5.30.

Length L, mm	Width B, mm		Dimensions of basket, mm
	550	Model	
565		VTBL4-57/55/109	500 x 500

### STANDARD FEATURES



Set of galvanized wheels Ø125 mm (4 pcs), 2 pcs with brakes, plastic protecting bumpers

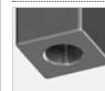

Heavy duty welded steel hub for mounting the wheels

### OPTIONAL FEATURES



Set of stainless steel wheels Ø125mm (4 pcs), 2 pcs with brakes

Code: K-RAX125-157NNG



## TROLLEY FOR TRAYS



NEW

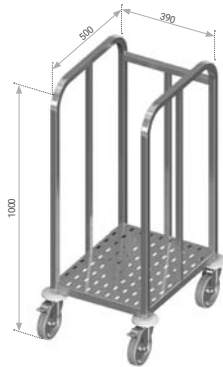

*f* Different dimensions and configurations are available on request. Examples on page 5.30.

Length L, mm	Width B, mm		Dimensions of tray, mm	Amount of trays
	500	Model		
390		VTTM1-39/50/100	430 x 330	135

DESIGNED FOR TRAYS  
(430 x 330 mm)



### STANDARD FEATURES

Set of galvanized wheels Ø125 mm (4 pcs),  
2 pcs with brakes, plastic protecting bumpers



Heavy duty welded steel hub for mounting the wheels



Perforated shelf

### OPTIONAL FEATURES



Set of stainless steel wheels Ø125mm (4 pcs),  
2 pcs with brakes

Code: K-RAX125-157NNG

## DOUBLE TROLLEY FOR TRAYS

NEW

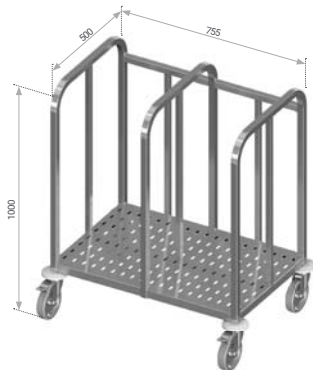

*f* Different dimensions and configurations are available on request. Examples on page 5.30.

Length L, mm	Width B, mm		Dimensions of tray, mm	Amount of trays
	500	Model		
755		VTTM2-76/50/100	430 x 330	2 x 135

DESIGNED FOR TRAYS  
(430 x 330 mm)



### STANDARD FEATURES

Set of galvanized wheels Ø125 mm (4 pcs),  
2 pcs with brakes, plastic protecting bumpers



Heavy duty welded steel hub for mounting the wheels



Perforated shelf

### OPTIONAL FEATURES



Set of stainless steel wheels Ø125mm (4 pcs),  
2 pcs with brakes

Code: K-RAX125-157NNG

SERVICE TROLLEY ASSEMBLED

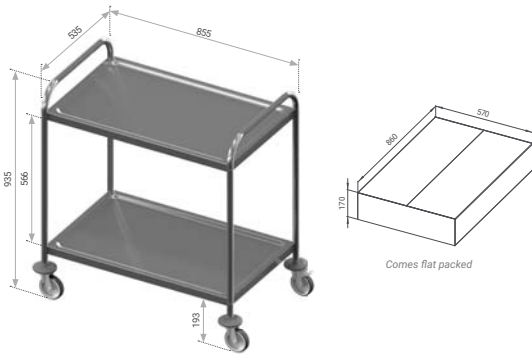

STANDARD FEATURES

EASY TO ASSEMBLE



Set of galvanized wheels Ø100 mm (4 pcs), 2 pcs with brakes, plastic protecting bumpers

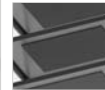

Shelves with noise dampening pads



Max loading 50 kg/shelf (uniform layout)

Length L, mm	Width B, mm	Shelves
	Model	
855	VTR2-86/54/94	2
855	VTR3-86/54/94	3

## SERVICE TROLLEY WELDED WITH 2 SHELVES

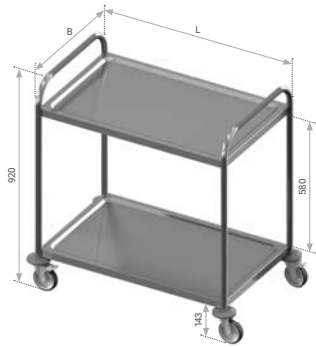

### STANDARD FEATURES

#### HEAVY DUTY WELDED SHELVES



Set of galvanized wheels Ø100 mm (4 pcs), 2 pcs with brakes, plastic protecting bumpers

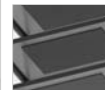

Shelves with noise dampening pads



Heavy duty welded shelves  
Max loading 50 kg/shelf (uniform layout)

*Different dimensions and configurations are available on request.*

Length L, mm	Width B, mm				
	500	550	600	650	700
	Model	Model	Model	Model	Model
700	VTS2-70/50/92	VTS2-70/55/92	VTS2-70/60/92	VTS2-70/65/92	VTS2-70/70/92
750	VTS2-75/50/92	VTS2-75/55/92	VTS2-75/60/92	VTS2-75/65/92	VTS2-75/70/92
800	VTS2-80/50/92	VTS2-80/55/92	VTS2-80/60/92	VTS2-80/65/92	VTS2-80/70/92
850	VTS2-85/50/92	VTS2-85/55/92	VTS2-85/60/92	VTS2-85/65/92	VTS2-85/70/92
900	VTS2-90/50/92	VTS2-90/55/92	VTS2-90/60/92	VTS2-90/65/92	VTS2-90/70/92
950	VTS2-95/50/92	VTS2-95/55/92	VTS2-95/60/92	VTS2-95/65/92	VTS2-95/70/92
1000	VTS2-100/50/92	VTS2-100/55/92	VTS2-100/60/92	VTS2-100/65/92	VTS2-100/70/92
1050	VTS2-105/50/92	VTS2-105/55/92	VTS2-105/60/92	VTS2-105/65/92	VTS2-105/70/92
1100	VTS2-110/50/92	VTS2-110/55/92	VTS2-110/60/92	VTS2-110/65/92	VTS2-110/70/92
1150	VTS2-115/50/92	VTS2-115/55/92	VTS2-115/60/92	VTS2-115/65/92	VTS2-115/70/92
1200	VTS2-120/50/92	VTS2-120/55/92	VTS2-120/60/92	VTS2-120/65/92	VTS2-120/70/92
1250	VTS2-125/50/92	VTS2-125/55/92	VTS2-125/60/92	VTS2-125/65/92	VTS2-125/70/92
1300	VTS2-130/50/92	VTS2-130/55/92	VTS2-130/60/92	VTS2-130/65/92	VTS2-130/70/92

Length L, mm	Width B, mm	
	530	Model
855	VTS2-86/53/92	

### OPTIONAL FEATURES



**Set of galvanized wheels Ø125 mm (4 pcs), 2 pcs with brakes**  
Code: K-RAX125-157NCG  
Price: 19 €



**Set of stainless steel wheels Ø125mm (4 pcs), 2 pcs with brakes**  
Code: K-RAX125-157NNG  
Price: 103 €

## SERVICE TROLLEY WELDED WITH 3 SHELVES

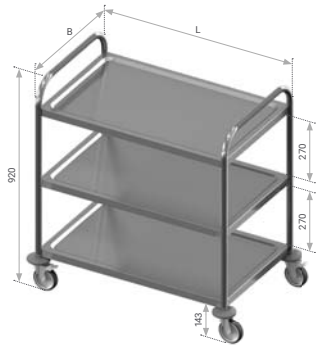

### STANDARD FEATURES

#### HEAVY DUTY WELDED SHELVES



Set of galvanized wheels Ø100 mm (4 pcs), 2 pcs with brakes, plastic protecting bumpers

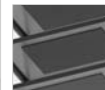

Shelves with noise dampening pads



Heavy duty welded shelves  
Max loading 50 kg/shelf (uniform layout)

*Different dimensions and configurations are available on request.*

Length L, mm	Width B, mm				
	500	550	600	650	700
	Model	Model	Model	Model	Model
700	VTS3-70/50/92	VTS3-70/55/92	VTS3-70/60/92	VTS3-70/65/92	VTS3-70/70/92
750	VTS3-75/50/92	VTS3-75/55/92	VTS3-75/60/92	VTS3-75/65/92	VTS3-75/70/92
800	VTS3-80/50/92	VTS3-80/55/92	VTS3-80/60/92	VTS3-80/65/92	VTS3-80/70/92
850	VTS3-85/50/92	VTS3-85/55/92	VTS3-85/60/92	VTS3-85/65/92	VTS3-85/70/92
900	VTS3-90/50/92	VTS3-90/55/92	VTS3-90/60/92	VTS3-90/65/92	VTS3-90/70/92
950	VTS3-95/50/92	VTS3-95/55/92	VTS3-95/60/92	VTS3-95/65/92	VTS3-95/70/92
1000	VTS3-100/50/92	VTS3-100/55/92	VTS3-100/60/92	VTS3-100/65/92	VTS3-100/70/92
1050	VTS3-105/50/92	VTS3-105/55/92	VTS3-105/60/92	VTS3-105/65/92	VTS3-105/70/92
1100	VTS3-110/50/92	VTS3-110/55/92	VTS3-110/60/92	VTS3-110/65/92	VTS3-110/70/92
1150	VTS3-115/50/92	VTS3-115/55/92	VTS3-115/60/92	VTS3-115/65/92	VTS3-115/70/92
1200	VTS3-120/50/92	VTS3-120/55/92	VTS3-120/60/92	VTS3-120/65/92	VTS3-120/70/92
1250	VTS3-125/50/92	VTS3-125/55/92	VTS3-125/60/92	VTS3-125/65/92	VTS3-125/70/92
1300	VTS3-130/50/92	VTS3-130/55/92	VTS3-130/60/92	VTS3-130/65/92	VTS3-130/70/92

Length L, mm	Width B, mm	
	530	Model
855	VTS3-86/53/92	

### OPTIONAL FEATURES



Set of galvanized wheels Ø125 mm (4 pcs),  
2 pcs with brakes  
Code: K-RAX125-157NCG  
Price: 19 €



Set of stainless steel wheels Ø125mm (4 pcs),  
2 pcs with brakes  
Code: K-RAX125-157NNG  
Price: 103 €

## SERVICE TROLLEY WELDED WITH 4 SHELVES



*Different dimensions and configurations are available on request.*

Length L, mm	Width B, mm				
	500	550	600	650	700
	Model	Model	Model	Model	Model
700	VTS4-70/50/122	VTS4-70/55/122	VTS4-70/60/122	VTS4-70/65/122	VTS4-70/70/122
750	VTS4-75/50/122	VTS4-75/55/122	VTS4-75/60/122	VTS4-75/65/122	VTS4-75/70/122
800	VTS4-80/50/122	VTS4-80/55/122	VTS4-80/60/122	VTS4-80/65/122	VTS4-80/70/122
850	VTS4-85/50/122	VTS4-85/55/122	VTS4-85/60/122	VTS4-85/65/122	VTS4-85/70/122
900	VTS4-90/50/122	VTS4-90/55/122	VTS4-90/60/122	VTS4-90/65/122	VTS4-90/70/122
950	VTS4-95/50/122	VTS4-95/55/122	VTS4-95/60/122	VTS4-95/65/122	VTS4-95/70/122
1000	VTS4-100/50/122	VTS4-100/55/122	VTS4-100/60/122	VTS4-100/65/122	VTS4-100/70/122
1050	VTS4-105/50/122	VTS4-105/55/122	VTS4-105/60/122	VTS4-105/65/122	VTS4-105/70/122
1100	VTS4-110/50/122	VTS4-110/55/122	VTS4-110/60/122	VTS4-110/65/122	VTS4-110/70/122
1150	VTS4-115/50/122	VTS4-115/55/122	VTS4-115/60/122	VTS4-115/65/122	VTS4-115/70/122
1200	VTS4-120/50/122	VTS4-120/55/122	VTS4-120/60/122	VTS4-120/65/122	VTS4-120/70/122
1250	VTS4-125/50/122	VTS4-125/55/122	VTS4-125/60/122	VTS4-125/65/122	VTS4-125/70/122
1300	VTS4-130/50/122	VTS4-130/55/122	VTS4-130/60/122	VTS4-130/65/122	VTS4-130/70/122

### STANDARD FEATURES

#### HEAVY DUTY WELDED SHELVES



Set of galvanized wheels Ø100 mm (4 pcs), 2 pcs with brakes, plastic protecting bumpers

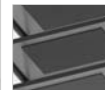

Shelves with noise dampening pads



Heavy duty welded shelves  
Max loading 50 kg/shelf (uniform layout)

### OPTIONAL FEATURES



**Set of galvanized wheels Ø125 mm (4 pcs), 2 pcs with brakes**  
Code: K-RAX125-157NCG  
Price: 19 €



**Set of stainless steel wheels Ø125mm (4 pcs), 2 pcs with brakes**  
Code: K-RAX125-157NNG  
Price: 103 €

## TROLLEY FOR PLATES

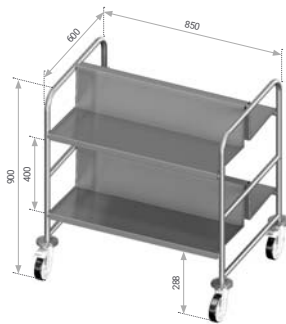

*f* Different dimensions and configurations are available on request. Examples on page 5.30.

Length L, mm	Width B, mm	Model
850	600	VTL2-85/60/90

### DESIGNED FOR PLATES (up to Ø 260 mm)



Set of galvanized wheels Ø125 mm (4 pcs),  
2 pcs with brakes, plastic protecting bumpers



Removable shelves

### OPTIONAL FEATURES



Set of stainless steel wheels Ø125mm (4 pcs),  
2 pcs with brakes

Code: K-RAX125-157NNG

## TRANSPORTATION TROLLEY - PLATFORM

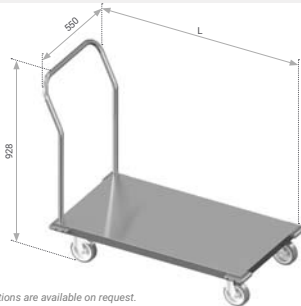

*f* Different dimensions and configurations are available on request. Examples on page 5.30.

Length L, mm	Width B, mm	Model
	550	
600		VTP1-60/55/93
700		VTP1-70/55/93
800		VTP1-80/55/93
900		VTP1-90/55/93
1000		VTP1-100/55/93
1100		VTP1-110/55/93
1200		VTP1-120/55/93

### STANDARD FEATURES

#### HEAVY DUTY CONSTRUCTION WITH REINFORCEMENT PROFILE



Set of heavy duty wheels Ø125 mm (4 pcs),  
2 pcs with brakes



Max loading 200 kg/shelf (uniform layout)



Protecting bumpers

## TROLLEY FOR PLASTIC BAGS



*f* Different dimensions and configurations are available on request. Examples on page 5.30.

Length L, mm	Width B, mm	Model
415	415	VTSM1-42/42/75

### STANDARD FEATURES

HEAVY DUTY WELDED CONSTRUCTION  
DESIGNED FOR PLASTIC BAGS



Set of galvanized wheels Ø75 mm (4 pcs),  
2 pcs with brakes

### OPTIONAL FEATURES



**Stainless steel lid and foot pedal**

Code: VTSM1-02.00 SB



**Lower trolley (height 695 mm)**

Code: H=695

## TROLLEY FOR CUTLERY WITH VALVE

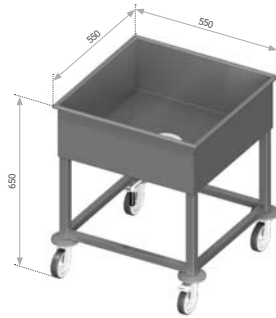

*f* Different dimensions and configurations are available on request. Examples on page 5.30.

Length L, mm	Width B, mm	Dimensions of baskets, mm
550	550	500 x 500
	Model	
	VT11-55/55/65	

### STANDARD FEATURES

HEAVY DUTY WELDED CONSTRUCTION  
DESIGNED FOR DISHWASHER BASKETS  
(500 x 500 mm)



Set of galvanized wheels Ø100 mm (4 pcs),  
2 pcs with brakes, plastic protecting bumpers



Valve

### OPTIONAL FEATURES



**Slide**

Code: VT1-03.00 SB

## DISPENSER TROLLEY FOR DISHWASHER BASKETS

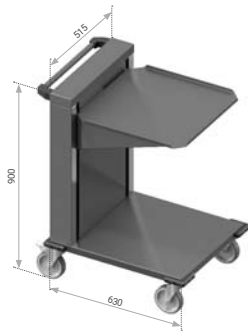

*Different dimensions and configurations are available on request. Examples on page 5.30.*

Model	Dimensions of baskets, mm	Amount of baskets	Max load, kg
VTBD1-52/63/90	500 x 500 x 100	5	50

### DESIGNED FOR DISHWASHER BASKETS (500 x 500 mm)



Set of galvanized wheels Ø125 mm (4 pcs), 2 pcs with brakes, plastic protecting bumpers



Easily removable back panel for spring adjustment

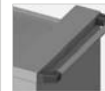

Ergonomic stainless steel handle

#### STANDARD FEATURES

## DISPENSER TROLLEY FOR TRAYS

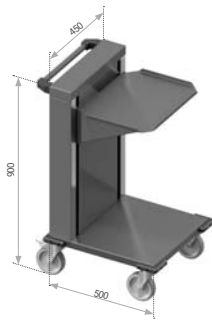

*Different dimensions and configurations are available on request. Examples on page 5.30.*

Model	Dimensions of tray, mm	Amount of trays	Max load, kg
VTTD1-45/50/90	430 x 330	100	50

### DESIGNED FOR TRAYS (430 x 330 mm)



Set of galvanized wheels Ø125 mm (4 pcs), 2 pcs with brakes, plastic protecting bumpers



Easily removable back panel for spring adjustment

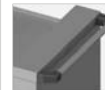

Ergonomic stainless steel handle

#### STANDARD FEATURES



## NEUTRAL DISPENSER TROLLEY FOR PLATES

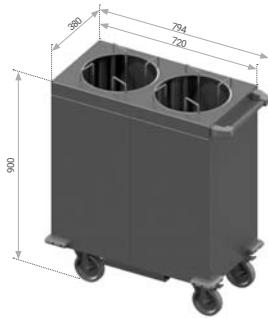

*Different dimensions and configurations are available on request. Examples on page 5.30.*

Model	Diameter of plates, mm	Amount of plates	Max load, kg
VTLD2-38/72/90	160 - 280	2 x 55	2 x 35

### STANDARD FEATURES

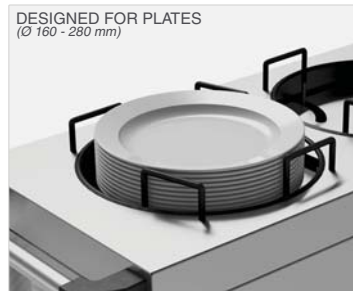

Waste tray



Self adjustable to weight of the plates



Set of galvanized wheels Ø125 mm (4 pcs), 2 pcs with brakes, plastic protecting bumpers

## HEATED DISPENSER TROLLEY FOR PLATES

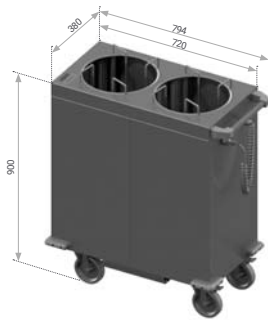

*Different dimensions and configurations are available on request. Examples on page 5.30.*

Model	Diameter of plates, mm	Amount of plates	Max load, kg	Temperature, °C	Input	Power
VTLW2-38/72/90	160 - 280	2 x 55	2 x 35	+30 ... +85	8,7 A	2000 W



### STANDARD FEATURES

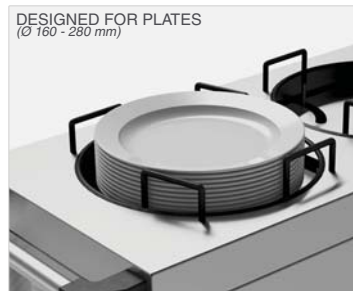

Waste tray



Self adjustable to weight of the plates



Set of galvanized wheels Ø125 mm (4 pcs), 2 pcs with brakes, plastic protecting bumpers



Easy-to-clean digital controller with adjustable temperature (+30 ... +85 °C)



Double-wall construction with thermal insulation



## TERMS AND CONDITIONS



### NOVAMETA STANDARD TERMS

#### Applicability

These Standard Terms ("Terms") apply to all products supplied directly by Novameta to its distributors.

#### Validity of quotations

Quotations are valid for 90 days unless otherwise explicitly stated in the individual quotation. Not responsible for misprints.

#### Delivery terms

Provided in the proforma invoice.  
In case of ex-works (INCOTERMS 2010) Novameta shall not be liable for delays and the distributor shall not be permitted to terminate the purchase due to delays unless agreed to in writing.

#### Payment terms

Provided in the proforma invoice.  
If a higher credit limit is necessary, security is mandatory. Novameta may reduce a credit limit at any time if considered appropriate by Novameta.

#### Storage terms

Provided in the proforma invoice.

#### Retention of Title

Novameta shall retain title in all products and components sold to the distributor until the distributor has paid for the products in full (including transportation and packaging costs).

#### Warranty terms

Novameta provides a Manufacturer's warranty for all of the equipment against defects in materials and workmanship for a period of 1 year from the date of invoicing of the defective product or component to the distributor. Manufacturer undertakes to replace all inferior parts to proper quality parts or materials. In case of a fault, a properly filled claim is required and must contain all essential information relative to the fault. Faulty parts shall be returned to Manufacturer for further inspection.

#### Extended warranty

The extended warranty is solely applicable to certain equipment (indicated in the price list). The extended warranty costs extra of the item's list price. Standard warranty terms apply.

#### Warranty exclusions and limitations of liability

The warranty in these Terms shall be the distributor's exclusive remedy for defective products and components towards Novameta. Novameta shall not be liable for any costs, expenses, losses or claims (whether direct, indirect, consequential or otherwise) relating to defective products or components unless otherwise explicitly stated herein or agreed in writing. Any expenses in connection with the installation or costs of making adjustments (including service procedures, travel time costs) on the equipment to comply with the supply at the point of installation are not covered by this warranty.  
The producer does not take any responsibility for damages that occur due to ignorance of cautions, improper maintenance or mechanical damages of the unit, including those, caused during the delivery. This warranty is not effective if damage occurs from improper installation, misuse, incorrect voltage supply, wear and tear from normal usage, accidental breakage, damage or if the equipment is operated contrary to the user instructions. The warranty does not cover if the damage occurs due to natural disasters, fire, if repair service was made by unauthorized person.  
In case of a failure not covered by the warranty, we provide a possibility to purchase spare parts.

### NOVAMETA STANDARD TERMS

#### Procedure for repair or replacement under the warranty

The distributor shall, at its own costs, make all reasonable attempts to repair any defective component or product.

If such repair is not possible for the distributor, the distributor shall contact Novameta in writing immediately (within 3 working days) upon suspicion of any defects that may be covered by the warranty. If Novameta is not contacted immediately (within 3 working days) in such cases, the distributor shall have no remedies.  
Distributor's contact shall include specific information as to the suspected defect the relevant order number and a copy of the relevant invoice.

After timely receipt of the above, Novameta will decide if there is a defect, whether the claim is covered by the warranty, and whether the product or component is to be replaced.

In cases where Novameta decides to replace defective products or components with new ones, the distributor will be billed the full amount for the goods when they are sent. This amount will then be credited when the defective product or components is returned to Novameta and it is established that the defective product or component is covered by the warranty.  
With regard to the transport of products and components, Novameta will pay the freight of new or repaired products and components, while the distributor will pay the freight for defective goods that are returned (and any other costs related to the return of the goods). The warranty does not cover expenses of the service procedures performed. Novameta does not provide service.

Unless otherwise agreed in writing, the defective product or component should always be returned to Novameta: Draugystės g. 15D, LT-51227 Kaunas, Lithuania.

#### Cancellations

If an order cancellation request is made after confirmation of drawing and proforma invoice, adjustments are not possible and production cannot be stopped. In case of cancellation product will be charged in full.

#### Shipping and packing

Novameta will pack products for shipment in Novameta standard packaging. If the distributor has other requirements as to packing, the distributor shall contact Novameta to make special arrangements.

#### Delivery recommendations

Upon receipt, inspect units immediately for any shipping damage and notify carrier immediately if damage is found. It must be reported immediately (upon delivery) in writing in the CMR. Otherwise neither the Manufacturer nor the carrier can take responsibility for transport damage. All items are thoroughly inspected and carefully packed before leaving our factory, thus Novameta cannot accept responsibility for any shipping damage, however Novameta will assist in filing a claim.

#### Liability and Product liability

Novameta shall only be liable for defects and product liability to the extent set out herein (see particularly warranty terms). In addition to the aforesaid all liability is capped at the invoiced price of the defective product. All other liability is hereby excluded.

#### Choice of law and Venue

These Terms and the cooperation between Novameta and its distributors, including any disputes relating thereto, shall be governed by Lithuanian law.  
Any disputes shall be settled before the Lithuanian courts, which shall have exclusive jurisdiction.

Company No. 235886490, VAT Reg. No. LT 358864917  
Reg. No. 048959, Centre of Registers  
IBAN: LT227300010071982293, Swedbank, AB

REFERENCES AND EXAMPLES OF CUSTOMISED EQUIPMENT



REFERENCES

COMPANY CANTEENS

- Booking.com Headquarters  
Amsterdam, Netherlands
- Novo Nordisk Pharmaceutical Company  
Bagsvaerd, Denmark
- Google Office  
Copenhagen, Denmark
- Michael Kors Distribution Centre  
Venlo, Netherlands
- Samsung Electronics Benelux Office  
Amsterdam, Netherlands
- Nordea Bank Headquarters  
Oslo, Norway
- ING Bank Office  
Amsterdam, Netherlands
- Rabobank Bank  
Eindhoven, Netherlands
- KLM Catering Services Office  
Amsterdam, Netherlands



ZW16-1178

ZE16-5011

EDUCATIONAL INSTITUTIONS

- University of Wolverhampton  
Wolverhampton, United Kingdom
- Copenhagen International School  
Copenhagen, Denmark
- Farmen Barnehage Kindergarten  
Levanger, Norway



ZQ16-5027

ZD16-1148

HOTELS

- Ramada Resort Hadera Beach Hotel  
Hadera, Israel
- Hilton Slussen Hotel  
Stockholm, Sweden
- Kempinski Hotel Cathedral Square  
Vilnius, Lithuania
- Thon Hotel Chain  
Norway
- Tallink City Hotel  
Tallinn, Estonia



ZW16-1047

ZQ16-5044

LEISURE AND LARGE VENUES

- Royal Theatre Carre  
Amsterdam, Netherlands
- LEGOLAND Amusement Park  
Billund, Denmark
- The Well Spa Centre  
Oslo, Norway

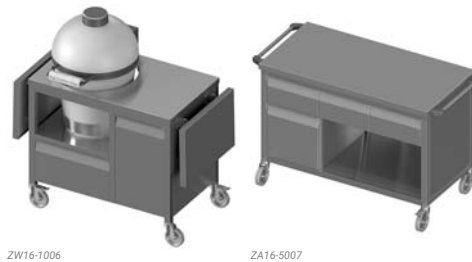

ZW16-1006

ZA16-5007



Z016-2001

ZD17-5003

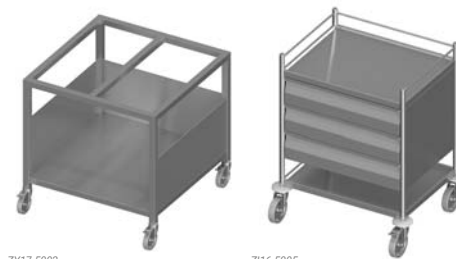

ZY17-5002

Z116-5005

REFERENCES

RESTAURANTS AND BARS

- TGI Fridays Bar & Restaurant  
Sweden
- Chateau Motel Nightclub  
Copenhagen, Denmark
- Happy Italy Restaurants  
Netherlands
- Milu Bar & Restaurant  
The Hague, Netherlands
- Easy Wine Bar  
Riga, Latvia
- Flammen Restaurants  
Denmark
- Bierhuis Restaurant  
Uppsala, Sweden
- Hotcha Restaurant  
Liverpool, United Kingdom

GOVERNMENT & PUBLIC SERVICES

- Ministry of Economic Affairs  
The Hague, Netherlands
- Embassy of Hungary  
Stockholm, Sweden
- Statsfængslet Nordfalster Prison  
Nordtalster, Denmark

HEALTHCARE

- Mare Klinikum Medical Diagnostic Centre  
Kiel, Germany
- Wexham Park Hospital  
Slough, United Kingdom
- Zaans Medical Centre  
Zaandam, Netherlands
- Rikshospitalet Hospital  
Oslo, Norway
- Syrenparken Psychiatric Hospital  
Birkop, Denmark

SHOPS AND SUPERMARKETS

- ICA Supermarkets  
Sweden
- IKEA Stores  
Netherlands, Lithuania
- Coop Supermarkets  
Norway
- Hema Supermarkets  
Netherlands



#### DISHWASHING EQUIPMENT

Wide range of inlet and outlet tables to dishwasher and various customised solutions for sorting lines

#### PROFESSIONAL KITCHEN WORKTABLES

Huge variety of standard and customised worktables for creating an ergonomic and functional workspace for every chef

#### EXHAUST HOODS

Many different configurations of highly efficient hoods featuring cutting-edge technologies of cyclonic filtration, induction jets and laminar flow air supply

#### SHELVES AND CUPBOARDS

Numerous types of wall and upper shelves, wall cabinets, cupboards and shelving systems

#### TROLLEYS

More than 60 types of standard trolleys as well as many more customised variations

#### COOLING COUNTERS AND HEATED EQUIPMENT

More than 1000 models of standard cooling counters, different heated cupboards and upper shelves

#### BAR EQUIPMENT

Unlimited flexibility in unique coffee-station and bar solutions

#### OTHER TABLES AND STANDS

Different stands for all kinds of equipment, hand-wash basins and bakery or food processing tables with cutting boards

#### SERVING LINE EQUIPMENT

Various types of heating and cooling drop-in units, dispensers and shelving together with robust and elegant buffets and counters