

PRODUCT LIST 2017

1. PROFESSIONAL KITCHEN WORKTABLES
2. OTHER TABLES AND STANDS
3. DISHWASHING EQUIPMENT
- 4. SHELVES AND CUPBOARDS**
5. TROLLEYS
6. EXHAUST HOODS
7. BAR EQUIPMENT
8. SERVING LINE EQUIPMENT
9. COOLING COUNTERS AND HEATED EQUIPMENT
10. MODULAR TABLES

YOUR RELIABLE PARTNER

Novameta is the largest and most advanced manufacturer of stainless steel commercial kitchen equipment in Baltic and Scandinavian countries. Extensive 16-year experience, attention to details along with an innovative mindset are the key factors which have enabled Novameta to establish trust in 18 markets throughout Europe.

A wide range of hot, cold and neutral standard equipment, precisely engineered and crafted non-standard products combined with a short, typically 2-4 week lead time is what makes us stand out of the crowd. What is more, our experienced team is all set to provide professional support and technical advice, enabling our clients to turn their ideas to tailor made turnkey solutions.

All of our products are marketed through a professional network of distributors throughout Europe. We are proud to provide an all-round assistance to our dealers, helping them to excel in the things they do best - planning, taking care of supply, installation and service to fulfil the needs of catering, bakery and retail industries.

Our main objectives are to maintain solid positions in Europe through sustaining partnership relationships with our clients, whilst at the same time expanding into new markets worldwide. Experienced and ambitious sales team, application of up-to-date 3D CAD software in our in-house design department, employment of latest production technologies and LEAN quality management based on ISO 9001:2000 standard, have determined the rapid expansion of our sales markets and therefore the consequent quick growth of the company.

Currently, over 165 employees work in the enterprise and the production area covers 5000 m². Novameta manufactures over 180 different items every day, more than 1000 projects yearly!



Novameta
 Draugystės g. 15D, LT-51227 Kaunas, Lithuania
 + 370 37 30 23 30
 novameta@novameta.lt
 www.novameta.lt

Novameta UK
 1210 Parkview, Arfington Business Park, Thesale, Reading, Berkshire RG7 4TY, UK
 +44 118 965 4098
 +44 791 874 0027
 sales@novameta.co.uk
 www.novameta.co.uk

CONTENTS

	STL4	REINFORCED SHELVES WELDED.....	4.4
	STP4	PERFORATED SHELVES WELDED.....	4.6
	STS4	GRID SHELVES WELDED.....	4.8
	SRL4	MODULAR SHELVING UNIT WITH STAINLESS STEEL PLATE SHELVES.....	4.10
	SRN4	MODULAR SHELVING UNIT WITH REMOVABLE STAINLESS STEEL PLATE SHELVES.....	4.12
	SRM4	MODULAR SHELVING UNIT WITH REMOVABLE PLASTIC SHELVES.....	4.14
	LPL1	UPPER SHELF FOR TABLE SINGLE.....	4.16
	LPL2	UPPER SHELF FOR TABLE DOUBLE.....	4.18
	LSL1	WALL SHELF SINGLE.....	4.20
	LSL2	WALL SHELF DOUBLE.....	4.22
	LSL3	WALL SHELF TRIPLE.....	4.24
	LSI1	WALL SHELF FOR EQUIPMENT SINGLE.....	4.26
	LSI2	WALL SHELF FOR EQUIPMENT DOUBLE.....	4.28
	LSI3	WALL SHELF FOR EQUIPMENT TRIPLE.....	4.30
	LSD2	DISH DRYING WALL SHELF DOUBLE.....	4.32
	LSD3	DISH DRYING WALL SHELF DOUBLE WITH DRIP TRAY.....	4.32
	LSB1	SHELF FOR DISHWASHER BASKETS.....	4.34
	LSV1	FOLDED WALL SHELF SINGLE.....	4.34
	CKS2	WALL CABINET WITH SLIDING DOORS.....	4.36
	CKV2	WALL CABINET WITH SHUTTING DOORS.....	4.38
	CPS4	CUPBOARD WITH SLIDING DOORS.....	4.40
	CPV4	CUPBOARD WITH SHUTTING DOORS.....	4.42
	CCV4	CUPBOARD FOR CLEANING EQUIPMENT.....	4.44
		ADDITIONAL ACCESSORIES.....	4.46
		TERMS AND CONDITIONS.....	4.48
		REFERENCES AND EXAMPLES OF CUSTOMISED EQUIPMENT.....	4.50

REINFORCED SHELVES WELDED

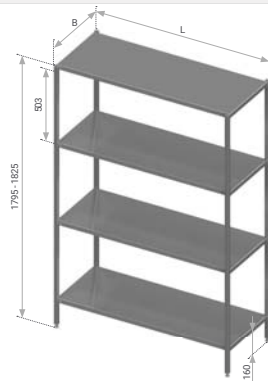

f Different dimensions and configurations are available on request. Examples on page 4.50.

Length L, mm	Width B, mm				Legs
	400	500	600	700	
	Model	Model	Model	Model	
600	STL4-60/40/180	STL4-60/50/180	STL4-60/60/180	STL4-60/70/180	4
700	STL4-70/40/180	STL4-70/50/180	STL4-70/60/180	STL4-70/70/180	4
800	STL4-80/40/180	STL4-80/50/180	STL4-80/60/180	STL4-80/70/180	4
900	STL4-90/40/180	STL4-90/50/180	STL4-90/60/180	STL4-90/70/180	4
1000	STL4-100/40/180	STL4-100/50/180	STL4-100/60/180	STL4-100/70/180	4
1100	STL4-110/40/180	STL4-110/50/180	STL4-110/60/180	STL4-110/70/180	4
1200	STL4-120/40/180	STL4-120/50/180	STL4-120/60/180	STL4-120/70/180	4
1300	STL4-130/40/180	STL4-130/50/180	STL4-130/60/180	STL4-130/70/180	4
1400	STL4-140/40/180	STL4-140/50/180	STL4-140/60/180	STL4-140/70/180	4
1500	STL4-150/40/180	STL4-150/50/180	STL4-150/60/180	STL4-150/70/180	4
1600	STL4-160/40/180	STL4-160/50/180	STL4-160/60/180	STL4-160/70/180	4
1700	STL4-170/40/180	STL4-170/50/180	STL4-170/60/180	STL4-170/70/180	4
1800	STL4-180/40/180	STL4-180/50/180	STL4-180/60/180	STL4-180/70/180	4
1900	STL4-190/40/180	STL4-190/50/180	STL4-190/60/180	STL4-190/70/180	4
2000	STL4-200/40/180	STL4-200/50/180	STL4-200/60/180	STL4-200/70/180	4
2100	STL4-210/40/180	STL4-210/50/180	STL4-210/60/180	STL4-210/70/180	6
2200	STL4-220/40/180	STL4-220/50/180	STL4-220/60/180	STL4-220/70/180	6
2300	STL4-230/40/180	STL4-230/50/180	STL4-230/60/180	STL4-230/70/180	6
2400	STL4-240/40/180	STL4-240/50/180	STL4-240/60/180	STL4-240/70/180	6
2500	STL4-250/40/180	STL4-250/50/180	STL4-250/60/180	STL4-250/70/180	6
2600	STL4-260/40/180	STL4-260/50/180	STL4-260/60/180	STL4-260/70/180	6
2700	STL4-270/40/180	STL4-270/50/180	STL4-270/60/180	STL4-270/70/180	6
2800	STL4-280/40/180	STL4-280/50/180	STL4-280/60/180	STL4-280/70/180	6
2900	STL4-290/40/180	STL4-290/50/180	STL4-290/60/180	STL4-290/70/180	6

STANDARD FEATURES

HEAVY DUTY WELDED CONSTRUCTION

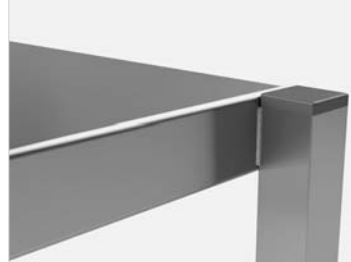

Adjustable hard plastic feet
(amplitude 30 mm +25/-5)



Welded frame
Legs made of stainless steel tube 25 x 25 mm
Max loading 120 kg/shelf (uniform layout)

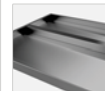

Shelf made with reinforcement profile

OPTIONAL FEATURES

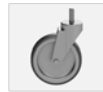

Set of galvanized wheels Ø125 mm,
2 pcs with brakes

Code: A-ST-RC125



Set of stainless steel wheels Ø125mm,
2 pcs with brakes

Code: A-ST-RN125

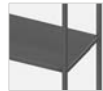

Additional shelf

Code: STL5



Customised layout of shelves

Code: A-ST-PE



Side panel

Code: A-STU-K (left)
A-STU-D (right)



Rear panel

Code: A-STU-G
Note: 2 parts from 1600 mm

PERFORATED SHELVES WELDED

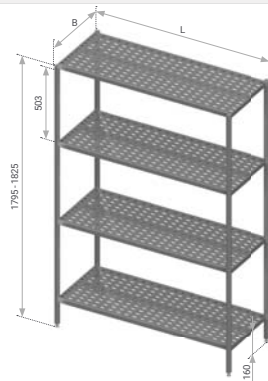

f Different dimensions and configurations are available on request. Examples on page 4.50.

Length L, mm	Width B, mm				Legs
	400	500	600	700	
	Model	Model	Model	Model	
600	STP4-60/40/180	STP4-60/50/180	STP4-60/60/180	STP4-60/70/180	4
700	STP4-70/40/180	STP4-70/50/180	STP4-70/60/180	STP4-70/70/180	4
800	STP4-80/40/180	STP4-80/50/180	STP4-80/60/180	STP4-80/70/180	4
900	STP4-90/40/180	STP4-90/50/180	STP4-90/60/180	STP4-90/70/180	4
1000	STP4-100/40/180	STP4-100/50/180	STP4-100/60/180	STP4-100/70/180	4
1100	STP4-110/40/180	STP4-110/50/180	STP4-110/60/180	STP4-110/70/180	4
1200	STP4-120/40/180	STP4-120/50/180	STP4-120/60/180	STP4-120/70/180	4
1300	STP4-130/40/180	STP4-130/50/180	STP4-130/60/180	STP4-130/70/180	4
1400	STP4-140/40/180	STP4-140/50/180	STP4-140/60/180	STP4-140/70/180	4
1500	STP4-150/40/180	STP4-150/50/180	STP4-150/60/180	STP4-150/70/180	4
1600	STP4-160/40/180	STP4-160/50/180	STP4-160/60/180	STP4-160/70/180	4
1700	STP4-170/40/180	STP4-170/50/180	STP4-170/60/180	STP4-170/70/180	4
1800	STP4-180/40/180	STP4-180/50/180	STP4-180/60/180	STP4-180/70/180	4
1900	STP4-190/40/180	STP4-190/50/180	STP4-190/60/180	STP4-190/70/180	4
2000	STP4-200/40/180	STP4-200/50/180	STP4-200/60/180	STP4-200/70/180	4
2100	STP4-210/40/180	STP4-210/50/180	STP4-210/60/180	STP4-210/70/180	6
2200	STP4-220/40/180	STP4-220/50/180	STP4-220/60/180	STP4-220/70/180	6
2300	STP4-230/40/180	STP4-230/50/180	STP4-230/60/180	STP4-230/70/180	6
2400	STP4-240/40/180	STP4-240/50/180	STP4-240/60/180	STP4-240/70/180	6
2500	STP4-250/40/180	STP4-250/50/180	STP4-250/60/180	STP4-250/70/180	6
2600	STP4-260/40/180	STP4-260/50/180	STP4-260/60/180	STP4-260/70/180	6
2700	STP4-270/40/180	STP4-270/50/180	STP4-270/60/180	STP4-270/70/180	6
2800	STP4-280/40/180	STP4-280/50/180	STP4-280/60/180	STP4-280/70/180	6
2900	STP4-290/40/180	STP4-290/50/180	STP4-290/60/180	STP4-290/70/180	6

STANDARD FEATURES

PERFORATED SHELF

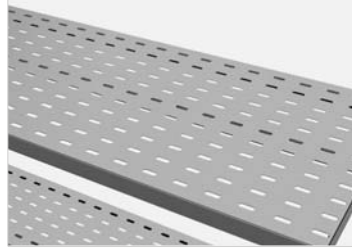

Adjustable hard plastic feet
(amplitude 30 mm +25/-5)



Welded frame
Legs made of stainless steel tube 25 x 25 mm
Max loading 120 kg/shelf (uniform layout)



Shelf made with reinforcement profile

OPTIONAL FEATURES



Set of galvanized wheels Ø125 mm,
2 pcs with brakes

Code: A-ST-RC125



Set of stainless steel wheels Ø125mm,
2 pcs with brakes

Code: A-ST-RN125



Additional shelf

Code: STP5

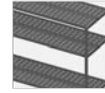

Customised layout of shelves

Code: A-ST-PE



Side panel

Code: A-STU-K (left)
A-STU-D (right)



Rear panel

Code: A-STU-G
Note: 2 parts from 1600 mm

GRID SHELVES WELDED

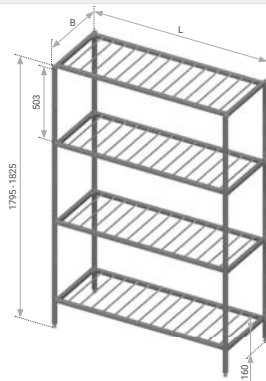

f Different dimensions and configurations are available on request. Examples on page 4.50.

Length L, mm	Width B, mm				Legs
	400 Model	500 Model	600 Model	700 Model	
600	STS4-60/40/180	STS4-60/50/180	STS4-60/60/180	STS4-60/70/180	4
700	STS4-70/40/180	STS4-70/50/180	STS4-70/60/180	STS4-70/70/180	4
800	STS4-80/40/180	STS4-80/50/180	STS4-80/60/180	STS4-80/70/180	4
900	STS4-90/40/180	STS4-90/50/180	STS4-90/60/180	STS4-90/70/180	4
1000	STS4-100/40/180	STS4-100/50/180	STS4-100/60/180	STS4-100/70/180	4
1100	STS4-110/40/180	STS4-110/50/180	STS4-110/60/180	STS4-110/70/180	4
1200	STS4-120/40/180	STS4-120/50/180	STS4-120/60/180	STS4-120/70/180	4
1300	STS4-130/40/180	STS4-130/50/180	STS4-130/60/180	STS4-130/70/180	4
1400	STS4-140/40/180	STS4-140/50/180	STS4-140/60/180	STS4-140/70/180	4
1500	STS4-150/40/180	STS4-150/50/180	STS4-150/60/180	STS4-150/70/180	4
1600	STS4-160/40/180	STS4-160/50/180	STS4-160/60/180	STS4-160/70/180	4
1700	STS4-170/40/180	STS4-170/50/180	STS4-170/60/180	STS4-170/70/180	4
1800	STS4-180/40/180	STS4-180/50/180	STS4-180/60/180	STS4-180/70/180	4
1900	STS4-190/40/180	STS4-190/50/180	STS4-190/60/180	STS4-190/70/180	4
2000	STS4-200/40/180	STS4-200/50/180	STS4-200/60/180	STS4-200/70/180	4
2100	STS4-210/40/180	STS4-210/50/180	STS4-210/60/180	STS4-210/70/180	6
2200	STS4-220/40/180	STS4-220/50/180	STS4-220/60/180	STS4-220/70/180	6
2300	STS4-230/40/180	STS4-230/50/180	STS4-230/60/180	STS4-230/70/180	6
2400	STS4-240/40/180	STS4-240/50/180	STS4-240/60/180	STS4-240/70/180	6
2500	STS4-250/40/180	STS4-250/50/180	STS4-250/60/180	STS4-250/70/180	6
2600	STS4-260/40/180	STS4-260/50/180	STS4-260/60/180	STS4-260/70/180	6
2700	STS4-270/40/180	STS4-270/50/180	STS4-270/60/180	STS4-270/70/180	6
2800	STS4-280/40/180	STS4-280/50/180	STS4-280/60/180	STS4-280/70/180	6
2900	STS4-290/40/180	STS4-290/50/180	STS4-290/60/180	STS4-290/70/180	6

HEAVY DUTY WELDED CONSTRUCTION



STANDARD FEATURES



Adjustable hard plastic feet
(amplitude 30 mm +25/-5)



Welded frame
Legs made of stainless steel tube 25 x 25 mm
Max loading 120 kg/shelf (uniform layout)

OPTIONAL FEATURES



Set of galvanized wheels Ø125 mm,
2 pcs with brakes

Code: A-ST-RC125



Set of stainless steel wheels Ø125mm,
2 pcs with brakes

Code: A-ST-RN125



Additional shelf

Code: STSS

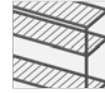

Customised layout of shelves

Code: A-ST-PE



Side panel

Code: A-STU-K (left)
A-STU-D (right)



Rear panel

Code: A-STU-G
Note: 2 parts from 1600 mm

MODULAR SHELVING UNIT WITH STAINLESS STEEL PLATE SHELVES

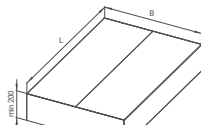

Comes flat packed

STANDARD FEATURES



Adjustable hard plastic feet (amplitude 30 mm +20/-10)



Legs made of stainless steel tube 30 x 30 mm
Max loading 120 kg/shelf (uniform layout)

f Different dimensions and configurations are available on request. Examples on page 4.50.

Length L, mm	Width B, mm			Legs
	400	508	600	
600	SRL4-60/40/180	SRL4-60/51/180	SRL4-60/60/180	4
700	SRL4-70/40/180	SRL4-70/51/180	SRL4-70/60/180	4
800	SRL4-80/40/180	SRL4-80/51/180	SRL4-80/60/180	4
900	SRL4-90/40/180	SRL4-90/51/180	SRL4-90/60/180	4
1000	SRL4-100/40/180	SRL4-100/51/180	SRL4-100/60/180	4
1100	SRL4-110/40/180	SRL4-110/51/180	SRL4-110/60/180	4
1200	SRL4-120/40/180	SRL4-120/51/180	SRL4-120/60/180	4
1300	SRL4-130/40/180	SRL4-130/51/180	SRL4-130/60/180	4
1400	SRL4-140/40/180	SRL4-140/51/180	SRL4-140/60/180	4
1500	SRL4-150/40/180	SRL4-150/51/180	SRL4-150/60/180	4
1600	SRL4-160/40/180	SRL4-160/51/180	SRL4-160/60/180	4
1700	SRL4-170/40/180	SRL4-170/51/180	SRL4-170/60/180	4
1800	SRL4-180/40/180	SRL4-180/51/180	SRL4-180/60/180	4
1900	SRL4-190/40/180	SRL4-190/51/180	SRL4-190/60/180	6
2000	SRL4-200/40/180	SRL4-200/51/180	SRL4-200/60/180	6
2100	SRL4-210/40/180	SRL4-210/51/180	SRL4-210/60/180	6
2200	SRL4-220/40/180	SRL4-220/51/180	SRL4-220/60/180	6
2300	SRL4-230/40/180	SRL4-230/51/180	SRL4-230/60/180	6
2400	SRL4-240/40/180	SRL4-240/51/180	SRL4-240/60/180	6
2500	SRL4-250/40/180	SRL4-250/51/180	SRL4-250/60/180	6
2600	SRL4-260/40/180	SRL4-260/51/180	SRL4-260/60/180	6
2700	SRL4-270/40/180	SRL4-270/51/180	SRL4-270/60/180	6
2800	SRL4-280/40/180	SRL4-280/51/180	SRL4-280/60/180	6
2900	SRL4-290/40/180	SRL4-290/51/180	SRL4-290/60/180	6
3000	SRL4-300/40/180	SRL4-300/51/180	SRL4-300/60/180	6
3100	SRL4-310/40/180	SRL4-310/51/180	SRL4-310/60/180	6
3200	SRL4-320/40/180	SRL4-320/51/180	SRL4-320/60/180	6
3300	SRL4-330/40/180	SRL4-330/51/180	SRL4-330/60/180	6
3400	SRL4-340/40/180	SRL4-340/51/180	SRL4-340/60/180	6
3500	SRL4-350/40/180	SRL4-350/51/180	SRL4-350/60/180	6
3600	SRL4-360/40/180	SRL4-360/51/180	SRL4-360/60/180	6

OPTIONAL FEATURES



Additional shelf

Code: SRL5



Lower shelving unit (height 1600 mm)

Code: H=1600

MODULAR SHELVING UNIT WITH REMOVABLE STAINLESS STEEL PLATE SHELVES

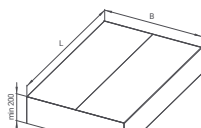
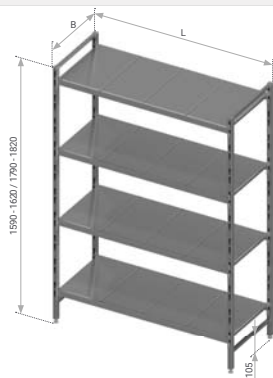

Comes flat packed

STANDARD FEATURES

EASY TO ASSEMBLE



Adjustable hard plastic feet (amplitude 30 mm +20/-10)



Legs made of stainless steel tube 30 x 30 mm
Max loading 30 kg/shelf (uniform layout)

f Different dimensions and configurations are available on request. Examples on page 4.50.

Length L, mm	Width B, mm			Legs
	400	508	600	
	Model	Model	Model	
960	SRN4-96/40/180	SRN4-96/51/180	SRN4-96/60/180	4
1260	SRN4-126/40/180	SRN4-126/51/180	SRN4-126/60/180	4
1560	SRN4-156/40/180	SRN4-156/51/180	SRN4-156/60/180	4
1860	SRN4-186/40/180	SRN4-186/51/180	SRN4-186/60/180	4
2190	SRN4-219/40/180	SRN4-219/51/180	SRN4-219/60/180	6
2490	SRN4-249/40/180	SRN4-249/51/180	SRN4-249/60/180	6
2790	SRN4-279/40/180	SRN4-279/51/180	SRN4-279/60/180	6
3090	SRN4-309/40/180	SRN4-309/51/180	SRN4-309/60/180	6
3390	SRN4-339/40/180	SRN4-339/51/180	SRN4-339/60/180	6
3690	SRN4-369/40/180	SRN4-369/51/180	SRN4-369/60/180	6

OPTIONAL FEATURES



Additional shelf

Code: SRN5



Lower shelving unit (height 1600 mm)

Code: H=1600

MODULAR SHELVING UNIT WITH REMOVABLE PLASTIC SHELVES

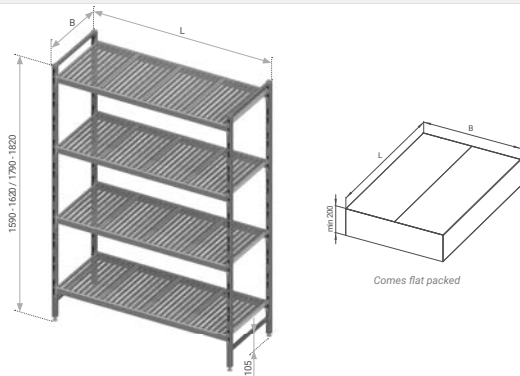

f Different dimensions and configurations are available on request. Examples on page 4.50.

Length L, mm	Width B, mm		Legs
	508		
	Model		
960	SRM4-96/S1/180		4
1260	SRM4-126/S1/180		4
1560	SRM4-156/S1/180		4
1860	SRM4-186/S1/180		4
2190	SRM4-219/S1/180		6
2490	SRM4-249/S1/180		6
2790	SRM4-279/S1/180		6
3090	SRM4-309/S1/180		6
3390	SRM4-339/S1/180		6
3690	SRM4-369/S1/180		6

STANDARD FEATURES

EASY TO ASSEMBLE

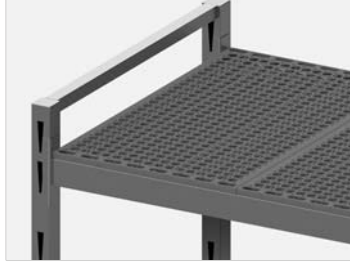

Adjustable hard plastic feet (amplitude 30 mm +20/-10)



Legs made of stainless steel tube 30 x 30 mm
Max loading 30 kg/shelf (uniform layout)



Suitable for use in cold rooms (-30 ... 0 °C)
(with A-MSL-M shelves)

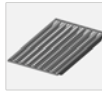

Plastic shelf (297 x 497 mm)

Choose:
A-MSL-M (blue) for 0 ... +30 °C or
A-MSL-Z (green) for -30 ... 0 °C

OPTIONAL FEATURES

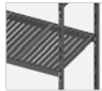

Additional shelf

Code: SRMS



Lower shelving unit (height 1600 mm)

Code: H=1600

UPPER SHELF FOR TABLE SINGLE

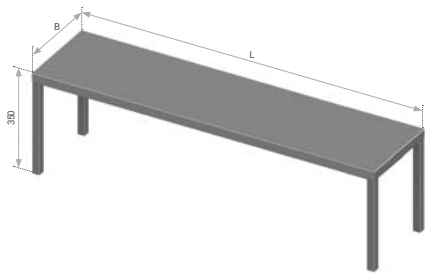

STANDARD FEATURES



HYGIENIC WELDING



Easy to assemble. Suitable for all kinds of tables



Max loading 30 kg/shelf (uniform layout)

f Different dimensions and configurations are available on request. Examples on page 4.50.

Length L, mm	Width B, mm		Legs
	300	400	
	Model	Model	
800	LPL1-80/30/35	LPL1-80/40/35	4
900	LPL1-90/30/35	LPL1-90/40/35	4
1000	LPL1-100/30/35	LPL1-100/40/35	4
1100	LPL1-110/30/35	LPL1-110/40/35	4
1200	LPL1-120/30/35	LPL1-120/40/35	4
1300	LPL1-130/30/35	LPL1-130/40/35	4
1400	LPL1-140/30/35	LPL1-140/40/35	4
1500	LPL1-150/30/35	LPL1-150/40/35	4
1600	LPL1-160/30/35	LPL1-160/40/35	4
1700	LPL1-170/30/35	LPL1-170/40/35	4
1800	LPL1-180/30/35	LPL1-180/40/35	4
1900	LPL1-190/30/35	LPL1-190/40/35	4
2000	LPL1-200/30/35	LPL1-200/40/35	4
2100	LPL1-210/30/35	LPL1-210/40/35	6
2200	LPL1-220/30/35	LPL1-220/40/35	6
2300	LPL1-230/30/35	LPL1-230/40/35	6
2400	LPL1-240/30/35	LPL1-240/40/35	6
2500	LPL1-250/30/35	LPL1-250/40/35	6
2600	LPL1-260/30/35	LPL1-260/40/35	6
2700	LPL1-270/30/35	LPL1-270/40/35	6
2800	LPL1-280/30/35	LPL1-280/40/35	6
2900	LPL1-290/30/35	LPL1-290/40/35	6

OPTIONAL FEATURES



Reinforcement profile
Code: V-N-30x30



Customised shelf height
Code: Z-HEIGHT



Side panel
Code: A-LPTU-K (left)
A-LPTU-D (right)



Rear panel
Code: A-LPTU-G
Note: 2 parts from 2100 mm



Ceiling mounting
Code: Z-CEILING



Ceiling mounting with adjustable height
(amplitude 250 mm ±230/-4)
Code: Z-ADJUSTABLE

UPPER SHELF FOR TABLE DOUBLE

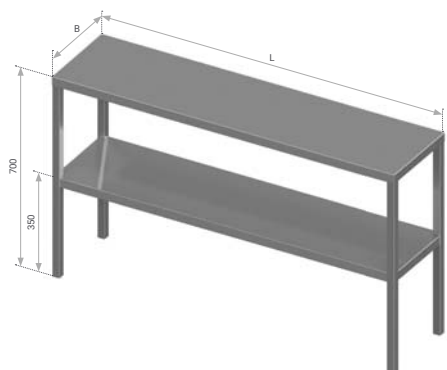

f Different dimensions and configurations are available on request. Examples on page 4.50.

Length L, mm	Width B, mm		Legs
	300	400	
800	LPL2-80/30/70	LPL2-80/40/70	4
900	LPL2-90/30/70	LPL2-90/40/70	4
1000	LPL2-100/30/70	LPL2-100/40/70	4
1100	LPL2-110/30/70	LPL2-110/40/70	4
1200	LPL2-120/30/70	LPL2-120/40/70	4
1300	LPL2-130/30/70	LPL2-130/40/70	4
1400	LPL2-140/30/70	LPL2-140/40/70	4
1500	LPL2-150/30/70	LPL2-150/40/70	4
1600	LPL2-160/30/70	LPL2-160/40/70	4
1700	LPL2-170/30/70	LPL2-170/40/70	4
1800	LPL2-180/30/70	LPL2-180/40/70	4
1900	LPL2-190/30/70	LPL2-190/40/70	4
2000	LPL2-200/30/70	LPL2-200/40/70	4
2100	LPL2-210/30/70	LPL2-210/40/70	6
2200	LPL2-220/30/70	LPL2-220/40/70	6
2300	LPL2-230/30/70	LPL2-230/40/70	6
2400	LPL2-240/30/70	LPL2-240/40/70	6
2500	LPL2-250/30/70	LPL2-250/40/70	6
2600	LPL2-260/30/70	LPL2-260/40/70	6
2700	LPL2-270/30/70	LPL2-270/40/70	6
2800	LPL2-280/30/70	LPL2-280/40/70	6
2900	LPL2-290/30/70	LPL2-290/40/70	6

HYGIENIC WELDING



STANDARD FEATURES



Easy to assemble. Suitable for all kinds of tables



Max loading 30 kg/shelf (uniform layout)

OPTIONAL FEATURES



Reinforcement profile
Code: V-N-30x30

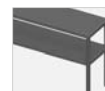

Customised layout of shelves
Code: A-L-PE



Side panel
Code: A-LP2U-K (left)
A-LP2U-D (right)



Rear panel
Code: A-LP2U-G
Note: 2 parts from 2100 mm



Ceiling mounting
Code: Z-CEILING



Ceiling mounting with adjustable height (amplitude 250 mm +230/-4)
Code: Z-ADJUSTABLE

WALL SHELF SINGLE

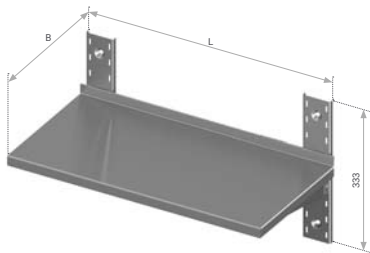

STANDARD FEATURES

EASY TO ASSEMBLE
(bracket thickness 10 mm)

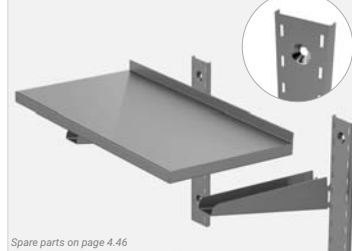

Spare parts on page 4.46



Easy to change height of the shelf



Heavy duty double bracket



Max loading 40 kg/shelf (uniform layout)

f Different dimensions and configurations are available on request. Examples on page 4.50.

Length L, mm	Width B, mm			Brackets
	300	400	500	
500	LSL-1-50/30/33	LSL-1-50/40/33	LSL-1-50/50/33	2
600	LSL-1-60/30/33	LSL-1-60/40/33	LSL-1-60/50/33	2
700	LSL-1-70/30/33	LSL-1-70/40/33	LSL-1-70/50/33	2
800	LSL-1-80/30/33	LSL-1-80/40/33	LSL-1-80/50/33	2
900	LSL-1-90/30/33	LSL-1-90/40/33	LSL-1-90/50/33	2
1000	LSL-1-100/30/33	LSL-1-100/40/33	LSL-1-100/50/33	2
1100	LSL-1-110/30/33	LSL-1-110/40/33	LSL-1-110/50/33	2
1200	LSL-1-120/30/33	LSL-1-120/40/33	LSL-1-120/50/33	2
1300	LSL-1-130/30/33	LSL-1-130/40/33	LSL-1-130/50/33	2
1400	LSL-1-140/30/33	LSL-1-140/40/33	LSL-1-140/50/33	2
1500	LSL-1-150/30/33	LSL-1-150/40/33	LSL-1-150/50/33	2
1600	LSL-1-160/30/33	LSL-1-160/40/33	LSL-1-160/50/33	3
1700	LSL-1-170/30/33	LSL-1-170/40/33	LSL-1-170/50/33	3
1800	LSL-1-180/30/33	LSL-1-180/40/33	LSL-1-180/50/33	3
1900	LSL-1-190/30/33	LSL-1-190/40/33	LSL-1-190/50/33	3
2000	LSL-1-200/30/33	LSL-1-200/40/33	LSL-1-200/50/33	3
2100	LSL-1-210/30/33	LSL-1-210/40/33	LSL-1-210/50/33	3
2200	LSL-1-220/30/33	LSL-1-220/40/33	LSL-1-220/50/33	3
2300	LSL-1-230/30/33	LSL-1-230/40/33	LSL-1-230/50/33	3
2400	LSL-1-240/30/33	LSL-1-240/40/33	LSL-1-240/50/33	3
2500	LSL-1-250/30/33	LSL-1-250/40/33	LSL-1-250/50/33	4
2600	LSL-1-260/30/33	LSL-1-260/40/33	LSL-1-260/50/33	4
2700	LSL-1-270/30/33	LSL-1-270/40/33	LSL-1-270/50/33	4
2800	LSL-1-280/30/33	LSL-1-280/40/33	LSL-1-280/50/33	4
2900	LSL-1-290/30/33	LSL-1-290/40/33	LSL-1-290/50/33	4

OPTIONAL FEATURES



Wall brackets 30 mm thick (2 pcs.)

Code: LSL-00.03

WALL SHELF DOUBLE

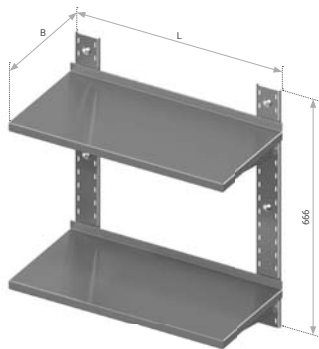

STANDARD FEATURES

EASY TO ASSEMBLE
(bracket thickness 10 mm)



Spare parts on page 4.46



Easy to change height of the shelf



Heavy duty double bracket



Max loading 40 kg/shelf (uniform layout)

f Different dimensions and configurations are available on request. Examples on page 4.50.

Length L, mm	Width B, mm			Brackets
	300	400	500	
500	LSL2-50/30/66	LSL2-50/40/66	LSL2-50/50/66	2
600	LSL2-60/30/66	LSL2-60/40/66	LSL2-60/50/66	2
700	LSL2-70/30/66	LSL2-70/40/66	LSL2-70/50/66	2
800	LSL2-80/30/66	LSL2-80/40/66	LSL2-80/50/66	2
900	LSL2-90/30/66	LSL2-90/40/66	LSL2-90/50/66	2
1000	LSL2-100/30/66	LSL2-100/40/66	LSL2-100/50/66	2
1100	LSL2-110/30/66	LSL2-110/40/66	LSL2-110/50/66	2
1200	LSL2-120/30/66	LSL2-120/40/66	LSL2-120/50/66	2
1300	LSL2-130/30/66	LSL2-130/40/66	LSL2-130/50/66	2
1400	LSL2-140/30/66	LSL2-140/40/66	LSL2-140/50/66	2
1500	LSL2-150/30/66	LSL2-150/40/66	LSL2-150/50/66	2
1600	LSL2-160/30/66	LSL2-160/40/66	LSL2-160/50/66	3
1700	LSL2-170/30/66	LSL2-170/40/66	LSL2-170/50/66	3
1800	LSL2-180/30/66	LSL2-180/40/66	LSL2-180/50/66	3
1900	LSL2-190/30/66	LSL2-190/40/66	LSL2-190/50/66	3
2000	LSL2-200/30/66	LSL2-200/40/66	LSL2-200/50/66	3
2100	LSL2-210/30/66	LSL2-210/40/66	LSL2-210/50/66	3
2200	LSL2-220/30/66	LSL2-220/40/66	LSL2-220/50/66	3
2300	LSL2-230/30/66	LSL2-230/40/66	LSL2-230/50/66	3
2400	LSL2-240/30/66	LSL2-240/40/66	LSL2-240/50/66	3
2500	LSL2-250/30/66	LSL2-250/40/66	LSL2-250/50/66	4
2600	LSL2-260/30/66	LSL2-260/40/66	LSL2-260/50/66	4
2700	LSL2-270/30/66	LSL2-270/40/66	LSL2-270/50/66	4
2800	LSL2-280/30/66	LSL2-280/40/66	LSL2-280/50/66	4
2900	LSL2-290/30/66	LSL2-290/40/66	LSL2-290/50/66	4

OPTIONAL FEATURES



Wall brackets 30 mm thick (2 pcs.)

Code: LSL-00.03

WALL SHELF TRIPLE



STANDARD FEATURES

EASY TO ASSEMBLE
(bracket thickness 10 mm)



Spare parts on page 4.46



Easy to change height of the shelf



Heavy duty double bracket



Max loading 40 kg/shelf (uniform layout)

f Different dimensions and configurations are available on request. Examples on page 4.50.

Length L, mm	Width B, mm			Brackets
	300	400	500	
500	LSL3-50/30/99	LSL3-50/40/99	LSL3-50/50/99	2
600	LSL3-60/30/99	LSL3-60/40/99	LSL3-60/50/99	2
700	LSL3-70/30/99	LSL3-70/40/99	LSL3-70/50/99	2
800	LSL3-80/30/99	LSL3-80/40/99	LSL3-80/50/99	2
900	LSL3-90/30/99	LSL3-90/40/99	LSL3-90/50/99	2
1000	LSL3-100/30/99	LSL3-100/40/99	LSL3-100/50/99	2
1100	LSL3-110/30/99	LSL3-110/40/99	LSL3-110/50/99	2
1200	LSL3-120/30/99	LSL3-120/40/99	LSL3-120/50/99	2
1300	LSL3-130/30/99	LSL3-130/40/99	LSL3-130/50/99	2
1400	LSL3-140/30/99	LSL3-140/40/99	LSL3-140/50/99	2
1500	LSL3-150/30/99	LSL3-150/40/99	LSL3-150/50/99	2
1600	LSL3-160/30/99	LSL3-160/40/99	LSL3-160/50/99	3
1700	LSL3-170/30/99	LSL3-170/40/99	LSL3-170/50/99	3
1800	LSL3-180/30/99	LSL3-180/40/99	LSL3-180/50/99	3
1900	LSL3-190/30/99	LSL3-190/40/99	LSL3-190/50/99	3
2000	LSL3-200/30/99	LSL3-200/40/99	LSL3-200/50/99	3
2100	LSL3-210/30/99	LSL3-210/40/99	LSL3-210/50/99	3
2200	LSL3-220/30/99	LSL3-220/40/99	LSL3-220/50/99	3
2300	LSL3-230/30/99	LSL3-230/40/99	LSL3-230/50/99	3
2400	LSL3-240/30/99	LSL3-240/40/99	LSL3-240/50/99	3
2500	LSL3-250/30/99	LSL3-250/40/99	LSL3-250/50/99	4
2600	LSL3-260/30/99	LSL3-260/40/99	LSL3-260/50/99	4
2700	LSL3-270/30/99	LSL3-270/40/99	LSL3-270/50/99	4
2800	LSL3-280/30/99	LSL3-280/40/99	LSL3-280/50/99	4
2900	LSL3-290/30/99	LSL3-290/40/99	LSL3-290/50/99	4

OPTIONAL FEATURES



Wall brackets 30 mm thick (2 pcs.)

Code: LSL-00.03

WALL SHELF FOR EQUIPMENT SINGLE



STANDARD FEATURES

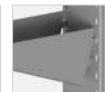

Easy to change height of the shelf

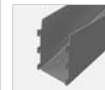

Heavy duty double bracket



Max loading 50 kg/shelf (uniform layout)

f Different dimensions and configurations are available on request. Examples on page 4.50.

Length L, mm	Width B, mm			Brackets
	300	400	500	
	Model	Model	Model	
400	LSI-40/30/33	LSI-40/40/33	LSI-40/50/33	2
500	LSI-50/30/33	LSI-50/40/33	LSI-50/50/33	2
600	LSI-60/30/33	LSI-60/40/33	LSI-60/50/33	2
700	LSI-70/30/33	LSI-70/40/33	LSI-70/50/33	2
800	LSI-80/30/33	LSI-80/40/33	LSI-80/50/33	2
900	LSI-90/30/33	LSI-90/40/33	LSI-90/50/33	2
1000	LSI-100/30/33	LSI-100/40/33	LSI-100/50/33	2
1100	LSI-110/30/33	LSI-110/40/33	LSI-110/50/33	2
1200	LSI-120/30/33	LSI-120/40/33	LSI-120/50/33	2
1300	LSI-130/30/33	LSI-130/40/33	LSI-130/50/33	2
1400	LSI-140/30/33	LSI-140/40/33	LSI-140/50/33	2
1500	LSI-150/30/33	LSI-150/40/33	LSI-150/50/33	2
1600	LSI-160/30/33	LSI-160/40/33	LSI-160/50/33	3
1700	LSI-170/30/33	LSI-170/40/33	LSI-170/50/33	3
1800	LSI-180/30/33	LSI-180/40/33	LSI-180/50/33	3
1900	LSI-190/30/33	LSI-190/40/33	LSI-190/50/33	3
2000	LSI-200/30/33	LSI-200/40/33	LSI-200/50/33	3
2100	LSI-210/30/33	LSI-210/40/33	LSI-210/50/33	3
2200	LSI-220/30/33	LSI-220/40/33	LSI-220/50/33	3
2300	LSI-230/30/33	LSI-230/40/33	LSI-230/50/33	3
2400	LSI-240/30/33	LSI-240/40/33	LSI-240/50/33	3
2500	LSI-250/30/33	LSI-250/40/33	LSI-250/50/33	4
2600	LSI-260/30/33	LSI-260/40/33	LSI-260/50/33	4
2700	LSI-270/30/33	LSI-270/40/33	LSI-270/50/33	4
2800	LSI-280/30/33	LSI-280/40/33	LSI-280/50/33	4
2900	LSI-290/30/33	LSI-290/40/33	LSI-290/50/33	4

OPTIONAL FEATURES



Wall brackets 30 mm thick (2 pcs.)

Code: LSI-00.03

WALL SHELF FOR EQUIPMENT DOUBLE

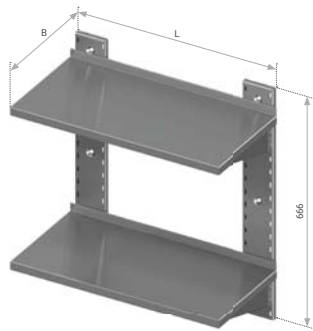

STANDARD FEATURES

EASY TO ASSEMBLE
(bracket thickness 13 mm)

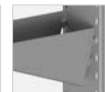
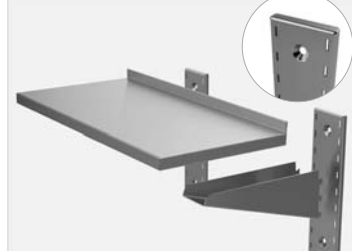

Easy to change height of the shelf

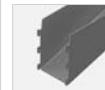

Heavy duty double bracket



Max loading 50 kg/shelf (uniform layout)

f Different dimensions and configurations are available on request. Examples on page 4.50.

Length L, mm	Width B, mm			Brackets
	300	400	500	
	Model	Model	Model	
400	LSI2-40/30/66	LSI2-40/40/66	LSI2-40/50/66	2
500	LSI2-50/30/66	LSI2-50/40/66	LSI2-50/50/66	2
600	LSI2-60/30/66	LSI2-60/40/66	LSI2-60/50/66	2
700	LSI2-70/30/66	LSI2-70/40/66	LSI2-70/50/66	2
800	LSI2-80/30/66	LSI2-80/40/66	LSI2-80/50/66	2
900	LSI2-90/30/66	LSI2-90/40/66	LSI2-90/50/66	2
1000	LSI2-100/30/66	LSI2-100/40/66	LSI2-100/50/66	2
1100	LSI2-110/30/66	LSI2-110/40/66	LSI2-110/50/66	2
1200	LSI2-120/30/66	LSI2-120/40/66	LSI2-120/50/66	2
1300	LSI2-130/30/66	LSI2-130/40/66	LSI2-130/50/66	2
1400	LSI2-140/30/66	LSI2-140/40/66	LSI2-140/50/66	2
1500	LSI2-150/30/66	LSI2-150/40/66	LSI2-150/50/66	2
1600	LSI2-160/30/66	LSI2-160/40/66	LSI2-160/50/66	3
1700	LSI2-170/30/66	LSI2-170/40/66	LSI2-170/50/66	3
1800	LSI2-180/30/66	LSI2-180/40/66	LSI2-180/50/66	3
1900	LSI2-190/30/66	LSI2-190/40/66	LSI2-190/50/66	3
2000	LSI2-200/30/66	LSI2-200/40/66	LSI2-200/50/66	3
2100	LSI2-210/30/66	LSI2-210/40/66	LSI2-210/50/66	3
2200	LSI2-220/30/66	LSI2-220/40/66	LSI2-220/50/66	3
2300	LSI2-230/30/66	LSI2-230/40/66	LSI2-230/50/66	3
2400	LSI2-240/30/66	LSI2-240/40/66	LSI2-240/50/66	3
2500	LSI2-250/30/66	LSI2-250/40/66	LSI2-250/50/66	4
2600	LSI2-260/30/66	LSI2-260/40/66	LSI2-260/50/66	4
2700	LSI2-270/30/66	LSI2-270/40/66	LSI2-270/50/66	4
2800	LSI2-280/30/66	LSI2-280/40/66	LSI2-280/50/66	4
2900	LSI2-290/30/66	LSI2-290/40/66	LSI2-290/50/66	4

OPTIONAL FEATURES



Wall brackets 30 mm thick (2 pcs.)

Code: LSI-00.03

WALL SHELF FOR EQUIPMENT TRIPLE



STANDARD FEATURES

EASY TO ASSEMBLE
(bracket thickness 13 mm)

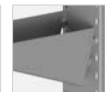
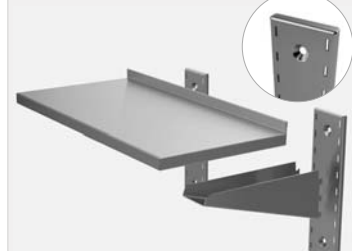

Easy to change height of the shelf



Heavy duty double bracket



Max loading 50 kg/shelf (uniform layout)

f Different dimensions and configurations are available on request. Examples on page 4.50.

Length L, mm	Width B, mm			Brackets
	300	400	500	
	Model	Model	Model	
400	LSI3-40/30/99	LSI3-40/40/99	LSI3-40/50/99	2
500	LSI3-50/30/99	LSI3-50/40/99	LSI3-50/50/99	2
600	LSI3-60/30/99	LSI3-60/40/99	LSI3-60/50/99	2
700	LSI3-70/30/99	LSI3-70/40/99	LSI3-70/50/99	2
800	LSI3-80/30/99	LSI3-80/40/99	LSI3-80/50/99	2
900	LSI3-90/30/99	LSI3-90/40/99	LSI3-90/50/99	2
1000	LSI3-100/30/99	LSI3-100/40/99	LSI3-100/50/99	2
1100	LSI3-110/30/99	LSI3-110/40/99	LSI3-110/50/99	2
1200	LSI3-120/30/99	LSI3-120/40/99	LSI3-120/50/99	2
1300	LSI3-130/30/99	LSI3-130/40/99	LSI3-130/50/99	2
1400	LSI3-140/30/99	LSI3-140/40/99	LSI3-140/50/99	2
1500	LSI3-150/30/99	LSI3-150/40/99	LSI3-150/50/99	2
1600	LSI3-160/30/99	LSI3-160/40/99	LSI3-160/50/99	3
1700	LSI3-170/30/99	LSI3-170/40/99	LSI3-170/50/99	3
1800	LSI3-180/30/99	LSI3-180/40/99	LSI3-180/50/99	3
1900	LSI3-190/30/99	LSI3-190/40/99	LSI3-190/50/99	3
2000	LSI3-200/30/99	LSI3-200/40/99	LSI3-200/50/99	3
2100	LSI3-210/30/99	LSI3-210/40/99	LSI3-210/50/99	3
2200	LSI3-220/30/99	LSI3-220/40/99	LSI3-220/50/99	3
2300	LSI3-230/30/99	LSI3-230/40/99	LSI3-230/50/99	3
2400	LSI3-240/30/99	LSI3-240/40/99	LSI3-240/50/99	3
2500	LSI3-250/30/99	LSI3-250/40/99	LSI3-250/50/99	4
2600	LSI3-260/30/99	LSI3-260/40/99	LSI3-260/50/99	4
2700	LSI3-270/30/99	LSI3-270/40/99	LSI3-270/50/99	4
2800	LSI3-280/30/99	LSI3-280/40/99	LSI3-280/50/99	4
2900	LSI3-290/30/99	LSI3-290/40/99	LSI3-290/50/99	4

OPTIONAL FEATURES



Wall brackets 30 mm thick (2 pcs.)

Code: LSI-00.03

DISH DRYING WALL SHELF DOUBLE

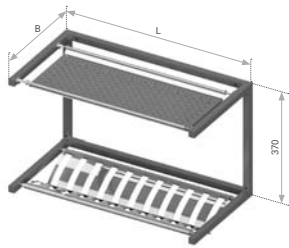

Different dimensions and configurations are available on request. Examples on page 4.50.

Length L, mm	Width B, mm		Quantity of plates	Max diameter of plates, mm
	330	Model		
610		LSD2-61/33/37	20	300
810		LSD2-81/33/37	28	300
1200		LSD2-120/33/37	40	300
1400		LSD2-140/33/37	48	300
1600		LSD2-160/33/37	56	300
1990		LSD2-199/33/37	68	300
2190		LSD2-219/33/37	76	300
2390		LSD2-239/33/37	84	300

STANDARD FEATURES



No sharp edges



Holders made of stainless steel tube 20 x 20 mm

DISH DRYING WALL SHELF DOUBLE WITH DRIP TRAY

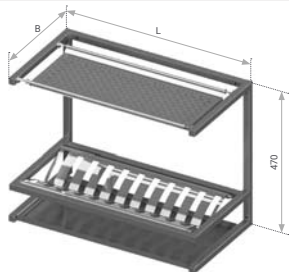

Different dimensions and configurations are available on request. Examples on page 4.50.

Length L, mm	Width B, mm		Quantity of plates	Max diameter of plates, mm
	330	Model		
610		LSD3-61/33/47	20	300
810		LSD3-81/33/47	28	300
1200		LSD3-120/33/47	40	300
1400		LSD3-140/33/47	48	300
1600		LSD3-160/33/47	56	300
1990		LSD3-199/33/47	68	300
2190		LSD3-219/33/47	76	300
2390		LSD3-239/33/47	84	300

STANDARD FEATURES

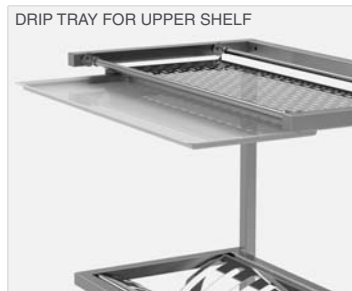

No sharp edges



Holders made of stainless steel tube 20 x 20 mm



Drip tray for lower shelf

SHELF FOR DISHWASHER BASKETS

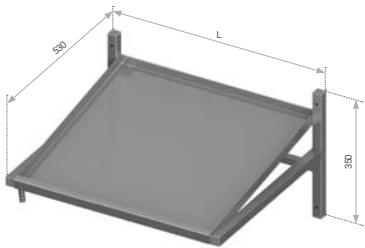

i Different dimensions and configurations are available on request. Examples on page 4.50.

Length L, mm	Width B, mm		Quantity of baskets	Dimensions of basket, mm
	S30	Model		
600	LSB1-60/53/35		1	500 x 500
1100	LSB1-110/53/35		2	500 x 500
1600	LSB1-160/53/35		3	500 x 500
2100	LSB1-210/53/35		4	500 x 500

DESIGNED FOR BASKETS
(500 x 500 mm)

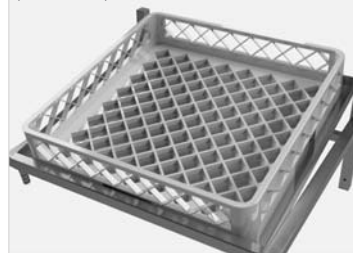

Water outlet (Ø 16 mm)

STANDARD FEATURES

OPTIONAL FEATURES



Water outlet on left or right side
Code: Y-SIV-K (left)
Y-SIV-D (right)

FOLDED WALL SHELF SINGLE

NEW

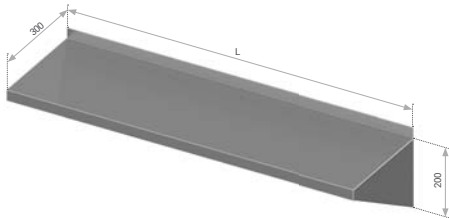

i Different dimensions and configurations are available on request. Examples on page 4.50.

Length L, mm	Width B, mm		Fittings
	S30	Model	
600	LSV1-60/30/20		2
700	LSV1-70/30/20		2
800	LSV1-80/30/20		2
900	LSV1-90/30/20		2
1000	LSV1-100/30/20		2

FOLDED SHELF CONSTRUCTION



Max loading 30 kg/shelf (uniform layout)

STANDARD FEATURES

WALL CABINET WITH SLIDING DOORS

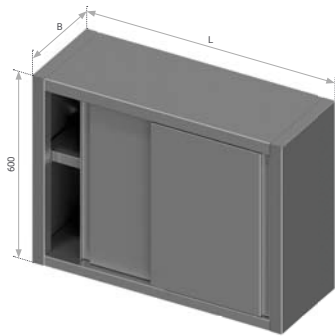

STANDARD FEATURES

TRIPLE LAYER SOUNDPROOF DOORS

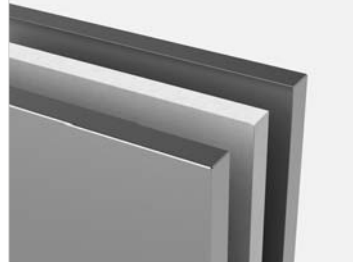

Easy to change height of the shelf



Wall fastener



Flat bottom design
Easy to clean flat shelf

f Different dimensions and configurations are available on request. Examples on page 4.50.

Length L, mm	Width B, mm		Doors
	300 Model	400 Model	
800	CKS2-80/30/60	CKS2-80/40/60	2
900	CKS2-90/30/60	CKS2-90/40/60	2
1000	CKS2-100/30/60	CKS2-100/40/60	2
1100	CKS2-110/30/60	CKS2-110/40/60	2
1200	CKS2-120/30/60	CKS2-120/40/60	2
1300	CKS2-130/30/60	CKS2-130/40/60	2
1400	CKS2-140/30/60	CKS2-140/40/60	2
1500	CKS2-150/30/60	CKS2-150/40/60	2
1600	CKS2-160/30/60	CKS2-160/40/60	2
1700	CKS2-170/30/60	CKS2-170/40/60	2
1800	CKS2-180/30/60	CKS2-180/40/60	2
1900	CKS2-190/30/60	CKS2-190/40/60	2
2000	CKS2-200/30/60	CKS2-200/40/60	2

OPTIONAL FEATURES



Lock
Code: A-CK-FUDS



Additional shelf
Code: A-C-LP

WALL CABINET WITH SHUTTING DOORS

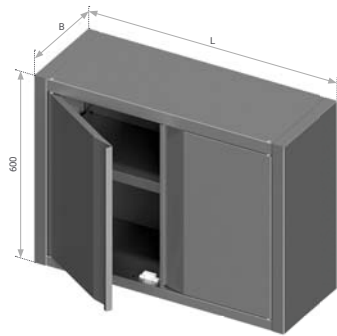

STANDARD FEATURES

TRIPLE LAYER SOUNDPROOF DOORS

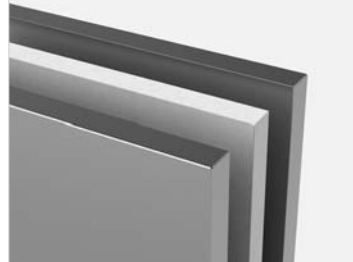

Easy to change height of the shelf



Wall fastener



Flat bottom design
Easy to clean flat shelf

f Different dimensions and configurations are available on request. Examples on page 4.50.

Length L, mm	Width B, mm		Doors
	300 Model	400 Model	
600	CKV2-60/30/60	CKV2-60/40/60	1
700	CKV2-70/30/60	CKV2-70/40/60	1
800	CKV2-80/30/60	CKV2-80/40/60	2
900	CKV2-90/30/60	CKV2-90/40/60	2
1000	CKV2-100/30/60	CKV2-100/40/60	2
1100	CKV2-110/30/60	CKV2-110/40/60	2
1200	CKV2-120/30/60	CKV2-120/40/60	2
1300	CKV2-130/30/60	CKV2-130/40/60	2
1400	CKV2-140/30/60	CKV2-140/40/60	3
1500	CKV2-150/30/60	CKV2-150/40/60	3
1600	CKV2-160/30/60	CKV2-160/40/60	3
1700	CKV2-170/30/60	CKV2-170/40/60	3
1800	CKV2-180/30/60	CKV2-180/40/60	3
1900	CKV2-190/30/60	CKV2-190/40/60	3
2000	CKV2-200/30/60	CKV2-200/40/60	4

OPTIONAL FEATURES



Lock
Code: A-C-FUDV



Additional shelf
Code: A-C-LP

CUPBOARD WITH SLIDING DOORS

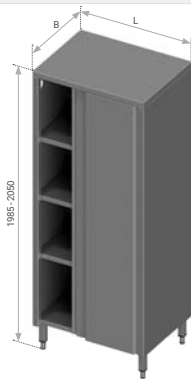

f Different dimensions and configurations are available on request. Examples on page 4.50.

Length L, mm	Width B, mm		Doors	Shelves
	600 Model	700 Model		
800	CPS4-80/60/200	CPS4-80/70/200	2	4
900	CPS4-90/60/200	CPS4-90/70/200	2	4
1000	CPS4-100/60/200	CPS4-100/70/200	2	4
1100	CPS4-110/60/200	CPS4-110/70/200	2	4
1200	CPS4-120/60/200	CPS4-120/70/200	2	4
1300	CPS4-130/60/200	CPS4-130/70/200	2	4
1400	CPS4-140/60/200	CPS4-140/70/200	2	4
1500	CPS4-150/60/200	CPS4-150/70/200	2	4
1600	CPS4-160/60/200	CPS4-160/70/200	2	4
1700	CPS4-170/60/200	CPS4-170/70/200	2	4

TRIPLE LAYER SOUNDPROOF DOORS

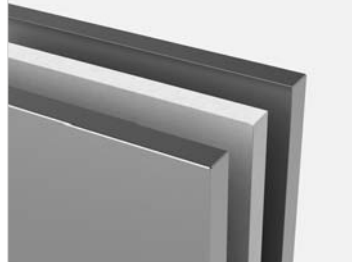

STANDARD FEATURES

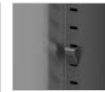

Easy to change height of the shelf



Integrated hygienic door handles



Adjustable stainless steel feet
(amplitude 65 mm +50/-15)

OPTIONAL FEATURES



Lock
Code: A-CP-FUDS



Additional shelf
Code: A-C-LP

CUPBOARD WITH SHUTTING DOORS



f Different dimensions and configurations are available on request. Examples on page 4.50.

Length L, mm	Width B, mm		Doors	Shelves
	600	700		
500	CPV4-50/60/200	CPV4-50/70/200	1	4
600	CPV4-60/60/200	CPV4-60/70/200	1	4
700	CPV4-70/60/200	CPV4-70/70/200	1	4
800	CPV4-80/60/200	CPV4-80/70/200	2	4
900	CPV4-90/60/200	CPV4-90/70/200	2	4
1000	CPV4-100/60/200	CPV4-100/70/200	2	4
1100	CPV4-110/60/200	CPV4-110/70/200	2	4
1200	CPV4-120/60/200	CPV4-120/70/200	2	4

TRIPLE LAYER SOUNDPROOF DOORS

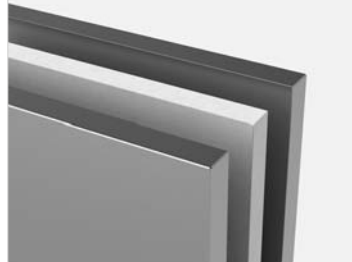

STANDARD FEATURES



Easy to change height of the shelf



Integrated hygienic door handles



Adjustable stainless steel feet
(amplitude 65 mm +50/-15)

OPTIONAL FEATURES



Lock
Code: A-CP-FUDA



Additional shelf
Code: A-C-LP

CUPBOARD FOR CLEANING EQUIPMENT



i Different dimensions and configurations are available on request. Examples on page 4.50.

Length L, mm	Width B, mm		Doors
	400 Model	500 Model	
800	CCV4-80/40/200	CCV4-80/50/200	2
1000	CCV4-100/40/200	CCV4-100/50/200	2

TRIPLE LAYER SOUNDPROOF DOORS

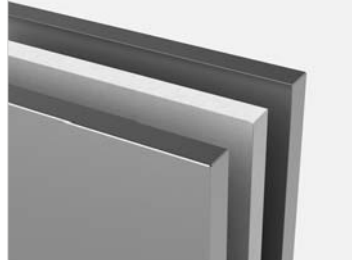

STANDARD FEATURES



Easy to change height of the shelf



Integrated hygienic door handles



Adjustable stainless steel feet
(amplitude 65 mm \pm 50/-15)

OPTIONAL FEATURES



Lock
Code: A-CP-FUDA



Additional shelf
Code: A-C-LP

☐ SPARE PARTS FOR LSL MODELS

📄 NOTES

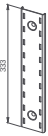

Wall bracket 10 mm thick (for LSL1)
Code: LSL-00.01



Wall bracket 10 mm thick (for LSL3)
Code: LSL-00.01



Wall bracket 10 mm thick (for LSL2)
Code: LSL-00.01

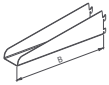

Under shelf bracket
Code: LSL-00.02

TERMS AND CONDITIONS



NOVAMETA STANDARD TERMS

Applicability

These Standard Terms ("Terms") apply to all products supplied directly by Novameta to its distributors.

Validity of quotations

Quotations are valid for 90 days unless otherwise explicitly stated in the individual quotation. Not responsible for misprints.

Delivery terms

Provided in the proforma invoice.
In case of ex-works (INCOTERMS 2010) Novameta shall not be liable for delays and the distributor shall not be permitted to terminate the purchase due to delays unless agreed to in writing.

Payment terms

Provided in the proforma invoice.
If a higher credit limit is necessary, security is mandatory. Novameta may reduce a credit limit at any time if considered appropriate by Novameta.

Storage terms

Provided in the proforma invoice.

Retention of Title

Novameta shall retain title in all products and components sold to the distributor until the distributor has paid for the products in full (including transportation and packaging costs).

Warranty terms

Novameta provides a Manufacturer's warranty for all of the equipment against defects in materials and workmanship for a period of 1 year from the date of invoicing of the defective product or component to the distributor. Manufacturer undertakes to replace all inferior parts to proper quality parts or materials. In case of a fault, a properly filled claim is required and must contain all essential information relative to the fault. Faulty parts shall be returned to Manufacturer for further inspection.

Extended warranty

The extended warranty is solely applicable to certain equipment (indicated in the price list). The extended warranty costs extra of the item's list price. Standard warranty terms apply.

Warranty exclusions and limitations of liability

The warranty in these Terms shall be the distributor's exclusive remedy for defective products and components towards Novameta. Novameta shall not be liable for any costs, expenses, losses or claims (whether direct, indirect, consequential or otherwise) relating to defective products or components unless otherwise explicitly stated herein or agreed in writing. Any expenses in connection with the installation or costs of making adjustments (including service procedures, travel time costs) on the equipment to comply with the supply at the point of installation are not covered by this warranty.
The producer does not take any responsibility for damages that occur due to ignorance of cautions, improper maintenance or mechanical damages of the unit, including those, caused during the delivery. This warranty is not effective if damage occurs from improper installation, misuse, incorrect voltage supply, wear and tear from normal usage, accidental breakage, damage or if the equipment is operated contrary to the user instructions. The warranty does not cover if the damage occurs due to natural disasters, fire, if repair service was made by unauthorized person.
In case of a failure not covered by the warranty, we provide a possibility to purchase spare parts.

NOVAMETA STANDARD TERMS

Procedure for repair or replacement under the warranty

The distributor shall, at its own costs, make all reasonable attempts to repair any defective component or product.

If such repair is not possible for the distributor, the distributor shall contact Novameta in writing immediately (within 3 working days) upon suspicion of any defects that may be covered by the warranty. If Novameta is not contacted immediately (within 3 working days) in such cases, the distributor shall have no remedies.
Distributor's contact shall include specific information as to the suspected defect the relevant order number and a copy of the relevant invoice.

After timely receipt of the above, Novameta will decide if there is a defect, whether the claim is covered by the warranty, and whether the product or component is to be replaced.

In cases where Novameta decides to replace defective products or components with new ones, the distributor will be billed the full amount for the goods when they are sent. This amount will then be credited when the defective product or components is returned to Novameta and it is established that the defective product or component is covered by the warranty.
With regard to the transport of products and components, Novameta will pay the freight of new or repaired products and components, while the distributor will pay the freight for defective goods that are returned (and any other costs related to the return of the goods). The warranty does not cover expenses of the service procedures performed. Novameta does not provide service.

Unless otherwise agreed in writing, the defective product or component should always be returned to Novameta: Draugystės g. 15D, LT-51227 Kaunas, Lithuania.

Cancellations

If an order cancellation request is made after confirmation of drawing and proforma invoice, adjustments are not possible and production cannot be stopped. In case of cancellation product will be charged in full.

Shipping and packing

Novameta will pack products for shipment in Novameta standard packaging. If the distributor has other requirements as to packing, the distributor shall contact Novameta to make special arrangements.

Delivery recommendations

Upon receipt, inspect units immediately for any shipping damage and notify carrier immediately if damage is found. It must be reported immediately (upon delivery) in writing in the CMR. Otherwise neither the Manufacturer nor the carrier can take responsibility for transport damage. All items are thoroughly inspected and carefully packed before leaving our factory, thus Novameta cannot accept responsibility for any shipping damage, however Novameta will assist in filing a claim.

Liability and Product liability

Novameta shall only be liable for defects and product liability to the extent set out herein (see particularly warranty terms). In addition to the aforesaid all liability is capped at the invoiced price of the defective product. All other liability is hereby excluded.

Choice of law and Venue

These Terms and the cooperation between Novameta and its distributors, including any disputes relating thereto, shall be governed by Lithuanian law.
Any disputes shall be settled before the Lithuanian courts, which shall have exclusive jurisdiction.

Company No. 235886490, VAT Reg. No. LT 358864917
Reg. No. 048959, Centre of Registers
IBAN: LT227300010071982293, Swedbank, AB

REFERENCES AND EXAMPLES OF CUSTOMISED EQUIPMENT



REFERENCES

COMPANY CANTEENS

- Booking.com Headquarters*
Amsterdam, Netherlands
- Novo Nordisk Pharmaceutical Company*
Bagsvaerd, Denmark
- Google Office*
Copenhagen, Denmark
- Michael Kors Distribution Centre*
Venlo, Netherlands
- Samsung Electronics Benelux Office*
Amsterdam, Netherlands
- Nordea Bank Headquarters*
Oslo, Norway
- ING Bank Office*
Amsterdam, Netherlands
- Rabobank Bank*
Eindhoven, Netherlands
- KLM Catering Services Office*
Amsterdam, Netherlands



ZD16-1185



ZU14-4014

EDUCATIONAL INSTITUTIONS

- University of Wolverhampton*
Wolverhampton, United Kingdom
- Copenhagen International School*
Copenhagen, Denmark
- Farmen Barnehage Kindergarten*
Levanger, Norway

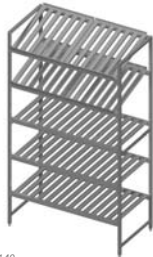

ZA16-4140

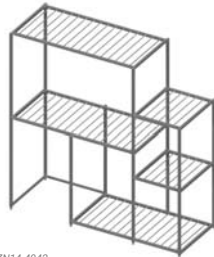

ZN14-4042

HOTELS

- Ramada Resort Hadera Beach Hotel*
Hadera, Israel
- Hilton Slussen Hotel*
Stockholm, Sweden
- Kempinski Hotel Cathedral Square*
Vilnius, Lithuania
- Thon Hotel Chain*
Norway
- Tallink City Hotel*
Tallinn, Estonia
- LEISURE AND LARGE VENUES*
- Royal Theatre Carré*
Amsterdam, Netherlands
- LEGOLAND Amusement Park*
Billund, Denmark
- The Well Spa Centre*
Oslo, Norway



ZF15-4004



ZD16-4029



ZA16-4020



ZE17-4020



Z014-4016



ZW15-4006



ZE17-4003



ZD17-1018

REFERENCES

RESTAURANTS AND BARS

- TGI Fridays Bar & Restaurant*
Sweden
- Chateau Motel Nightclub*
Copenhagen, Denmark
- Happy Italy Restaurants*
Netherlands
- Milu Bar & Restaurant*
The Hague, Netherlands
- Easy Wine Bar*
Riga, Latvia
- Flammen Restaurants*
Denmark
- Bierhuis Restaurant*
Uppsala, Sweden
- Hotcha Restaurant*
Liverpool, United Kingdom

GOVERNMENT & PUBLIC SERVICES

- Ministry of Economic Affairs*
The Hague, Netherlands
- Embassy of Hungary*
Stockholm, Sweden
- Statsfængslet Nordfalster Prison*
Nordtalster, Denmark

HEALTHCARE

- Mare Klinikum Medical Diagnostic Centre*
Kiel, Germany
- Wexham Park Hospital*
Slough, United Kingdom
- Zaans Medical Centre*
Zaandam, Netherlands
- Rikshospitalet Hospital*
Oslo, Norway
- Syrenparken Psychiatric Hospital*
Birkop, Denmark

SHOPS AND SUPERMARKETS

- ICA Supermarkets*
Sweden
- IKEA Stores*
Netherlands, Lithuania
- Coop Supermarkets*
Norway
- Hema Supermarkets*
Netherlands



DISHWASHING EQUIPMENT

Wide range of inlet and outlet tables to dishwasher and various customised solutions for sorting lines

PROFESSIONAL KITCHEN WORKTABLES

Huge variety of standard and customised worktables for creating an ergonomic and functional workspace for every chef

EXHAUST HOODS

Many different configurations of highly efficient hoods featuring cutting-edge technologies of cyclonic filtration, induction jets and laminar flow air supply

SHELVES AND CUPBOARDS

Numerous types of wall and upper shelves, wall cabinets, cupboards and shelving systems

TROLLEYS

More than 60 types of standard trolleys as well as many more customised variations

COOLING COUNTERS AND HEATED EQUIPMENT

More than 1000 models of standard cooling counters, different heated cupboards and upper shelves

BAR EQUIPMENT

Unlimited flexibility in unique coffee-station and bar solutions

OTHER TABLES AND STANDS

Different stands for all kinds of equipment, hand-wash basins and bakery or food processing tables with cutting boards

SERVING LINE EQUIPMENT

Various types of heating and cooling drop-in units, dispensers and shelving together with robust and elegant buffets and counters