



2018



COOLING TECHNIQUE CATALOGUE

373 81 Kamenný Újezd
Zemědělská 500, Czechia
sales@gastro.cz

GASTRO PRODUCTION
www.gastro.cz

030101 - Showcase BK	3	0310 - Cooling box for dustbins	34
030102 - Showcase PB	4		
030103 - Showcase KE	5		
030104 - Showcase BB	7		
030105 - Showcase VE	8		
030106 - Showcase Hangee	9		
030107 - Showcase MT	10		
030108 - Showcase Sugar	11		
030109 - Showcase Circuma	12		
0302 - Cooling box for KEGS	13		
0303 - Cooling plates	14		
0304 - Cooling tubs ventilated	15		
0305 - Cooling tubs static	17		
030601 - Beverage cooling table	18		
030602 - Cooling table GN	20		
030603 - Lowered cooling table GN	23		
030701 - Freezing table GN	27		
030702 - Lowered freezing table GN	30		
0308 - Extensions build in	32		
0309 - Extensions build on top	33		

Renders & Drawings



Configuration Table

Customer side	Service side	Cooling system	LED	Tub	Lock	Plinth	Painting	Length	Width	Height
GL Tilting glass	GL Tilting glass	A Aggregate	Y With LED	T With tub	L With lock	10 100mm	R RAL	0800	0700	1250
CP Clapper doors	CP Clapper doors	C Central cooling	X Without	X Without	X Without lock	15 150mm	B Brass	1000		
SD Sliding doors	SD Sliding doors					16 160mm	X Without	1200		
OP Opened	OP Opened					17 170mm		1400		
CL Closed	CL Closed					XX 0mm		1600		

Configuration Example

Standard configuration example.
030101-CPSDA-1200x0700x1250

- 030101 - Baker Hansen showcase
- CP - Customer side: Clapper doors
- SD - Service side: Sliding door
- A - Cooling system: Aggregate
- 1200x0700x1250 - Dimension (length x width x height)

Tilting glass

€ xxx



Sliding doors

€ xxx

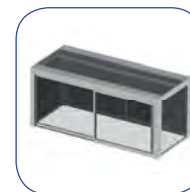

Clappers

€ xxx



Showcase BK

CODE	LENGTH	WIDTH	HEIGHT	PRICE
030101-CPSDA-0800	0800	0700	1250	
030101-CPSDA-1000	1000	0700	1250	
030101-CPSDA-1200	1200	0700	1250	
030101-CPSDA-1400	1400	0700	1250	
030101-CPSDA-1600	1600	0700	1250	

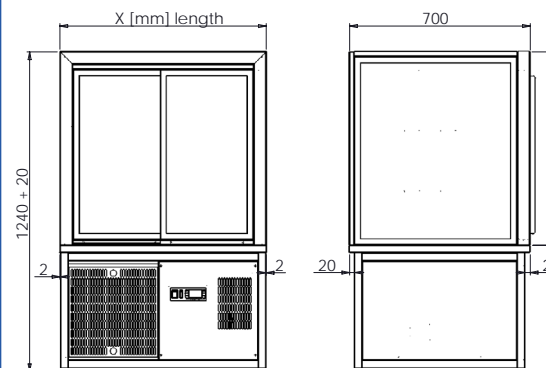

Renders & Drawings



Configuration Table

Type	Shelves	Design	Cooling system	LED	Lock	Plinth	Painting	Length	Height
N	Normal	SL Sloping OP Opened	A Aggregate	Y With LED	L With lock	10 100mm	R RAL	0800	1600
L	Little	ST Straight HD With doors	V Central cooling	X Without	X Without	15 150mm	B Brass	1000	2025
		SL With sliding doors				16 160mm	X None	1200	
						17 170mm		1400	
						XX 0mm		1600	
								1800	

Configuration Example

Standard configuration example.
030102-NSLOPA-1200

- 030102 - PB showcase
- SL - Shelves: Sloping
- OP - Design: Opened
- A - Cooling system: Aggregate
- 1200 - Length: 1200mm

Showcase Little PB

CODE	LENGTH	WIDTH	HEIGHT	PRICE
030102-LSTOPA-0800	0800	0730	1600	
030102-LSTOPA-1000	1000	0730	1600	
030102-LSTOPA-1200	1200	0730	1600	
030102-LSTOPA-1400	1400	0730	1600	
030102-LSTOPA-1600	1600	0730	1600	
030102-LSTOPA-1800	1800	0730	1600	

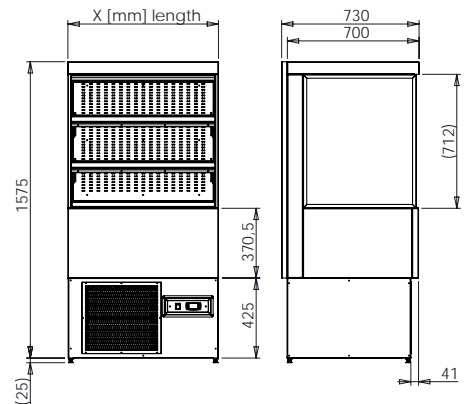

Showcase PB

CODE	LENGTH	WIDTH	HEIGHT	PRICE
030102-NSTOPA-0800	0800	0730	2025	
030102-NSTOPA-1000	1000	0730	2025	
030102-NSTOPA-1200	1200	0730	2025	
030102-NSTOPA-1400	1400	0730	2025	
030102-NSTOPA-1600	1600	0730	2025	
030102-NSTOPA-1800	1800	0730	2025	

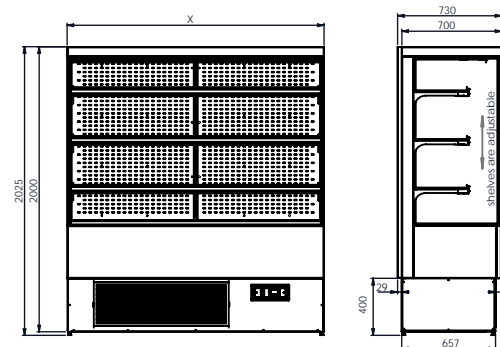

Renders & Drawings



Tilting glass

€ xxx



Sliding doors

€ xxx



Clapper doors

€ xxx



Configuration Example

Standard configuration example.

030103-2D1C2CPSD0-1200x0750x1660

- 030103 - Showcase KE
- 2 - Cooling table 2GN
- D1 - 1.GN: 100 + 150
- C2 - 2.GN: 2x Doors + Sliders
- CP - Customer side: Clapper doors
- SD - Customer side: Sliding doors
- A - Cooling system: Aggregate
- 1200x0750x1660 - Dimension (length x width x height)

Configuration Table

Cooling table	1.GN	2.GN	3.GN	Customer side	Service side	Cooling system	LED	Lock	Plinth	Painting	Length	Width	Height
1 Cooling table 1GN	D1 100 + 150	D1 100 + 150	D1 100 + 150	CP Clapper doors	CP Clapper doors	A Aggregate	Y With LED	L With lock	10 100mm	R RAL	0800	0700	1660
2 Cooling table 2GN	C1 1x Door + Sliders	C1 1x Door + Sliders	C1 1x Door + Sliders	FG Fixed glass	FG Fixed glass	C Central Cooling	X Without	X Without	15 150mm	B Brass	1200	0750	
3 Cooling table 3GN	C2 2x Doors + Sliders	C2 2x Doors + Sliders	C2 2x Doors + Sliders	GL Tilting doors	GL Tipping doors				16 160mm	X No decor.	1600		
		XX Nothing	XX Nothing	SD Sliding doors	SD Sliding doors				17 170mm		2000		
				OP Opened	OP Opened				XX XX				
				CL Closed	CL Closed								

Showcase KE

CODE	GN	LENGTH	WIDTH	HEIGHT	PRICE
030103-1C1XXXXSDSDA-0800x0700	1GN	0800	0700	1660	
030103-1C1XXXXSDSDA-0800x0750	1GN	0800	0750	1660	
030103-2C1C1XXSDSDA-1200x0700	2GN	1200	0700	1660	
030103-2C1C1XXSDSDA-1200x0750	2GN	1200	0750	1660	
030103-3C1C1C1SDSDA-1600x0700	3GN	1600	0700	1660	
030103-3C1C1C1SDSDA-1600x0750	3GN	1600	0750	1660	

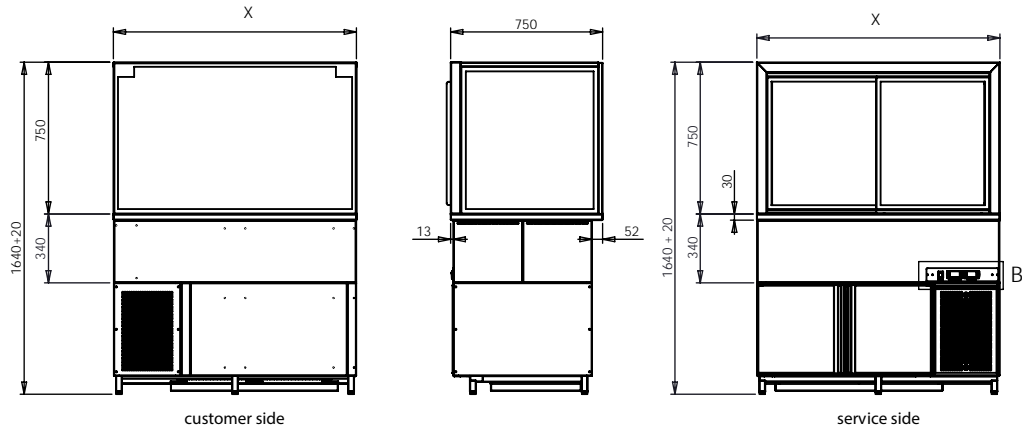

DETAIL B

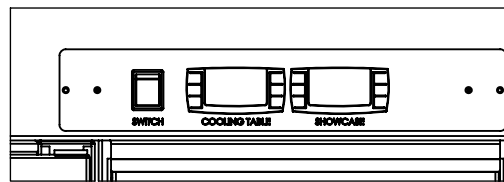

Renders & Drawings



Configuration Example

Standard configuration example.
030104-D2GNCPDA

- 030104 - Showcase BB
- D - Type: On the desk
- 2GN - GN: 2GN
- CP - Customer side: Clapper doors
- SD - Service side: Sliding doors
- A - Cooling system: Aggregate

Configuration Table

Type	GN		Customer side	Service side	Cooling system	LED	Lock	Plinth	Painting	Length		Width		Height	
D On the desk	1GN	1GN	FG Fixed glass	SD Sliding doors	A Aggregate	Y With LED	L Lock	10 100mm	R RAL	0800	800mm	0600	600mm	0910	910mm
F On the frame	2GN	2GN	CP Clapper doors	ND Normal doors	C Central co.	X Without	X None	15 150mm	B Brass	1000	1000mm	0650	650mm		
	3GN	3GN	SD Sliding doors	CL Closed				16 160mm	X No decor.	1200	1200mm	0700	700mm		
	4GN	4GN	CL Closed	FG Fixed glass				17 170mm		1400	1400mm	XXXX	acc to GN		
	5GN	5GN						XX 0mm		1600	1600mm				
	6GN	6GN								1800	1800mm				
	AAA	Atypical								XXXX	acc to GN				

Showcase BB

CODE	LENGTH	WIDTH	HEIGHT	PRICE
030104-D1GNCPDA	0475	0700	0810	
030104-D2GNCPDA	0775	0700	0910	
030104-D3GNCPDA	1138	0700	0910	
030104-D4GNCPDA	1500	0700	0910	
030104-D5GNCPDA	1863	0700	0910	
030104-D6GNCPDA	2225	0700	0910	

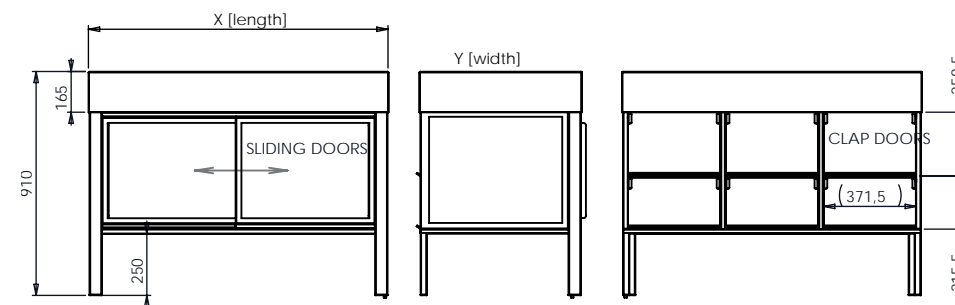

Renders & Drawings



Showcase VE

CODE	LENGTH	WIDTH	HEIGHT	PRICE
030105-DA-0800	0800	0700	1475	
030105-DA-1200	1200	0700	1475	
030105-DA-1600	1600	0700	1475	
030105-FA-0800	0800	0700	1475	
030105-FA-1200	1200	0700	1475	
030105-FA-1600	1600	0700	1475	

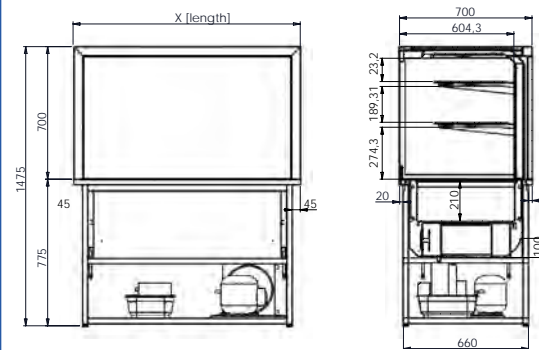

Configuration Table

Type	Cooling system	LED	Lock	Plinth	Painting	Length
D On the desk	A Aggregate	Y With LED	L With Lock	10 100mm	R RAL	0800
F On the frame	C Central Cooling	X Without	X Without lock	15 150mm	B Brass	1200
				16 160mm	X No decoration	1600
				17 170mm		
				XX 0mm		

Configuration Example

Standard configuration example.
030105-FA-1200

- 030105 - Showcase VE
- F - Type: On the frame
- A - Cooling system: Aggregate
- 1200 - Length: 1200

Renders & Drawings



Configuration Table

Front side		Back side		Cooling system		LED		Lock		Painting		Length	Width	Height
SL	Sliding door	SL	Sliding doors	A	Aggregate	Y	With LED	L	Lock	R	RAL	0800	0600	1400
		FG	Fixed glass	C	Central cooling	X	Without	X	Without	B	Brass	1200		1500
		SS	Steel sheet							X	No decoration	1600		1600

Configuration Example

Standard configuration example.
030106-A-0800x0600x1600

- 030106 - Showcase Hangee
- A - Type: Cooling by aggregate
- 0800 - Length: 0800
- 0600 - Width: 0600
- 1600 - Height: 1600

Showcase Hangee

CODE	LENGTH	WIDTH	HEIGHT		
			Z=1400	Z=1500	Z=1600
030106-SLSSA-0800x0600x[height]	0800	0600			
030106-SLSSA-1200x0600x[height]	1200	0600			
030106-SLSSA-1600x0600x[height]	1600	0600			
030106-SLSSC-0800x0600x[height]	0800	0600			
030106-SLSSC-1200x0600x[height]	1200	0600			
030106-SLSSC-1600x0600x[height]	1600	0600			

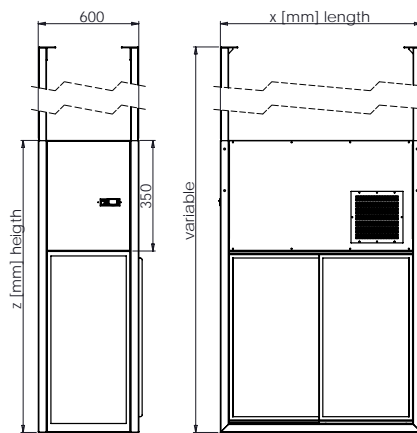

Renders & Drawings



Configuration Table

Customer side	Service side	Cooling system	LED	Lock	Plinth	Painting	Length
WD Wing doors	WD Wing doors	A Aggregate	Y With LED	L Lock	10 100mm	R RAL	0800
SD Sliding doors	SD Sliding doors	C Central cooling	X Without	X Without lock	15 150mm	B Brass	1000
CL Closed	CL Closed				16 160mm	X No decor.	1200
					17 170mm		1400
					XX 0mm		1600

Configuration Example

Standard configuration example.

030107-SDWDA-1000

030107 - Showcase MT
 SD - Customer side: Sliding doors
 WD - Service side: Wing doors
 A - Cooling system: Aggregate
 1000 - Length: 1000

Showcase MT

CODE	LENGTH	WIDTH	HEIGHT	PRICE
030107-WDCLA-0800	0800	0800	2400	
030107-WDCLA-1000	1000	0800	2400	
030107-WDCLA-1200	1200	0800	2400	
030107-WDCLA-1400	1400	0800	2400	
030107-WDCLA-1600	1600	0800	2400	

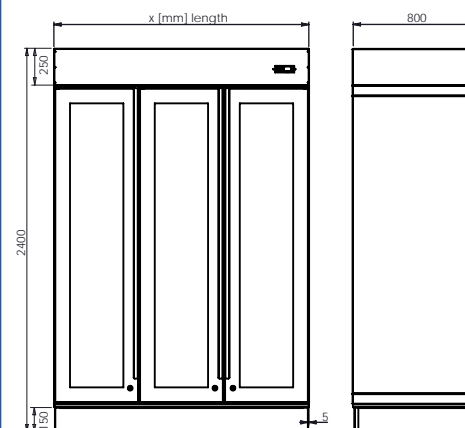

Renders & Drawings



Configuration Table

Cooling system	LED	Lock	Plinth	Painting	Length
A Aggregate	Y With LED	L With Lock	10 100mm	R RAL	0800
C Central Cooling	X Without	X Without	15 150mm	B Brass	1000
			16 160mm	X No decor.	1200
			17 170mm		1400
			XX 0mm		1600

Configuration Example

Standard configuration example.

030108-A-1600

- 030108 - Showcase Sugar
- A - Cooling system: Aggregate
- 1600 - Length: 1600

Showcase Sugar

CODE	LENGTH	WIDTH	HEIGHT	PRICE
030108-A-0800	0800	0700	2650	
030108-A-1000	1000	0700	2650	
030108-A-1200	1200	0700	2650	
030108-A-1400	1400	0700	2650	
030108-A-1600	1600	0700	2650	

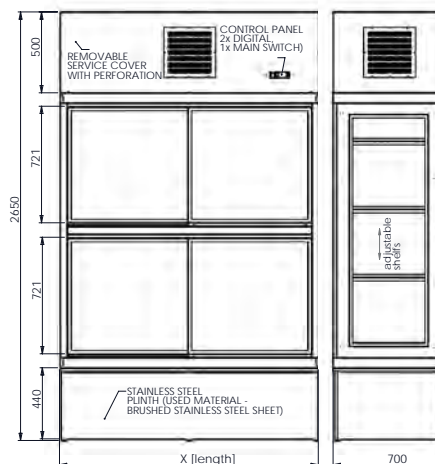

Renders & Drawings



Configuration Table

Cooling system	LED	Lock	Plinth	Painting	Diameter	Height
A Aggregate	Y With LED	L With Lock	10 100mm	R RAL	1600	0900
C Central Cooling	X Without	X Without	15 150mm	B Brass		
			16 160mm	X No decor.		
			17 170mm			
			XX 0mm			

Configuration Example

Standard configuration example.
030109-A-1600

030109 - Showcase Circuma

Showcase Circuma

CODE	DIAMETER	HEIGHT	PRICE
030109-A-1600x0900	1600	0900	

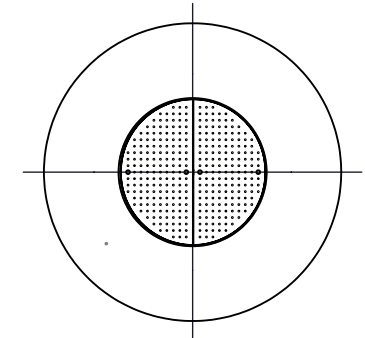
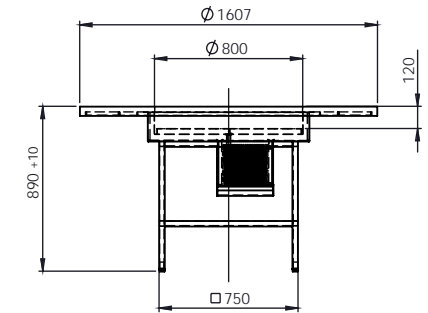

Renders & Drawings



Configuration Table

Type	
4KEG	4 Barrels
6KEG	6 Barrels
8KEG	8 Barrels

Configuration Example

Standard configuration example.
0302-6KEG

- 0302 - Cooling box for KEGS
- 6KEG - Type: 6KEG

Cooling box for KEGS

CODE	LENGTH	WIDTH	HEIGHT	KEGS	PRICE
0302-4KEG	1000	0993	0950	4	
0302-6KEG	1400	0993	0950	6	
0302-8KEG	1880	0993	0950	8	

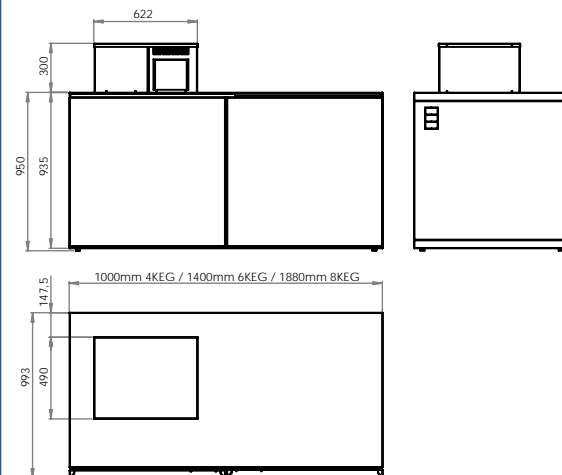

Renders & Drawings



Configuration Table

Cooling system	Type	Amount of GN
S Separate aggregate	DI Drop-ip	1GN 1
A Integrated aggregate	GL Glued	2GN 2
C Central cooling	UH Under-hang	3GN 3
		4GN 4
		5GN 5
		6GN 6
		AAA Atypical

Configuration Example

Standard configuration example.
0303-ADI3GN

- 0303 - Cooling plates
- A - Integrated aggregate
- DI - Type: Drop-in
- 3GN - Amount of GN: 3GN

Cooling plate drop-in without aggregate

CODE	LENGTH	WIDTH	HEIGHT	CUT OUT	PRICE
0303-CDI1GN	0365	0570	0048	345x550	
0303-CDI2GN	0690	0570	0048	670x550	
0303-CDI3GN	1015	0570	0048	995x550	
0303-CDI4GN	1340	0570	0048	1320x550	
0303-CDI5GN	1665	0570	0048	1645x550	
0303-CDI6GN	1990	0570	0048	1970x550	

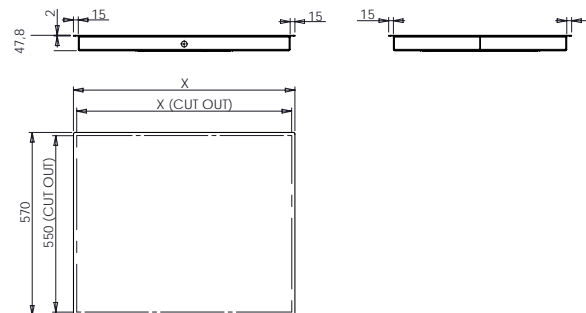

Cooling plate drop-in with aggregate

CODE	LENGTH	WIDTH	HEIGHT	CUT OUT	PRICE
0303-ADI1GN	0365	0570	0293	345x550	
0303-ADI2GN	0690	0570	0293	670x550	
0303-ADI3GN	1015	0570	0293	995x550	
0303-ADI4GN	1340	0570	0293	1320x550	
0303-ADI5GN	1665	0570	0293	1645x550	
0303-ADI6GN	1990	0570	0293	1970x550	

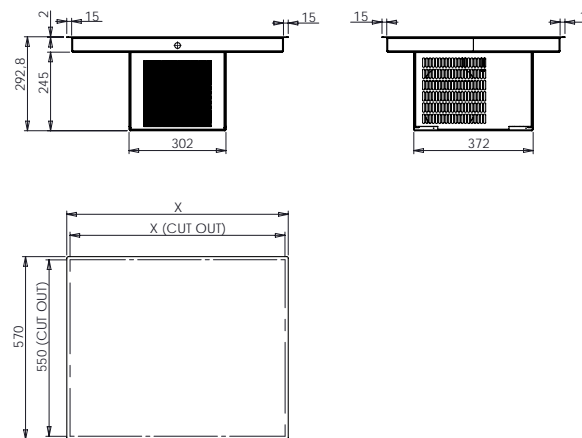

Renders & Drawings



Configuration Table

Type	Amount of GN	Plinth
DI Drop-in	2GN	10 100mm
UD Under the desk	3GN	15 150mm
WD Welded	4GN	16 160mm
	5GN	17 170mm
	6GN	XX No plinth

Configuration Example

Standard configuration example.
0304-DI3GN

- 0304 - Cooling tub ventilated
- DI - Type: Drop-in
- 3GN - Amount of GN: 3GN

Cooling tub ventilated - drop-in

CODE	LENGTH	WIDTH	HEIGHT	PRICE
0304-DI2GN	0765	0690	0900	
0304-DI3GN	1090	0690	0900	
0304-DI4GN	1415	0690	0900	
0304-DI5GN	1740	0690	0900	
0304-DI6GN	2065	0690	0900	

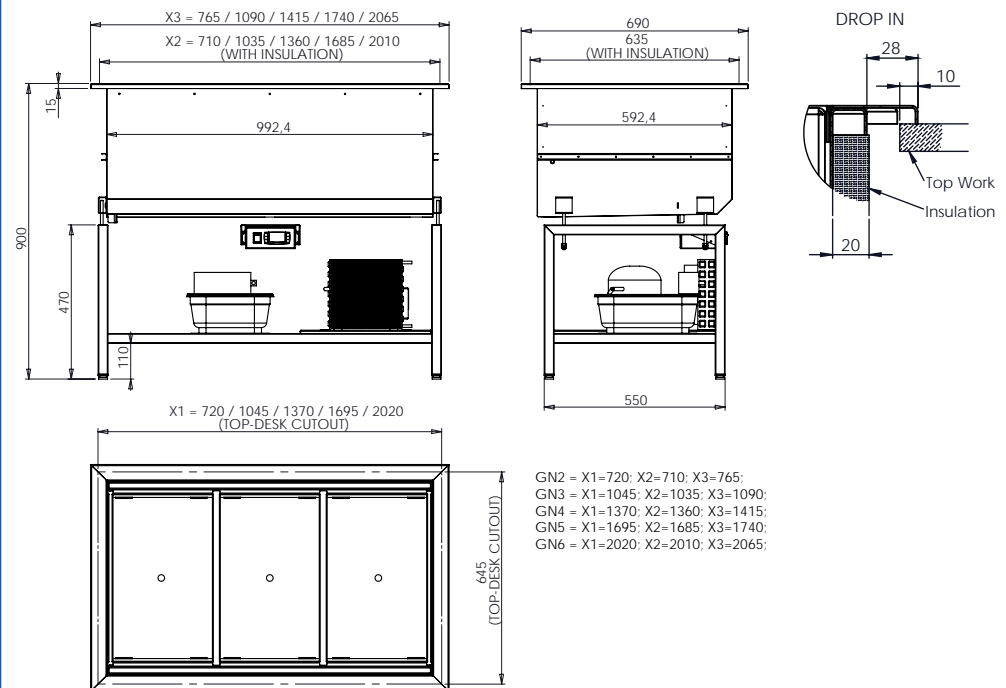

Cooling tub ventilated - under the desk

CODE	LENGTH	WIDTH	HEIGHT	PRICE
0304-UD2GN	0710	0635	0900	
0304-UD3GN	1035	0635	0900	
0304-UD4GN	1360	0635	0900	
0304-UD5GN	1685	0635	0900	
0304-UD6GN	2010	0635	0900	

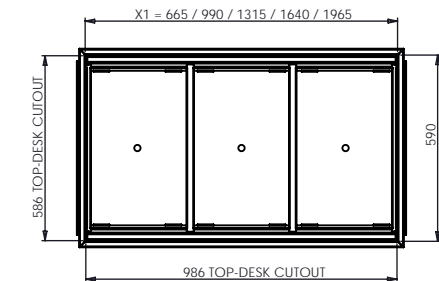
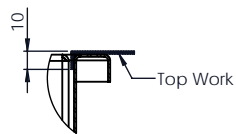
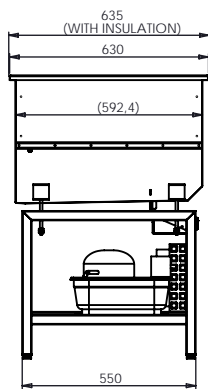
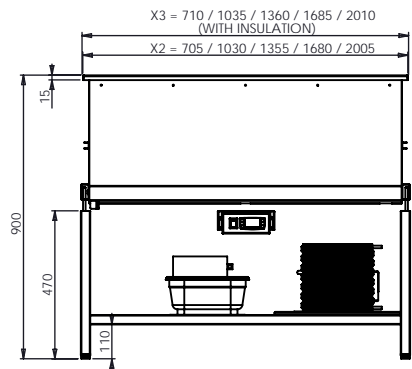

GN2 = X1=665, X2=705, X3=710;
 GN3 = X1=990, X2=1030, X3=1035;
 GN4 = X1=1315, X2=1355, X3=1360;
 GN5 = X1=1640, X2=1680, X3=1685;
 GN6 = X1=1965, X2=2005, X3=2010;

Renders & Drawings



Configuration Table

Montage		Aggregate		Amount of GN	Plinth	
DI	Drop-ip	UH	Underhung	2GN	10	100mm
WD	Welded	OU	Out of the tub	3GN	15	150mm
				4GN	16	160mm
				5GN	17	170mm
				6GN	XX	No plinth

Configuration Example

Standard configuration example.
0305-DIUH3GN

- 0305 - Cooling tub static
- DI - Type: Drop-in
- UH - Aggregate: Underhung
- 3GN - Amount of GN: 3GN

Cooling tub static

CODE	LENGTH	WIDTH	HEIGHT	PRICE
0305-DIUH1GN	0425	0630	0524	
0305-DIUH2GN	0750	0630	0524	
0305-DIUH3GN	1075	0630	0524	
0305-DIUH4GN	1400	0630	0524	
0305-DIUH5GN	1725	0630	0524	
0305-DIUH6GN	2050	0630	0524	

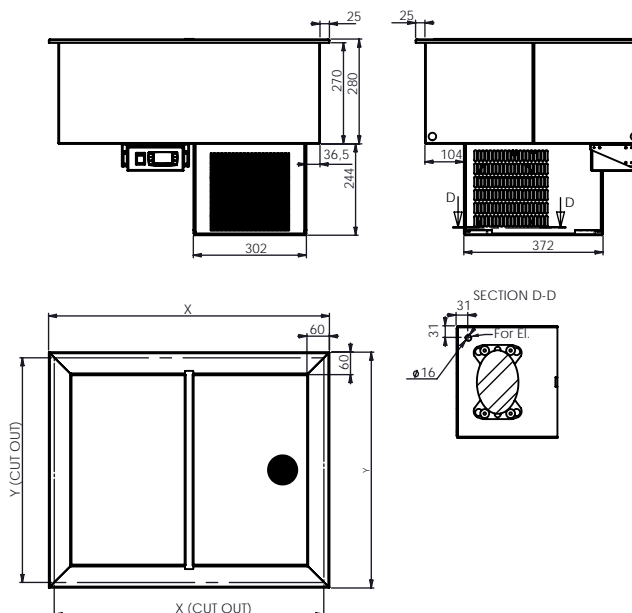

Renders & Drawings



Configuration Example

Standard configuration example.
030601-3D2C1D3XXSR

- 030601 - Beverage cooling table
- 3 - Type: 3 chambers
- D2 - 1. Chamber: 1/3+1/3+1/3
- C1 - 2. Chamber: Door
- D3 - 3. Chamber: 1/3+2/3
- * - The rest chambers: Nothing
- SR - Aggregate: Standard aggregate

Configuration Table

Type	1. Chamber	2. Chamber	3. Chamber	4. Chamber	Aggregate	Control panel	Legs	Lifting	Plinth	Waterproof Aggr. / C. panel
1 1 Chamber	D1 1/2+1/2	D1 1/2+1/2	D1 1/2+1/2	D1 1/2+1/2	SR Standard right	SR Standard right	R Rounded legs	Y Yes	10 100mm	W Waterproof
2 2 Chambers	D2 1/3+1/3+1/3	D2 1/3+1/3+1/3	D2 1/3+1/3+1/3	D2 1/3+1/3+1/3	MR Minimal right	MR Minimal right	J Square tube	X No	15 150mm	X No waterproof
3 3 Chambers	D3 1/3+2/3	D3 1/3+2/3	D3 1/3+2/3	D3 1/3+2/3	VL Cooling tub left	SL Standard left	X Without legs		16 160mm	
4 4 Chambers	D4 5/12+7/12	D4 5/12+7/12	D4 5/12+7/12	D4 5/12+7/12	VR Cooling tub right	ML Minimal left			17 170mm	
	D5 7/12+5/12	D5 7/12+5/12	D5 7/12+5/12	D5 7/12+5/12	XX Without agg.	XX Without contr.			XX Without	
	V1 Cooling tub	V1 Cooling tub	V1 Cooling tub	V1 Cooling tub	SL Standard left					
	C1 Doors	C1 Door	C1 Door	C1 Door	ML Minimal left					
	C2 2x Doors	C2 2x Doors	C2 2x Doors	C2 2x Doors						
		XX Nothing	XX Nothing	XX Nothing						

Drawers 1/2

€ xxx



Ladder

€ xxx



Glass door

€ xxx



Drawers 1/3

€ xxx



Door

€ xxx



Drawers 7/12 + 5/12

€ xxx



Grate shelf

€ xxx

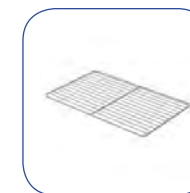

Drawers 5/12 + 7/12

€ xxx



Perforated shelf

€ xxx

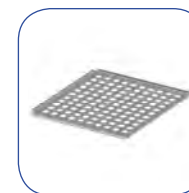

Technical drawings - Beverage cooling table

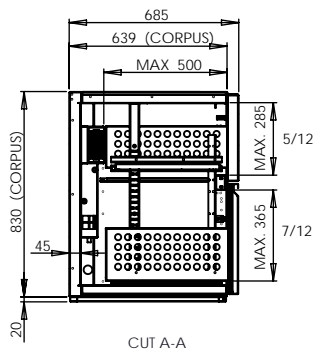
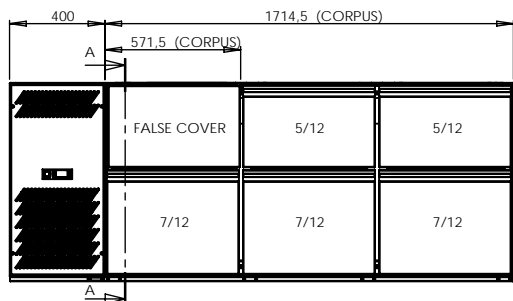

Chambers + Agg.	X	Y	Z
1 Chamber	0972	0685	830+20
2 Chambers	1543	0685	830+20
3 Chambers	2115	0685	830+20
4 Chambers	2686	0685	830+20

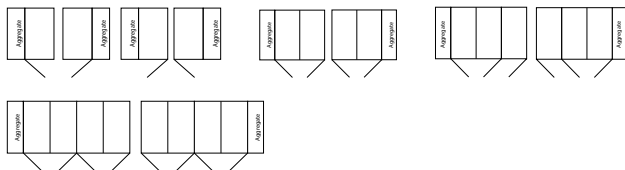

Beverage cooling table without aggregate and control panel

CODE	CHAMBERS	LENGTH	WIDTH	HEIGHT	PRICE
030601-1C1	1 chamber	0572	0685	830+20	
030601-2C1C1	2 chambers	1143	0685	830+20	
030601-3C1C1C1	3 chambers	1715	0685	830+20	
030601-4C1C1C1C1	4 chambers	2286	0685	830+20	



*Top plates are **not** included in standard configurations!
 ** Top plates are ordered separately in neutral equipment!

Beverage cooling table with aggregate

CODE	CHAMBERS	LENGTH	WIDTH	HEIGHT	PRICE
030601-1C1*SL	1 chamber	0972	0685	830+20	
030601-2C1C1*SL	2 chambers	1543	0685	830+20	
030601-3C1C1C1*SL	3 chambers	2115	0685	830+20	
030601-4C1C1C1C1SL	4 chambers	2686	0685	830+20	
030601-1C1*SR	1 chamber	0972	0685	830+20	
030601-2C1C1*SR	2 chambers	1543	0685	830+20	
030601-3C1C1C1*SR	3 chambers	2115	0685	830+20	
030601-4C1C1C1C1SR	4 chambers	2686	0685	830+20	



*Top plates are **not** included in standard configurations!
 ** Top plates are ordered separately in neutral equipment!

Beverage cooling table with control panel

CODE	CHAMBERS	LENGTH	WIDTH	HEIGHT	PRICE
030601-1C1*XXSL	1chamber	0972	0685	830+20	
030601-2C1C1*XXSL	2 chambers	1543	0685	830+20	
030601-3C1C1C1*XXSL	3 chambers	2115	0685	830+20	
030601-4C1C1C1C1XXSL	4 chambers	2686	0685	830+20	
030601-1C1*XXSR	1 chamber	0972	0685	830+20	
030601-2C1C1*XXSR	2 chambers	1543	0685	830+20	
030601-3C1C1C1*XXSR	3 chambers	2115	0685	830+20	
030601-4C1C1C1C1XXSR	4 chambers	2686	0685	830+20	



*Top plates are **not** included in standard configurations!
 ** Top plates are ordered separately in neutral equipment!

Renders & Drawings



Drawers 1/2
€ xxx



Drawers 1/3
€ xxx

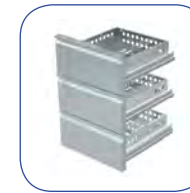

Door
€ xxx



Glass door
€ xxx



Grate shelf
€ xxx

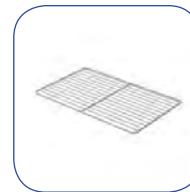

Perforated shelf
€ xxx

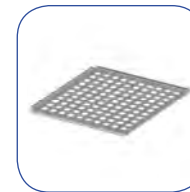

Ladder
€ xxx



Configuration Example

Standard configuration example.
030602-5D2C1D1C1C1SR

- 030602 - Cooling table GN
- 5 - Type: 5GN
- D2 - 1GN: 1/3+1/3+1/3
- C1 - 2GN: Door + sliders
- D1 - 3GN: 1/2+1/2
- C1 - 4GN: Door + sliders
- C1 - 5GN: Door + sliders
- SR - Aggregate: Standard aggregate

Configuration Table

Type	1. GN	2. GN	3. GN	4. GN	5. GN	Aggregate	Control panel	Legs	Lifting	Plinth	Waterproof Aggr. / C. panel
1	1GN D1 1/2+1/2	D1 1/2+1/2	D1 1/2+1/2	D1 1/2+1/2	D1 1/2+1/2	SR Standard right	SR Standard right	R Rounded legs	Y Yes	10 100mm	W Waterproof
2	2GN D2 1/3+1/3+1/3	D2 1/3+1/3+1/3	D2 1/3+1/3+1/3	D2 1/3+1/3+1/3	D2 1/3+1/3+1/3	MR Minimal right	MR Minimal right	J Square tube	X No	15 150mm	X Without
3	3GN C1 Door + sliders	C1 Door + sliders	C1 Door + sliders	C1 Door + sliders	C1 Door + sliders	SL Standard left	SL Standard left	X Without legs		16 160mm	
4	4GN C2 2x Doors + sliders	C2 2x Doors + sliders	C2 2x Doors + sliders	C2 2x Doors + sliders	C2 2x Doors + sliders	ML Minimal left	ML Minimal left			17 170mm	
5	5GN	XX Nothing	XX Nothing	XX Nothing	XX Nothing	VL Cooling tub left	XX Without contr.			XX Nothing	
						VR Cooling tub right					
						XX Without aggr.					

Technical drawings

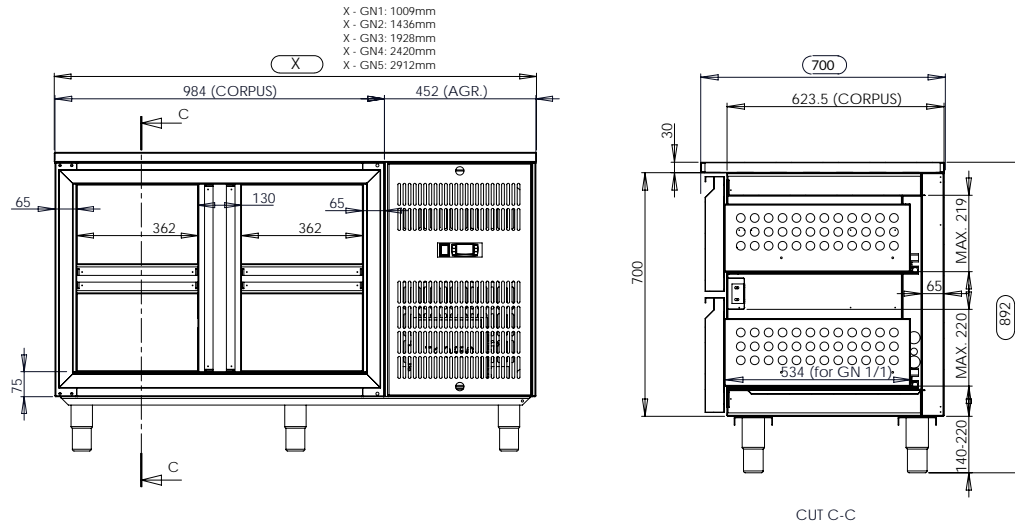

Doors and aggregate variations

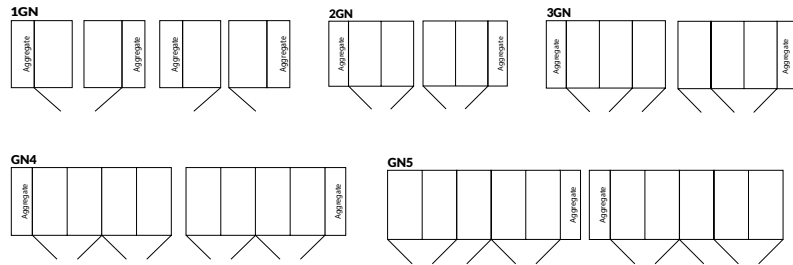

Types of control panels and aggregates

Aggregate MIN.
270 mm



Aggregate STANDARD
452 mm



Control panel MIN.
100 mm



Control panel STANDARD
180 mm



Cooling tables without aggregate and control panel

CODE	TYPE	LENGTH	WIDTH	HEIGHT	PRICE
030602-1C1	1GN	0557	0685	0700	
030602-2C1C1	2GN	0984	0685	0700	
030602-3C1C1C1	3GN	1476	0685	0700	
030602-4C1C1C1C1	4GN	1968	0685	0700	
030602-5C1C1C1C1C1	5GN	2460	0685	0700	



*Top plates are **not** included in standard configurations!
 ** Top plates are ordered separately in neutral equipment!

Lifting cooling table GN without aggregate and control panel

CODE	TYPE	LENGTH	WIDTH	HEIGHT	PRICE
030602-1C1*XXXXJY	1GN	0657	0685	0700+140-220	
030602-2C1C1*XXXXJY	2GN	1084	0685	0700+140-220	
030602-3C1C1C1*XXXXJY	3GN	1576	0685	0700+140-220	
030602-4C1C1C1C1*XXXXJY	4GN	2068	0685	0700+140-220	
030602-5C1C1C1C1C1*XXXXJY	5GN	2560	0685	0700+140-220	



*Top plates are **not** included in standard configurations!
 ** Top plates are ordered separately in neutral equipment!

Cooling tables GN

CODE	TYPE	LENGTH	WIDTH	HEIGHT	PRICE
030602-1C1*SR	1GN - Aggr. right	1009	0685	0700	
030602-2C1C1*SR	2GN - Aggr. right	1436	0685	0700	
030602-3C1C1C1*SR	3GN - Aggr. right	1928	0685	0700	
030602-4C1C1C1C1*SR	4GN - Aggr. right	2420	0685	0700	
030602-5C1C1C1C1C1SR	5GN - Aggr. right	2912	0685	0700	
030602-1C1*XXSR	1GN - C. panel right	0737	0685	0700	
030602-2C1C1*XXSR	2GN - C. panel right	1164	0685	0700	
030602-3C1C1C1*XXSR	3GN - C. panel right	1656	0685	0700	
030602-4C1C1C1C1*XXSR	4GN - C. panel right	2148	0685	0700	
030602-5C1C1C1C1C1XXSR	5GN - C. panel right	2640	0685	0700	
030602-1C1*SL	1GN - Aggr. left	1009	0685	0700	
030602-2C1C1*SL	2GN - Aggr. left	1436	0685	0700	
030602-3C1C1C1*SL	3GN - Aggr. left	1928	0685	0700	
030602-4C1C1C1C1*SL	4GN - Aggr. left	2420	0685	0700	
030602-5C1C1C1C1C1SL	5GN - Aggr. left	2912	0685	0700	
030602-1C1*XXSL	1GN - C. panel left	0737	0685	0700	
030602-2C1C1*XXSL	2GN - C. panel left	1164	0685	0700	
030602-3C1C1C1*XXSL	3GN - C. panel left	1656	0685	0700	
030602-4C1C1C1C1*XXSL	4GN - C. panel left	2148	0685	0700	
030602-5C1C1C1C1C1XXSL	5GN - C. panel left	2640	0685	0700	



*Top plates are **not** included in standard configurations!
 ** Top plates are ordered separately in neutral equipment!

Lifting cooling table

CODE	TYPE	LENGTH	WIDTH	HEIGHT	PRICE
030602-1C1*SRXXJY	1GN - Aggr. right	1109	0685	0700+140-220	
030602-2C1C1*SRXXJY	2GN - Aggr. right	1536	0685	0700+140-220	
030602-3C1C1C1*SRXXJY	3GN - Aggr. right	2028	0685	0700+140-220	
030602-4C1C1C1C1*SRXXJY	4GN - Aggr. right	2520	0685	0700+140-220	
030602-5C1C1C1C1C1SRXXJY	5GN - Aggr. right	3012	0685	0700+140-220	
030602-1C1*XXSRJY	1GN - C. panel right	0837	0685	0700+140-220	
030602-2C1C1*XXSRJY	2GN - C. panel right	1264	0685	0700+140-220	
030602-3C1C1C1*XXSRJY	3GN - C. panel right	1756	0685	0700+140-220	
030602-4C1C1C1C1*XXSRJY	4GN - C. panel right	2248	0685	0700+140-220	
030602-5C1C1C1C1C1XXSRJY	5GN - C. panel right	2740	0685	0700+140-220	
030602-1C1*SLXXJY	1GN - Aggr. left	1109	0685	0700+140-220	
030602-2C1C1*SLXXJY	2GN - Aggr. left	1536	0685	0700+140-220	
030602-3C1C1C1*SLXXJY	3GN - Aggr. left	2028	0685	0700+140-220	
030602-4C1C1C1C1*SLXXJY	4GN - Aggr. left	2520	0685	0700+140-220	
030602-5C1C1C1C1C1SLXXJY	5GN - Aggr. left	3012	0685	0700+140-220	
030602-1C1*XXSLJY	1GN - C. panel left	0837	0685	0700+140-220	
030602-2C1C1*XXSLJY	2GN - C. panel left	1264	0685	0700+140-220	
030602-3C1C1C1*XXSLJY	3GN - C. panel left	1756	0685	0700+140-220	
030602-4C1C1C1C1*XXSLJY	4GN - C. panel left	2248	0685	0700+140-220	
030602-5C1C1C1C1C1XXSLJY	5GN - C. panel left	2740	0685	0700+140-220	



*Top plates are **not** included in standard configurations!
 ** Top plates are ordered separately in neutral equipment!

Renders & Drawings



Drawers 100 + 150

€ xxx



Drawers 150 + 150

€ xxx



Door

€ xxx



Ladder

€ xxx



Perforated shelf

€ xxx

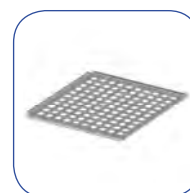

Grate shelf

€ xxx

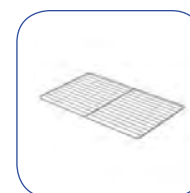

Configuration Example

Standard configuration example.
030603-3D1C1D1*SRXX46

- 030603 - Lowered cooling table GN
- 3 - Type: 3GN
- D1 - 1GN: 100+150
- C1 - 2GN: Door + sliders
- D1 - 3GN: 100+150
- * - The rest of GN chambers: Nothing
- SR - Aggregate: Standard aggregate
- XX - Control panel: Without
- 46 - Height: 460mm

Configuration Table

Type	1. GN	2. GN	3. GN	4. GN	5. GN	Aggregate	Control panel	Height	Legs	Lifting	Plinth	Waterproof Aggr. / C. panel
1	1GN D1 100+150	D1 100+150	D1 100+150	D1 100+150	D1 100+150	SR Standard right	SR Standard right	46 460mm	R Rounded	Y Yes	10 100mm	W Waterproof
2	2GN D2 150+150	D2 150+150	D2 150+150	D2 150+150	D2 150+150	MR Minimal right	MR Minimal right	52 520mm	J Square tub	X No	15 150mm	X Without
3	3GN C1 Door + sliders	C1 Door + sliders	C1 Door + sliders	C1 Door + sliders	C1 Door + sliders	SL Standard left	SL Standard left		X Without		16 160mm	
4	4GN C2 2x Door + sliders	C2 2x Doors + sliders	C2 2x Doors + sliders	C2 2x Doors + sliders	C2 2x Doors + sliders	ML Minimal left	ML Minimal left				17 170mm	
5	5GN	XX Nothing	XX Nothing	XX Nothing	XX Nothing	VL Cooling tub left	XX Without contr.				XX Without	
						VR Cooling tub right						
						XX Without agg.						

Lowered cooling table 460 - technical drawings

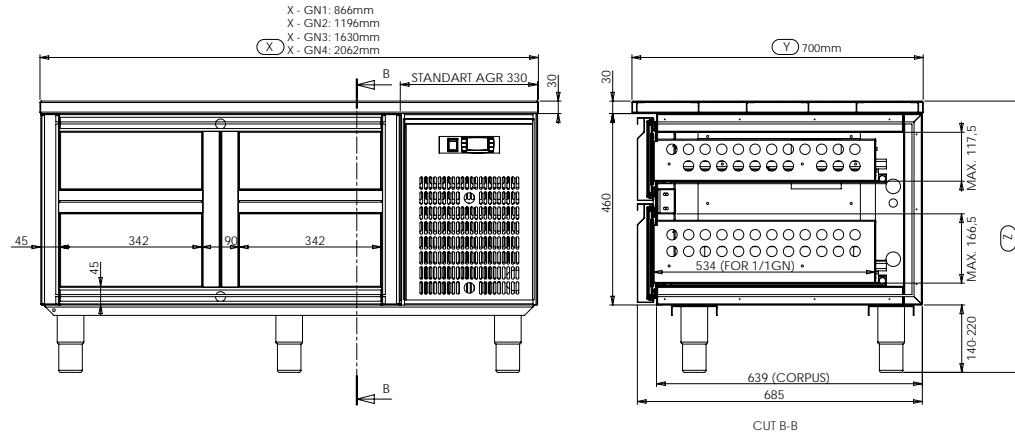

Lowered cooling table 520 - technical drawings

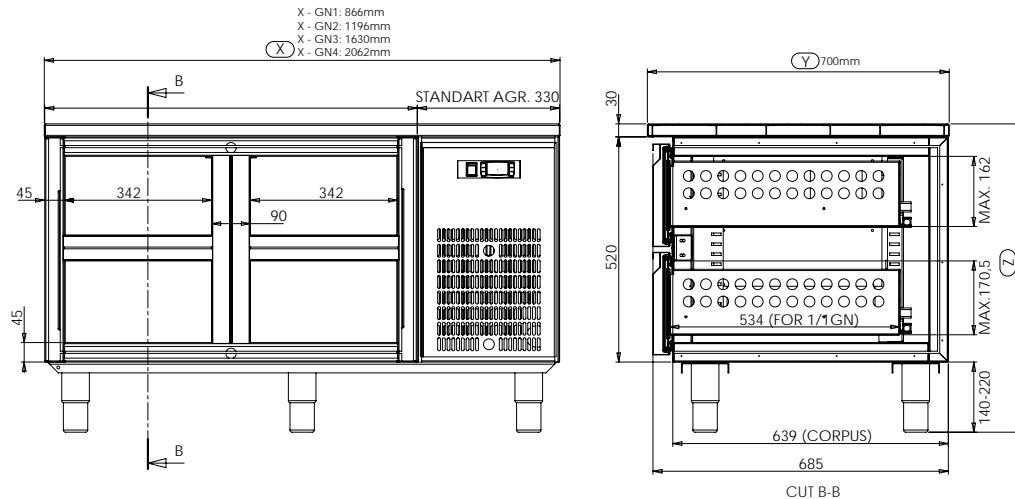

Lowered cooling tables

CODE (choose between 46 or 52)	TYPE	LENGTH	WIDTH	HEIGHT	
				460 mm	520 mm
030603-1D1*SRXX (46-52)	1GN - Aggr. right	0866	0685		
030603-2D1D1*SRXX(46-52)	2GN - Aggr. right	1196	0685		
030603-3D1D1D1*SRXX(46-52)	3GN - Aggr. right	1630	0685		
030603-4D1D1D1D1*SRXX(46-52)	4GN - Aggr. right	2062	0685		
030603-5D1D1D1D1D1SRXX(46-52)	5GN - Aggr. right	2460	0685		
030603-1D1*SLXX(46-52)	1GN - Aggr. left	0866	0685		
030603-2D1D1*SLXX(46-52)	2GN - Aggr. left	1196	0685		
030603-3D1D1D1*SLXX(46-52)	3GN - Aggr. left	1630	0685		
030603-4D1D1D1D1*SLXX(46-52)	4GN - Aggr. left	2062	0685		
030603-5D1D1D1D1D1SLXX(46-52)	5GN - Aggr. left	2460	0685		
030603-1D1*XXSR (46-52)	1GN - C. panel right	0716	0685		
030603-2D1D1*XXSR (46-52)	2GN - C. panel right	1046	0685		
030603-3D1D1D1*XXSR (46-52)	3GN - C. panel right	1480	0685		
030603-4D1D1D1D1*XXSR (46-52)	4GN - C. panel right	1912	0685		
030603-5D1D1D1D1D1XXSR (46-52)	5GN - C. panel right	2340	0685		
030603-1D1*XXSL (46-52)	1GN - C. panel left	0716	0685		
030603-2D1D1*XXSL (46-52)	2GN - C. panel left	1046	0685		
030603-3D1D1D1*XXSL (46-52)	3GN - C. panel left	1480	0685		
030603-4D1D1D1D1*XXSL (46-52)	4GN - C. panel left	1912	0685		
030603-5D1D1D1D1D1XXSL (46-52)	5GN - C. panel left	2340	0685		

*Top plates are **not** included in standard configurations!

** Top plates are ordered separately in neutral equipment!



Lowered cooling tables without aggregate and control panel

CODE	TYPE	LENGTH	WIDTH	HEIGHT	PRICE
030603-1D1*XXXX46	1GN - 460mm	0536	0685	0460	
030603-2D1D1*XXXX46	2GN - 460mm	0866	0685	0460	
030603-3D1D1D1*XXXX46	3GN - 460mm	1300	0685	0460	
030603-4D1D1D1D1*XXXX46	4GN - 460mm	1732	0685	0460	
030603-5D1D1D1D1D1XXXX46	5GN - 460mm	2160	0685	0460	
030603-1D1*XXXX52	1GN - 520mm	0536	0685	0460	
030603-2D1D1*XXXX52	2GN - 520mm	0866	0685	0460	
030603-3D1D1D1*XXXX52	3GN - 520mm	1300	0685	0460	
030603-4D1D1D1D1*XXXX52	4GN - 520mm	1732	0685	0460	
030603-5D1D1D1D1D1XXXX52	5GN - 520mm	2160	0685	0460	

*Top plates are **not** included in standard configurations!

** Top plates are ordered separately in neutral equipment!



Renders & Drawings



Configuration Example

Standard configuration example.
030604-2GND1D1*SR

- 030604 - Sushi
- 2GN - Type: 2GN
- D1 - 1. GN: 1/2 + 1/2
- D1 - 2. GN: 1/2 + 1/2
- * - The rest of GNs nothing
- SR - Aggregate: Standard right

Configuration Table

Type	1. GN	2. GN	3. GN	Aggregate	Control panel	Legs	Lifting	Plinth	Waterproof Aggr. / C. panel
1	1GN D1 1/2+1/2	D1 1/2+1/2	D1 1/2+1/2	SR Standard right	SR Standard right	R Rounded	Y Yes	10 100mm	W Waterproof
2	2GN D2 1/3+1/3+1/3	D2 1/3+1/3+1/3	D2 1/3+1/3+1/3	MR Minimal right	MR Minimal right	J Square tub	X No	15 150mm	X Without
3	3GN C1 Door + sliders	C1 Door + sliders	C1 Door + sliders	SL Standard left	SL Standard left	X Without		16 160mm	
A	Atypical C2 2xDoors + sliders	C2 2xDoors + sliders	C2 2xDoors + sliders	ML Minimal left	ML Minimal left			17 170mm	
		XX Nothing	XX Nothing	VL Cooling tub left	XX Without contr.			XX Without	
				VR Cooling tub right					
				XX Without agg.					

Drawers 1/2

€ xxx



Drawers 1/3

€ xxx



Door

€ xxx



Glass door

€ xxx



Grate shelf

€ xxx

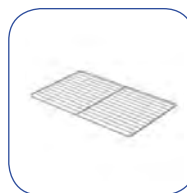

Perforated shelf

€ xxx

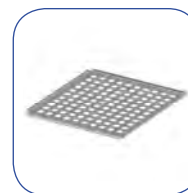

Ladder

€ xxx



Sushi module

CODE	TYPE	LENGTH	WIDTH	HEIGHT	PRICE
030604-3C1C1C1SRXXJ	3GN	2267	0700	1250	

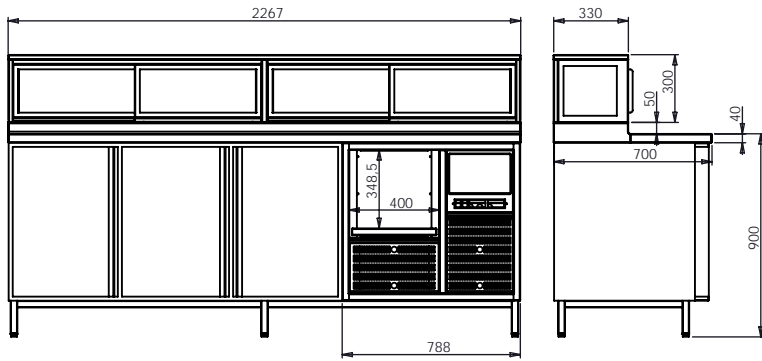

Renders & Drawings



Drawers 1/2

€ xxx



Drawers 1/3

€ xxx



Door

€ xxx



Glass door

€ xxx



Grate shelf

€ xxx

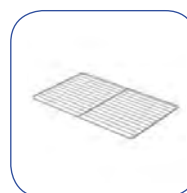

Perforated shelf

€ xxx

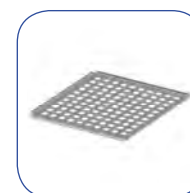

Ladder

€ xxx



Configuration Example

Standard configuration example.
030701-3ND1D1D1*SR

- 030701 - Freezing table GN
- 3 - Type: 3GN
- N - Lifting: No
- D1 - 1GN: 1/2+1/2
- D1 - 2GN: 1/2+1/2
- D1 - 3GN: 1/2+1/2
- * - The rest of GNs chambers: Nothing
- SR - Aggregate: Standard aggregate

Configuration Table

Type	Lifting	1. GN	2. GN	3. GN	4. GN	5. GN	Aggregate	Control panel	Legs	Lifting	Plinth	Waterproof Aggr. / C. panel											
1	1GN	Y	Yes	D1	1/2+1/2	D1	1/2+1/2	D1	1/2+1/2	D1	1/2+1/2	SR	Standard right	SR	Standard right	R	Rounded	Y	Yes	10	100mm	W	Waterproof
2	2GN	N	No	D2	1/3+1/3+1/3	D2	1/3+1/3+1/3	D2	1/3+1/3+1/3	D2	1/3+1/3+1/3	MR	Minimal right	MR	Minimal right	J	Square tub	X	No	15	150mm	X	Without
3	3GN			C1	Door + sliders	C1	Door + sliders	C1	Door + sliders	C1	Door + sliders	SL	Standard left	SL	Standard left	X	Nothing			16	160mm		
4	4GN			C2	2x Doors + sliders	C2	2x Doors + sliders	C2	2x Doors + sliders	C2	2x Doors + sliders	ML	Minimal left	ML	Minimal left					17	170mm		
5	5GN			XX	Nothing	XX	Nothing	XX	Nothing	XX	Nothing	VL	Cooling tub left	XX	Without contr.					XX	Nothing		
												VR	Cooling tub right										
												XX	Without aggr.										

Technical drawings

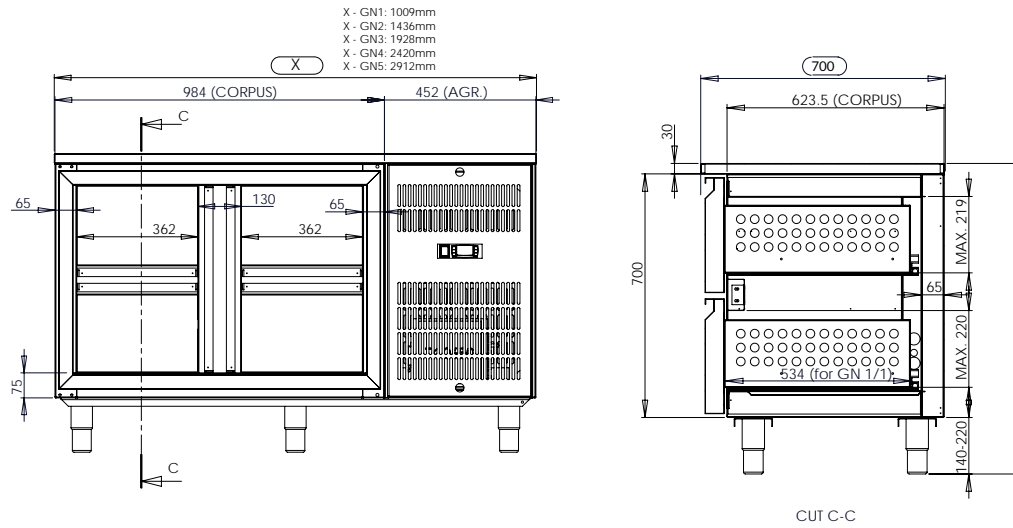

Doors and aggregate variations

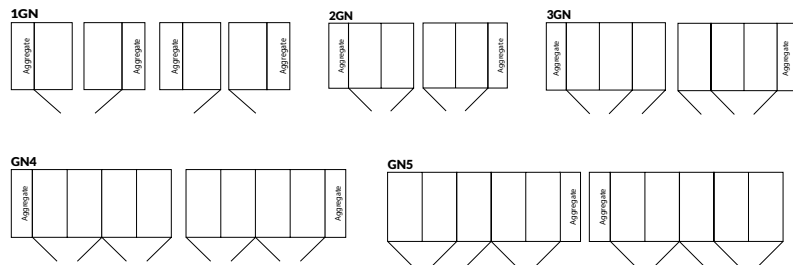

Types of control panels and aggregates

Aggregate MIN.
270 mm



Aggregate STANDARD
452 mm



Control panel MIN.
100 mm



Control panel STANDARD
180 mm



Freezing tables GN without aggregate and control panel

CODE	TYPE	LENGTH	WIDTH	HEIGHT	PRICE
030701-1C1	1GN	0557	0685	0700	
030701-2C1C1	2GN	0984	0685	0700	
030701-3C1C1C1	3GN	1476	0685	0700	
030701-4C1C1C1C1	4GN	1968	0685	0700	
030701-5C1C1C1C1C1	5GN	2460	0685	0700	



*Top plates are **not** included in standard configurations!
 ** Top plates are ordered separately in neutral equipment!

Lifting freezing tables GN without aggregate and control panel

CODE	TYPE	LENGTH	WIDTH	HEIGHT	PRICE
030701-1C1*XXXXJY	1GN	0657	0685	0700+140-220	
030701-2C1C1*XXXXJY	2GN	1084	0685	0700+140-220	
030701-3C1C1C1*XXXXJY	3GN	1576	0685	0700+140-220	
030701-4C1C1C1C1*XXXXJY	4GN	2068	0685	0700+140-220	
030701-5C1C1C1C1C1*XXXXJY	5GN	2560	0685	0700+140-220	



*Top plates are **not** included in standard configurations!
 ** Top plates are ordered separately in neutral equipment!

Freezing tables GN

CODE	TYPE	LENGTH	WIDTH	HEIGHT	PRICE
030701-1C1*SR	1GN - Aggr. right	1009	0685	0700	
030701-2C1C1*SR	2GN - Aggr. right	1436	0685	0700	
030701-3C1C1C1*SR	3GN - Aggr. right	1928	0685	0700	
030701-4C1C1C1C1*SR	4GN - Aggr. right	2420	0685	0700	
030701-5C1C1C1C1C1SR	5GN - Aggr. right	2912	0685	0700	
030701-1C1*XXSR	1GN - C. panel right	737	0685	0700	
030701-2C1C1*XXSR	2GN - C. panel right	1164	0685	0700	
030701-3C1C1C1*XXSR	3GN - C. panel right	1656	0685	0700	
030701-4C1C1C1C1*XXSR	4GN - C. panel right	2148	0685	0700	
030701-5C1C1C1C1C1XXSR	5GN - C. panel right	2640	0685	0700	
030701-1C1*SL	1GN - Aggr. left	1009	0685	0700	
030701-2C1C1*SL	2GN - Aggr. left	1436	0685	0700	
030701-3C1C1C1*SL	3GN - Aggr. left	1928	0685	0700	
030701-4C1C1C1C1*SL	4GN - Aggr. left	2420	0685	0700	
030701-5C1C1C1C1C1SL	5GN - Aggr. left	2912	0685	0700	
030701-1C1*XXSL	1GN - C. panel left	737	0685	0700	
030701-2C1C1*XXSL	2GN - C. panel left	1164	0685	0700	
030701-3C1C1C1*XXSL	3GN - C. panel left	1656	0685	0700	
030701-4C1C1C1C1*XXSL	4GN - C. panel left	2148	0685	0700	
030701-5C1C1C1C1C1XXSL	5GN - C. panel left	2640	0685	0700	



*Top plates are **not** included in standard configurations!
 ** Top plates are ordered separately in neutral equipment!

Lifting freezing tables GN

CODE	TYPE	LENGTH	WIDTH	HEIGHT	PRICE
030701-1C1*SRXXJY	1GN - Aggr. right	1109	0685	0700+140-220	€ 123.456
030701-2C1C1*SRXXJY	2GN - Aggr. right	1536	0685	0700+140-220	
030701-3C1C1C1*SRXXJY	3GN - Aggr. right	2028	0685	0700+140-220	
030701-4C1C1C1C1*SRXXJY	4GN - Aggr. right	2520	0685	0700+140-220	
030701-5C1C1C1C1C1SRXXJY	5GN - Aggr. right	3012	0685	0700+140-220	
030701-1C1*XXSRJY	1GN - C. panel right	0837	0685	0700+140-220	
030701-2C1C1*XXSRJY	2GN - C. panel right	1264	0685	0700+140-220	
030701-3C1C1C1*XXSRJY	3GN - C. panel right	1756	0685	0700+140-220	
030701-4C1C1C1C1*XXSRJY	4GN - C. panel right	2248	0685	0700+140-220	
030701-5C1C1C1C1C1XXSRJY	5GN - C. panel right	2740	0685	0700+140-220	
030701-1C1*SLXXJY	1GN - Aggr. left	1109	0685	0700+140-220	
030701-2C1C1*SLXXJY	2GN - Aggr. left	1536	0685	0700+140-220	
030701-3C1C1C1*SLXXJY	3GN - Aggr. left	2028	0685	0700+140-220	
030701-4C1C1C1C1*SLXXJY	4GN - Aggr. left	2520	0685	0700+140-220	
030701-5C1C1C1C1C1SLXXJY	5GN - Aggr. left	3012	0685	0700+140-220	
030701-1C1*XXSLJY	1GN - C. panel left	0837	0685	0700+140-220	
030701-2C1C1*XXSLJY	2GN - C. panel left	1264	0685	0700+140-220	
030701-3C1C1C1*XXSLJY	3GN - C. panel left	1756	0685	0700+140-220	
030701-4C1C1C1C1*XXSLJY	4GN - C. panel left	2248	0685	0700+140-220	
030701-5C1C1C1C1C1XXSLJY	5GN - C. panel left	2740	0685	0700+140-220	



*Top plates are **not** included in standard configurations!
 ** Top plates are ordered separately in neutral equipment!

Renders & Drawings



Configuration Example

Standard configuration example.
030802-3D1D1D1*SR

- 030802 - Freezing table GN
- 3 - Type: 3GN
- D1 - 1GN: 100+150
- D1 - 2GN: 100+150
- D1 - 3GN: 100+150
- * - The rest of GNs: Nothing
- SR - Aggregate: Standard aggregate

Drawers 100+150

€xxx



Drawers 150 + 150

€xxx



Door

€xxx



Ladder

€xxx



Perforated shelf

€xxx

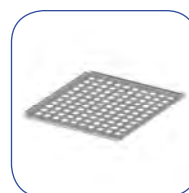

Grate shelf

€xxx

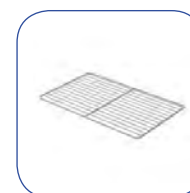

Configuration Table

Type	Lifting	1. GN	2. GN	3. GN	4. GN	5. GN	Aggregate	Control panel	Height	Legs	Plinth	Waterproof Aggr. / C. panel		
1	1GN	Y Yes	D1 100+150	D1 100+150	D1 100+150	D1 100+150	D1 100+150	D1 100+150	SR Standard right	SR Standard right	46 460mm	R Rounded	10 100mm	W Waterproof
2	2GN	N No	D2 150+150	D2 150+150	D2 150+150	D2 150+150	D2 150+150	D2 150+150	MR Minimal right	MR Minimal right	52 520mm	J Square tub	15 150mm	X Without
3	3GN		C1 Door + sliders	C1 Door + sliders	C1 Door + sliders	C1 Door + sliders	C1 Door + sliders	C1 Door + sliders	SL Standard left	SL Standard left		X Nothing	16 160mm	
4	4GN		C2 2x Doors + sliders	C2 2x Doors + sliders	C2 2x Doors + sliders	C2 2x Doors + sliders	C2 2x Doors + sliders	C2 2x Doors + sliders	ML Minimal left	ML Minimal left			17 170mm	
5	5GN			XX Nothing	XX Nothing	XX Nothing	XX Nothing	XX Nothing	VL Cooling tub left	XX Without contr.				
									VR Cooling tub right					
									XX Without agg.					

Lowered freezing table 460 - technical drawings

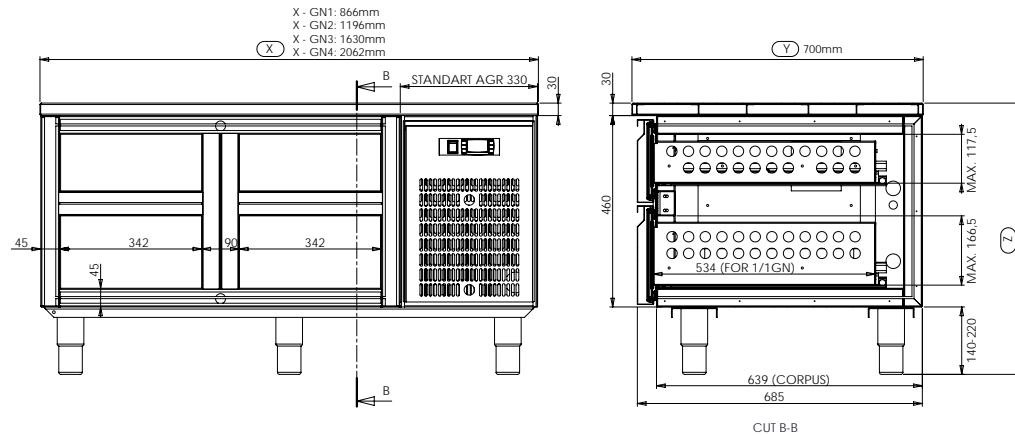

Lowered freezing table 520 - technical drawings

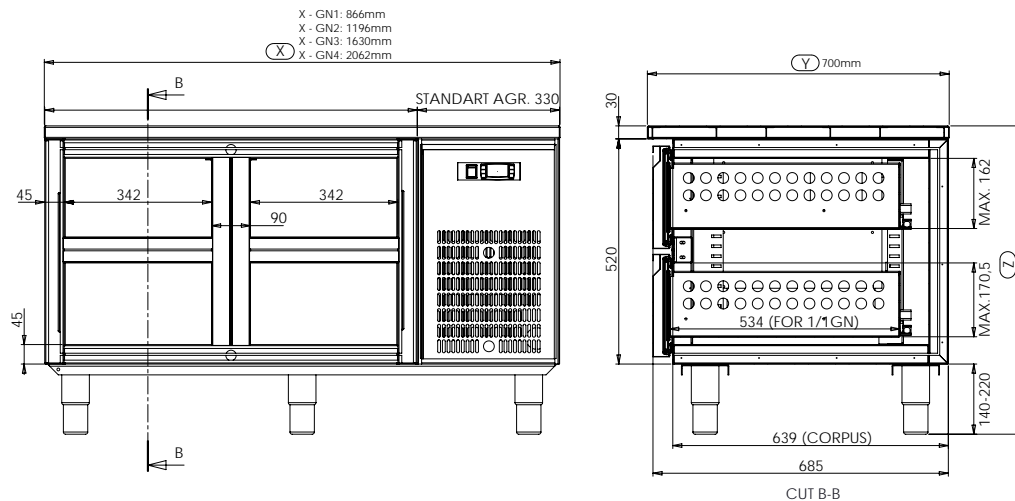

Lowered freezing tables

CODE (choose between 46 or 52)	TYPE	LENGTH	WIDTH	HEIGHT	
				460 mm	520 mm
030702-1D1*SRXX (46-52)	1GN - Aggr. right	0866	0685		
030702-2D1D1*SRXX (46-52)	2GN - Aggr. right	1196	0685		
030702-3D1D1D1*SRXX (46-52)	3GN - Aggr. right	1630	0685		
030702-4D1D1D1D1*SRXX (46-52)	4GN - Aggr. right	2062	0685		
030702-5D1D1D1D1D1SRXX (46-52)	5GN - Aggr. right	2460	0685		
030702-1D1*SLXX (46-52)	1GN - Aggr. left	0866	0685		
030702-2D1D1*SLXX (46-52)	2GN - Aggr. left	1196	0685		
030702-3D1D1D1*SLXX (46-52)	3GN - Aggr. left	1630	0685		
030702-4D1D1D1D1*SLXX (46-52)	4GN - Aggr. left	2062	0685		
030702-5D1D1D1D1D1SLXX (46-52)	5GN - Aggr. left	2460	0685		
030702-1D1*XXSR (46-52)	1GN - C. panel right	0716	0685		
030702-2D1D1*XXSR (46-52)	2GN - C. panel right	1046	0685		
030702-3D1D1D1*XXSR (46-52)	3GN - C. panel right	1480	0685		
030702-4D1D1D1D1*XXSR (46-52)	4GN - C. panel right	1912	0685		
030702-5D1D1D1D1D1XXSR (46-52)	5GN - C. panel right	2340	0685		
030702-1D1*XXSL (46-52)	1GN - C. panel left	0716	0685		
030702-2D1D1*XXSL (46-52)	2GN - C. panel left	1046	0685		
030702-3D1D1D1*XXSL (46-52)	3GN - C. panel left	1480	0685		
030702-4D1D1D1D1*XXSL (46-52)	4GN - C. panel left	1912	0685		
030702-5D1D1D1D1D1XXSL (46-52)	5GN - C. panel left	2340	0685		



*Top plates are **not** included in standard configurations!
 ** Top plates are ordered separately in neutral equipment!

Lowered freezing tables without aggregate and control panel

CODE	TYPE	LENGTH	WIDTH	PRICE
030702-1D1*XXXX46	1GN - 460mm	0536	0685	
030702-2D1D1*XXXX46	2GN - 460mm	0866	0685	
030702-3D1D1D1*XXXX46	3GN - 460mm	1300	0685	
030702-4D1D1D1D1*XXXX46	4GN - 460mm	1732	0685	
030702-5D1D1D1D1D1XXXX46	5GN - 460mm	2160	0685	
030702-1D1*XXXX52	1GN - 520mm	0536	0685	
030702-2D1D1*XXXX52	2GN - 520mm	0866	0685	
030702-3D1D1D1*XXXX52	3GN - 520mm	1300	0685	
030702-4D1D1D1D1*XXXX52	4GN - 520mm	1732	0685	
030702-5D1D1D1D1D1XXXX52	5GN - 520mm	2160	0685	



*Top plates are **not** included in standard configurations!
 ** Top plates are ordered separately in neutral equipment!

Renders & Drawings



Configuration Table

Dimension of GN	Orientation of GN	Pieces of GN	Cover
21 GN 2/1	W Longer side in width direction „Y“	1 1pc	O Opened
11 GN 1/1	L Longer side in length direction „X“	2 2pcs	C Covered
24 GN 2/4		3 3pcs	
23 GN 2/3		4 4pcs	
12 GN 1/2		5 5pcs	
13 GN 1/3		6 6pcs	
14 GN 1/4			
16 GN 1/6			
19 GN 1/9			
AA Atypical			

Configuration Example

Standard configuration example.
0308-21W2C

0308 - Cooling extension
W - Longer side in width direction „Y“
2 - 2 GN
C - Covered

Renders & Drawings



Configuration Table

Type	Dimension of GN	Orientation of GN	Pieces of GN	Cover
IT	21 GN 2/1	W Longer side in width direction „Y“	1 1pc	O Opened
	11 GN 1/1	L Longer side in length direction „X“	2 2pcs	C Covered
	24 GN 2/4		3 3pcs	
	23 GN 2/3		4 4pcs	
	12 GN 1/2		5 5pcs	
	13 GN 1/3		6 6pcs	
	14 GN 1/4		7 7pcs	
	16 GN 1/6		8 8pcs	
	19 GN 1/9		9 9pcs	
	AA Atypical			

Configuration Example

Standard configuration example.
0309-SU

0309 - Cooling extension
SU - Sushi

Insulated tub extension

CODE	PRICE
IT	

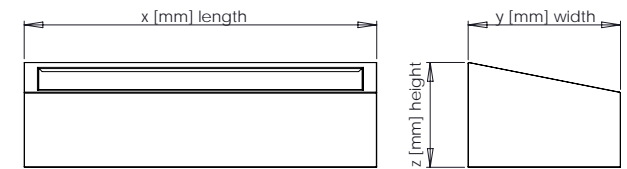

Renders & Drawings



Configuration Table

Type	Size	
1DB	1 Dustbin	S Small
2DB	2 Dustbin	L Large
3DB	3 Dustbin	

Configuration Example

Standard configuration example.
0310-1DBS

- 0310 - Cooling box for dustbin
- 1DB - 1 Dustbin
- S - Small

1x Dustbin - small

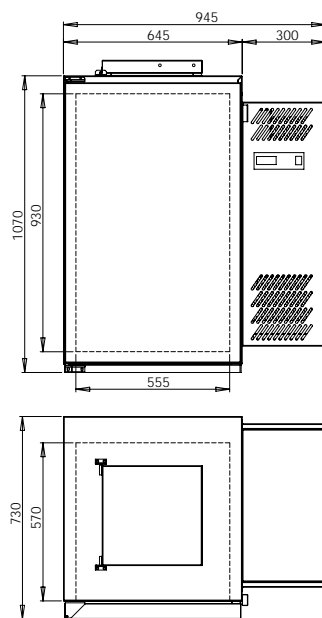

CODE	PRICE
1DBS	

2x Dustbin - small

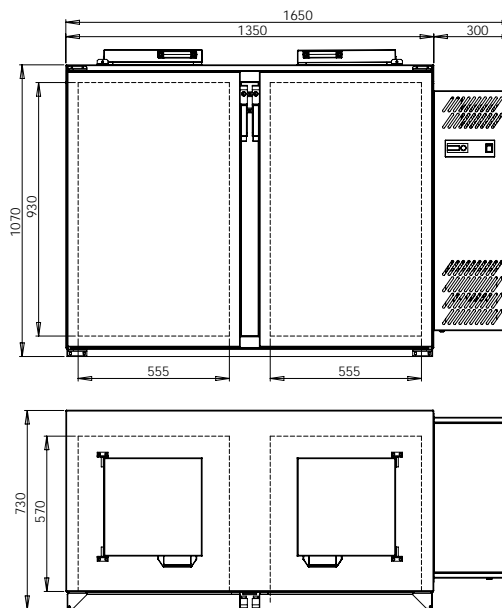

CODE	PRICE
2DBS	

3x Dustbin - small

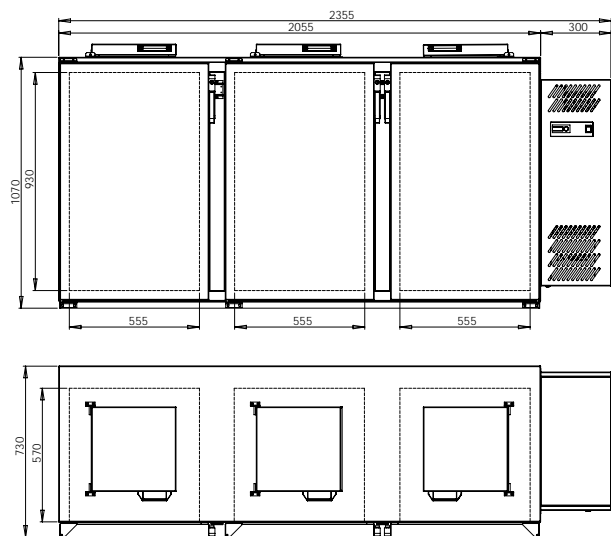

CODE	PRICE
3DBS	

2x Dustbin - large

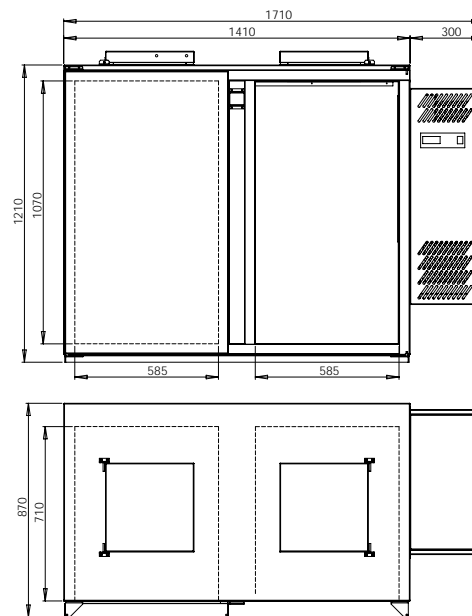

CODE	PRICE
2DBL	

1x Dustbin - large

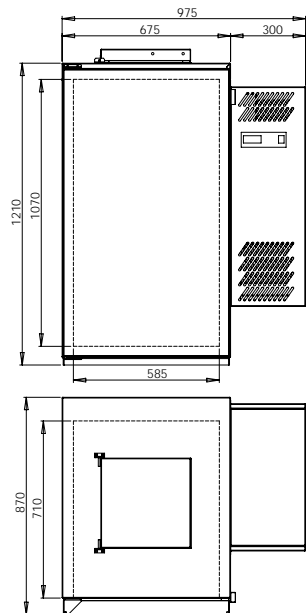

CODE	PRICE
1DBL	

3x Dustbin - large

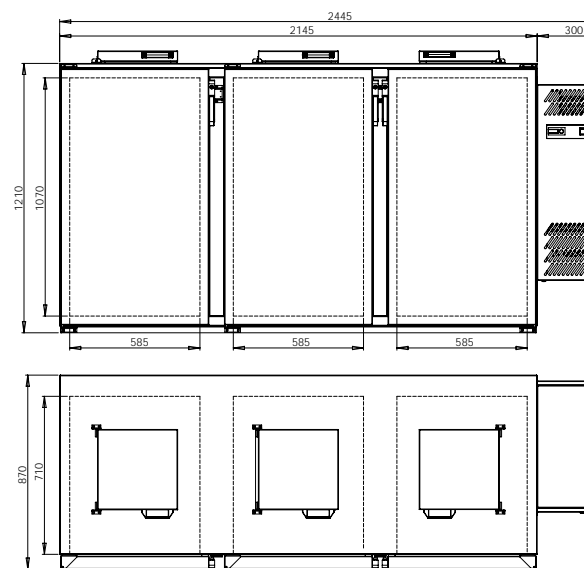

CODE	PRICE
3DBL	



1. Neutral Equipment
2. Heating Technique
3. Cooling Technique
4. Trolleys

GASTRO PRODUCTION s.r.o.

PRODUCT CATALOGUE 2018

ZEMEDELSKA 500,
373 81, KAMENNY UJEZD
CZECHIA

www.gastro.cz